



Contact characteristics

Number of poles	Nr.	4
Rated insulation voltage U _i IEC/EN	V	690
Rated impulse withstand voltage U _{imp}	kV	6
Operational frequency	min	Hz 25
	max	Hz 400
IEC Conventional free air thermal current I _{th} ≤ 40°C	A	56
Operational current I _e	AC-1 (≤40°C)	A 56
	AC-1 (≤40°C) with 16mm ² wire and fork end lug	A 60
	AC-1 (≤55°C)	A 45
	AC-1 (≤55°C) with 16mm ² wire and fork end lug	A 48
	AC-1 (≤70°C)	A 40
	AC-1 (≤70°C) with 16mm ² wire and fork end lug	A 42
	AC-3 (≤440V ≤55°C)	A 38
Rated operational power AC-1 (T≤40°C)	AC-4 (400V)	A 15.5
	230V	kW 21
	400V	kW 36
	500V	kW 45
	690V	kW 62
Short-time allowable current for 10s (IEC/EN60947-1)	A	320
Protection fuse	gG (IEC)	A 63
	aM (IEC)	A 40
Making capacity (RMS value)	A	380
Breaking capacity at voltage	440V	A 304
	500V	A 240
	690V	A 192
Resistance per pole (average value)	mΩ	2
Power dissipation per pole (average value)	I _{th}	W 6
	AC-3	W 2.9
Tightening torque for terminals	min	Nm 2.5
	max	Nm 3
	min	lbin 1.8
	max	lbin 2.2
Tightening torque for coil terminal	min	Nm 0.8
	max	Nm 1
	min	lbin 0.8
	max	lbin 0.74

Max number of wires simultaneously connectable	Nr.	2	
Conductor section	AWG/Kcmil		
	max	6	
Flexible w/o lug conductor section	min	mm ²	2.5
	max	mm ²	16
Flexible c/w lug conductor section	min	mm ²	1
	max	mm ²	10
Flexible with insulated spade lug conductor section	min	mm ²	1
	max	mm ²	16
Power terminal protection according to IEC/EN 60529	IP20 when properly wired		
Cable stripping length	main circuit	mm	10
	command circuit	mm	8
Mechanical features			
Operating position	normal allowable	Vertical plan ±30°	
Fixing	Screw / DIN rail 35mm		
Weight	g	670	
Operations			
Mechanical life	cycles	20000000	
Electrical life	cycles	1400000	
Safety related data			
Performance level B10d according to EN/ISO 13489-1	rated load	cycles	1400000
	mechanical load	cycles	20000000
EMC compatibility	yes		
DC coil operating			
DC rated control voltage	V	220	
DC operating voltage	pick-up		
	min	%Us	80
	max	%Us	125
	drop-out		
	min	%Us	10
	max	%Us	40
Average coil consumption ≤20°C	in-rush	W	5.4
	holding	W	5.4
Max cycles frequency			
Mechanical operation	cycles/h	3600	
Operating times			
Average time for Us control	in AC		
	Closing NO		
	min	ms	8
	max	ms	24

Opening NO	min	ms	5
	max	ms	15
Closing NC	min	ms	9
	max	ms	20
Opening NC	min	ms	9
	max	ms	17
<hr/>			
in DC			
Closing NO	min	ms	54
	max	ms	66
Opening NO	min	ms	14
	max	ms	17
Closing NC	min	ms	23
	max	ms	28
Opening NC	min	ms	46
	max	ms	56

UL technical data

Rated operational voltage AC (UL)	V	600
Full-load current (FLA) for three-phase AC motor	at 480V	A 40
	at 600V	A 32

Yielded mechanical performance

for single-phase AC motor

110/120V	HP	3
230V	HP	7.5

for three-phase AC motor

200/208V	HP	10
220/240V	HP	15
460/480V	HP	30
575/600V	HP	30

General USE

Contactor

AC current	A	55
------------	---	----

Ambient conditions

Temperature

Operating temperature

min	°C	-50
max	°C	70

Storage temperature

min	°C	-60
max	°C	80

Max altitude

m	3000
---	------

Resistance & Protection

Pollution degree

3

Dimensions



Wiring diagrams

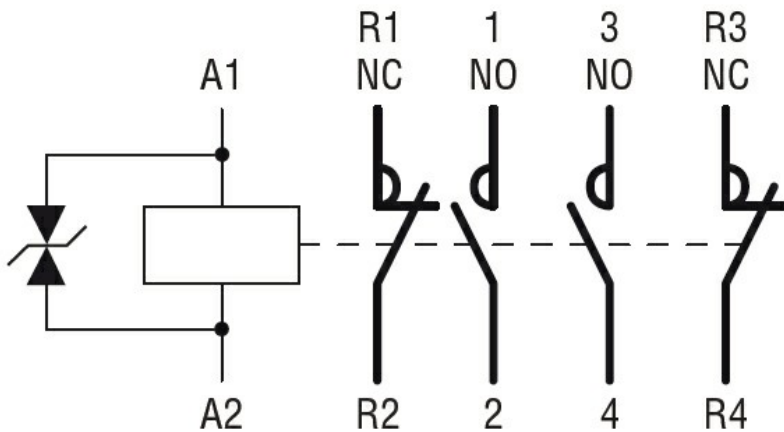

Certifications and compliance

Compliance

CSA C22.2 n° 60947-1

CSA C22.2 n° 60947-4-1

IEC/EN 60335-2-89

IEC/EN/BS 60947-1

IEC/EN/BS 60947-4-1

UL 60947-1

UL 60947-4-1

Certificates

CCC

CSA C22.2 n. 60335-2-40:22 LZGH A2L

CSA C22.2 No. 60335-2-89:21 LZGH A2L

cULus

EAC

UL 60335-2-40 LZGH A2L

UL 60335-2-89 LZGH A2L

ETIM classification

ETIM 8.0

EC000066 -
Power contactor,
AC switching