



Contact characteristics

Number of poles	Nr.	4
Rated insulation voltage U_i IEC/EN	V	500
Rated impulse withstand voltage U_{imp}	kV	6
Operational frequency	min	Hz 25
	max	Hz 400
IEC Conventional free air thermal current $I_{th} \leq 40^\circ\text{C}$	A	20
Operational current I_e	AC-1 ($\leq 40^\circ\text{C}$)	A 20
	AC-1 ($\leq 55^\circ\text{C}$)	A 18
	AC-1 ($\leq 70^\circ\text{C}$)	A 15
	AC-3 ($\leq 440\text{V} \leq 55^\circ\text{C}$)	A 9
	AC-4 (400V)	A 4
Rated operational power AC-1 ($T \leq 40^\circ\text{C}$)	230V	kW 8
	400V	kW 14
	500V	kW 16
Short-time allowable current for 10s (IEC/EN60947-1)	A	96
Protection fuse	gG (IEC)	A 20
	aM (IEC)	A 10
Making capacity (RMS value)	A	92
Breaking capacity at voltage	440V	A 72
	500V	A 72
Resistance per pole (average value)	m Ω	10
Power dissipation per pole (average value)	I_{th}	W 4
	AC-3	W 0.81
Tightening torque for terminals	min	Nm 0.8
	max	Nm 1
	min	lbin 9
	max	lbin 9
Tightening torque for coil terminal	min	Nm 0.8
	max	Nm 1
	min	lbin 9
	max	lbin 9
Max number of wires simultaneously connectable	Nr.	2
Conductor section	AWG/Kcmil	
	max	12
Flexible w/o lug conductor section		

	min	mm ²	0.8
	max	mm ²	2.5
Flexible c/w lug conductor section	min	mm ²	1.5
	max	mm ²	2.5
Flexible with insulated spade lug conductor section	min	mm ²	1.5
	max	mm ²	2.5
Power terminal protection according to IEC/EN 60529			IP00
Mechanical features			
Operating position	normal allowable		Vertical plan ±30°
Fixing			Screw / DIN rail 35mm
Weight		g	242
Auxiliary contact characteristics			
Thermal current I _{th}		A	10
IEC/EN 60947-5-1 designation			Q600
Operations			
Mechanical life		cycles	20000000
Electrical life		cycles	500000
Safety related data			
Performance level B10d according to EN/ISO 13489-1	rated load mechanical load	cycles	500000
		cycles	20000000
EMC compatibility			yes
DC coil operating			
DC rated control voltage		V	125
DC operating voltage			
pick-up	min	%Us	75
	max	%Us	115
drop-out	min	%Us	10
	max	%Us	25
Average coil consumption ≤20°C	in-rush holding	W	3.2
		W	3.2
Max cycles frequency			
Mechanical operation		cycles/h	3600
Operating times			
Average time for U _s control in AC	Closing NO	min	ms 12
		max	ms 21
	Opening NO	min	ms 9
		max	ms 18
	Closing NC	min	ms 17
		max	ms 26
	Opening NC		

		min	ms	7
		max	ms	17
in DC				
	Closing NO	min	ms	18
		max	ms	25
	Opening NO	min	ms	2
		max	ms	3
	Closing NC	min	ms	3
		max	ms	5
	Opening NC	min	ms	11
		max	ms	17

UL technical data

Full-load current (FLA) for three-phase AC motor

at 480V	A	7.6
at 600V	A	6.1

Yielded mechanical performance

for single-phase AC motor

110/120V	HP	0.5
230V	HP	1.5

for three-phase AC motor

200/208V	HP	2
220/240V	HP	3
460/480V	HP	5
575/600V	HP	5

General USE

Contactor

AC current	A	20
------------	---	----

Ambient conditions

Temperature

Operating temperature

min	°C	-50
max	°C	+70

Storage temperature

min	°C	-60
max	°C	+80

Max altitude

m	3000
---	------

Resistance & Protection

Pollution degree

3

Dimensions

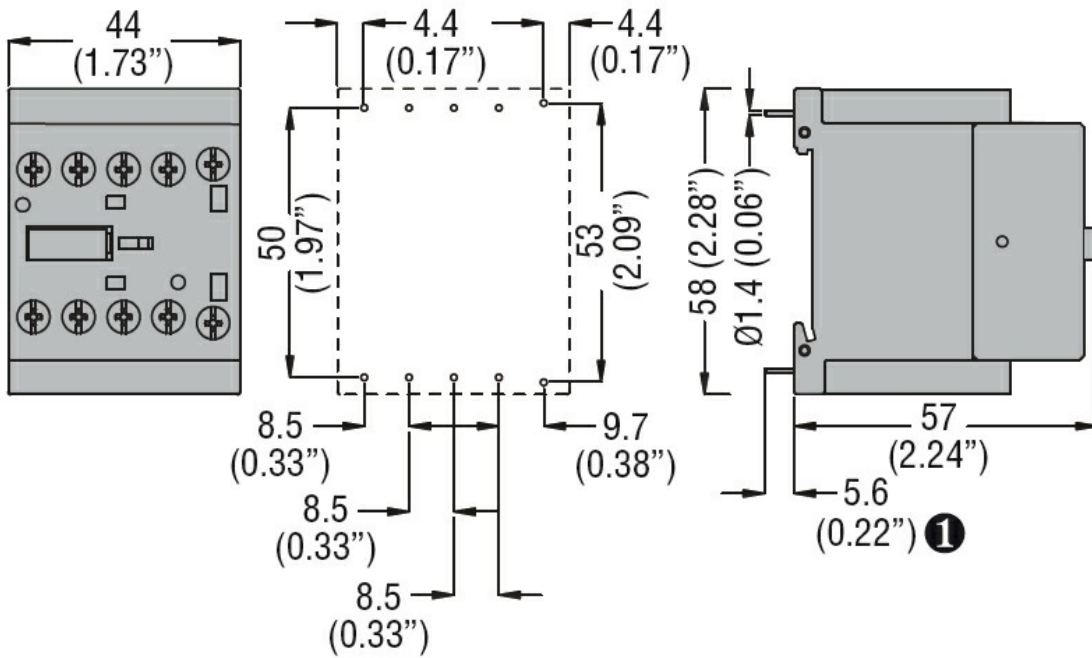

① Recommended PCB drillings 1.7-2mm.

Wiring diagrams

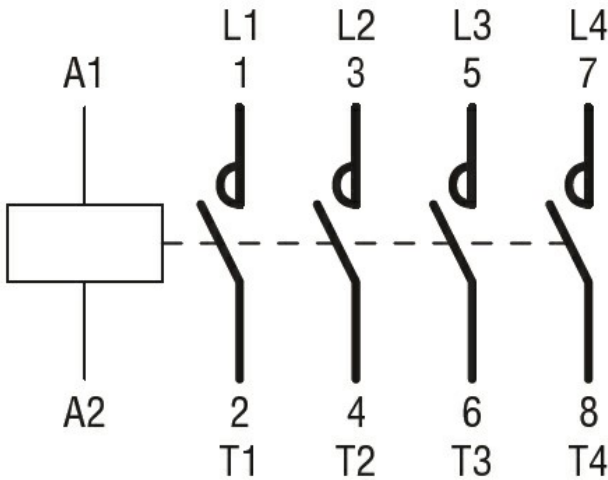

Certifications and compliance

Compliance

- CSA C22.2 n° 60947-1
- CSA C22.2 n° 60947-4-1
- IEC/EN 60947-1
- IEC/EN 60947-4-1
- UL 60947-1
- UL 60947-4-1

Certificates

- cURus
- EAC

ETIM classification

ETIM 8.0

EC000066 -
Power contactor,
AC switching