



Contact characteristics

Number of poles	Nr.	3
Rated insulation voltage U_i IEC/EN	V	500
Rated impulse withstand voltage U_{imp}	kV	6
Operational frequency	min	Hz 25
	max	Hz 400
IEC Conventional free air thermal current $I_{th} \leq 40^\circ\text{C}$	A	20
Operational current I_e	AC-1 ($\leq 40^\circ\text{C}$)	A 20
	AC-1 ($\leq 55^\circ\text{C}$)	A 18
	AC-1 ($\leq 70^\circ\text{C}$)	A 15
	AC-3 ($\leq 440\text{V} \leq 55^\circ\text{C}$)	A 9
	AC-4 (400V)	A 4
Rated operational power AC-3 ($T \leq 55^\circ\text{C}$)	230V	kW 2.2
	400V	kW 4
	415V	kW 4.3
	440V	kW 4.5
	500V	kW 5
Rated operational power AC-1 ($T \leq 40^\circ\text{C}$)	230V	kW 8
	400V	kW 14
	500V	kW 16
Short-time allowable current for 10s (IEC/EN60947-1)	A	96
Protection fuse	gG (IEC)	A 20
	aM (IEC)	A 10
Making capacity (RMS value)	A	92
Breaking capacity at voltage	440V	A 72
	500V	A 72
Resistance per pole (average value)	m Ω	10
Power dissipation per pole (average value)	I_{th}	W 4
	AC-3	W 0.81
Tightening torque for terminals	min	Nm 0.8
	max	Nm 1
	min	Ibin 9
	max	Ibin 9
Tightening torque for coil terminal	min	Nm 0.8
	max	Nm 1
	min	Ibin 9

	max	I _{bin}	9
Max number of wires simultaneously connectable		Nr.	2
Conductor section			
AWG/Kcmil	max		12
Flexible w/o lug conductor section	min	mm ²	0.8
	max	mm ²	2.5
Flexible c/w lug conductor section	min	mm ²	1.5
	max	mm ²	2.5
Flexible with insulated spade lug conductor section	min	mm ²	1.5
	max	mm ²	2.5
Power terminal protection according to IEC/EN 60529			IP00
Mechanical features			
Operating position	normal allowable		Vertical plan ±30°
Fixing			Screw / DIN rail 35mm
Weight		g	200
Auxiliary contact characteristics			
Thermal current I _{th}		A	10
IEC/EN 60947-5-1 designation			A600 - Q600
Operating current AC15	230V	A	3
	400V	A	1.9
	500V	A	1.4
Operating current DC12	110V	A	2.9
Operating current DC13	24V	A	2.9
	48V	A	1.4
	60V	A	1.1
	125V	A	0.3
	220V	A	0.1
	600V	A	0.6
Operations			
Mechanical life		cycles	20000000
Electrical life		cycles	500000
Safety related data			
Performance level B10d according to EN/ISO 13489-1	rated load	cycles	500000
	mechanical load	cycles	20000000
EMC compatibility			yes
AC coil operating			
Rated AC voltage at 60Hz		V	48
AC operating voltage			
of 60Hz coil powered at 60Hz pick-up	min	%U _s	75
	max	%U _s	115

drop-out

min	%Us	20
max	%Us	55

AC average coil consumption at 20°C

of 50/60Hz coil powered at 50Hz

in-rush	VA	30
holding	VA	4

of 50/60Hz coil powered at 60Hz

in-rush	VA	25
holding	VA	3

of 60Hz coil powered at 60Hz

in-rush	VA	30
holding	VA	4

Dissipation at holding ≤20°C 50Hz

W	0.95
---	------

Max cycles frequency

Mechanical operation

cycles/h	3600
----------	------

Operating times

Average time for Us control

in AC

Closing NO

min	ms	12
max	ms	21

Opening NO

min	ms	9
max	ms	18

Closing NC

min	ms	17
max	ms	26

Opening NC

min	ms	7
max	ms	17

in DC

Closing NO

min	ms	18
max	ms	25

Opening NO

min	ms	2
max	ms	3

Closing NC

min	ms	3
max	ms	5

Opening NC

min	ms	11
max	ms	17

UL technical data

Full-load current (FLA) for three-phase AC motor

at 480V	A	7.6
at 600V	A	6.1

Yielded mechanical performance

for single-phase AC motor

110/120V	HP	0.5
230V	HP	1.5

for three-phase AC motor

200/208V	HP	2
----------	----	---

220/240V	HP	3
460/480V	HP	5
575/600V	HP	5

General USE

Contactor

AC current A 20

Contact rating of auxiliary contacts according to UL

A600 - Q600

Ambient conditions

Temperature

Operating temperature

min	°C	-50
max	°C	+70

Storage temperature

min	°C	-60
max	°C	+80

Max altitude

m 3000

Resistance & Protection

Pollution degree

3

Dimensions

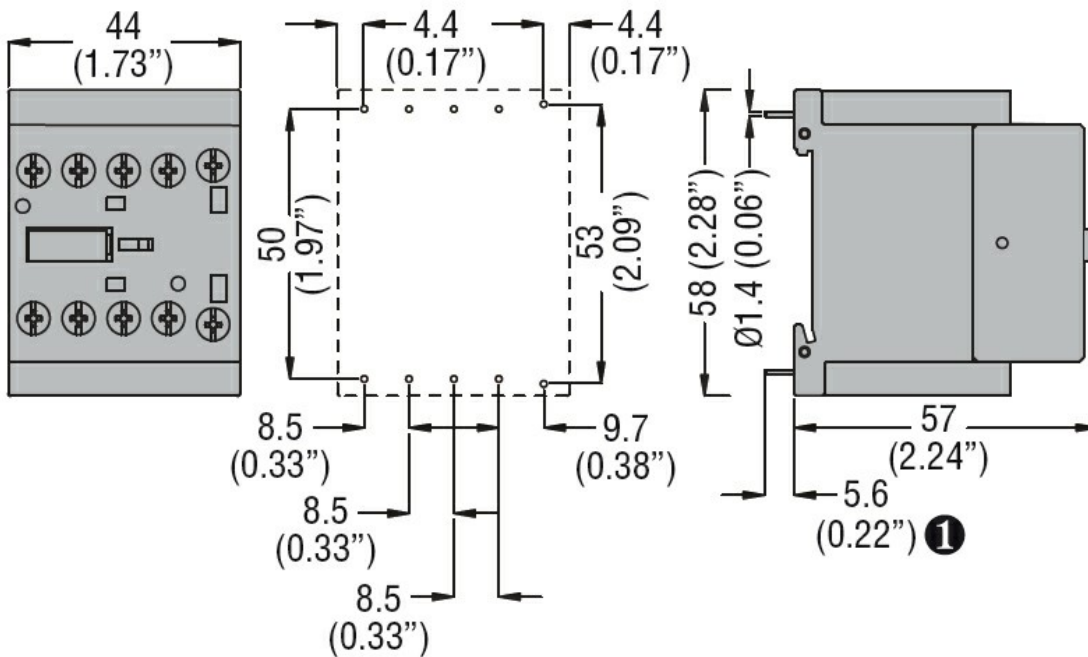

① Recommended PCB drillings 1.7-2mm.

Wiring diagrams

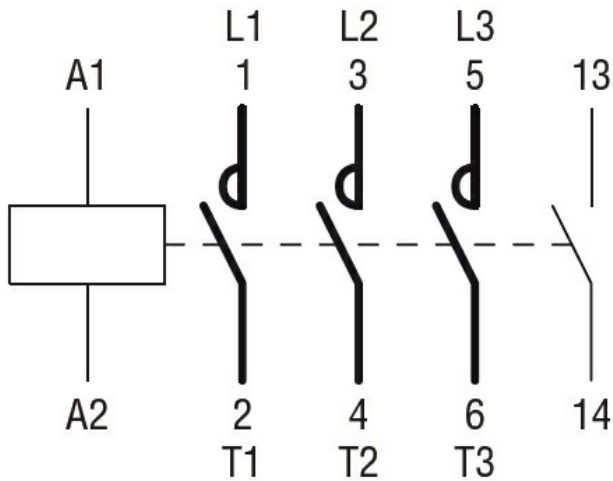

Certifications and compliance

Compliance

CSA C22.2 n° 60947-1

CSA C22.2 n° 60947-4-1

IEC/EN 60947-1

IEC/EN 60947-4-1

UL 60947-1

UL 60947-4-1

Certificates

cURus

EAC

ETIM classification

ETIM 8.0

EC000066 -
 Power contactor,
 AC switching