



Contact characteristics

Number of poles	Nr.	3
Rated insulation voltage U_i IEC/EN	V	690
Rated impulse withstand voltage U_{imp}	kV	6
Operational frequency	min	Hz 25
	max	Hz 400
IEC Conventional free air thermal current $I_{th} \leq 40^\circ\text{C}$	A	20
Operational current I_e	AC-1 ($\leq 40^\circ\text{C}$)	A 20
	AC-1 ($\leq 55^\circ\text{C}$)	A 18
	AC-1 ($\leq 70^\circ\text{C}$)	A 15
	AC-3 ($\leq 440\text{V} \leq 55^\circ\text{C}$)	A 9
	AC-4 (400V)	A 4
Rated operational power AC-3 ($T \leq 55^\circ\text{C}$)	230V	kW 2.2
	400V	kW 4
	415V	kW 4.3
	440V	kW 4.5
	500V	kW 5
	690V	kW 5
Rated operational power AC-1 ($T \leq 40^\circ\text{C}$)	230V	kW 8
	400V	kW 14
	500V	kW 16
	690V	kW 22
IEC max current I_e in DC1 with $L/R \leq 1\text{ms}$ with 1 poles in series	$\leq 24\text{V}$	A 12
	48V	A 10
	75V	A 4
	110V	A 3
	220V	A –
IEC max current I_e in DC1 with $L/R \leq 1\text{ms}$ with 2 poles in series	$\leq 24\text{V}$	A 15
	48V	A 14
	75V	A 9
	110V	A 8
	220V	A –
IEC max current I_e in DC1 with $L/R \leq 1\text{ms}$ with 3 poles in series	$\leq 24\text{V}$	A 16
	48V	A 16
	75V	A 10
	110V	A 10
	220V	A 2
IEC max current I_e in DC1 with $L/R \leq 1\text{ms}$ with 4 poles in series	$\leq 24\text{V}$	A 16
	48V	A 16
	75V	A 10
	110V	A 10

	≤24V	A	16
	48V	A	16
	75V	A	10
	110V	A	10
	220V	A	2
<hr/>			
IEC max current I _e in DC3-DC5 with L/R ≤ 15ms with 1 poles in series	≤24V	A	7
	48V	A	6
	75V	A	2
	110V	A	1
	220V	A	–
<hr/>			
IEC max current I _e in DC3-DC5 with L/R ≤ 15ms with 2 poles in series	≤24V	A	8
	48V	A	8
	75V	A	5
	110V	A	4
	220V	A	–
<hr/>			
IEC max current I _e in DC3-DC5 with L/R ≤ 15ms with 3 poles in series	≤24V	A	10
	48V	A	10
	75V	A	6
	110V	A	5
	220V	A	0,8
<hr/>			
IEC max current I _e in DC3-DC5 with L/R ≤ 15ms with 4 poles in series	≤24V	A	10
	48V	A	10
	75V	A	6
	110V	A	5
	220V	A	0,8
<hr/>			
Short-time allowable current for 10s (IEC/EN60947-1)		A	96
<hr/>			
Protection fuse	gG (IEC)	A	20
	aM (IEC)	A	10
<hr/>			
Making capacity (RMS value)		A	92
<hr/>			
Breaking capacity at voltage	440V	A	72
	500V	A	72
	690V	A	72
<hr/>			
Resistance per pole (average value)		mΩ	10
<hr/>			
Power dissipation per pole (average value)	I _{th}	W	4
	AC-3	W	0.81
<hr/>			
Tightening torque for terminals	min	Nm	0.8
	max	Nm	1
	min	I _{bin}	9
	max	I _{bin}	9
<hr/>			
Tightening torque for coil terminal	min	Nm	0.8
	max	Nm	1
	min	I _{bin}	9
	max	I _{bin}	9
<hr/>			
Max number of wires simultaneously connectable		Nr.	2

Conductor section			
AWG/Kcmil		max	12
Flexible w/o lug conductor section			
		min	mm ² 0.75
		max	mm ² 2.5
Flexible c/w lug conductor section			
		min	mm ² 1.5
		max	mm ² 2.5
Flexible with insulated spade lug conductor section			
		min	mm ² 1.5
		max	mm ² 2.5
Power terminal protection according to IEC/EN 60529			IP20 when properly wired
Mechanical features			
Operating position			
	normal allowable		Vertical plan ±30°
Fixing			Screw / DIN rail 35mm
Weight		g	177
Auxiliary contact characteristics			
Thermal current I _{th}		A	10
IEC/EN 60947-5-1 designation			A600 - Q600
Operating current AC15			
	230V	A	3
	400V	A	1.9
	500V	A	1.4
Operating current DC12			
	110V	A	2.9
Operating current DC13			
	24V	A	2.9
	48V	A	1.4
	60V	A	1.2
	110V	A	0.6
	125V	A	0.55
	220V	A	0.3
	600V	A	0.1
Operations			
Mechanical life		cycles	20000000
Electrical life		cycles	500000
Safety related data			
Performance level B10d according to EN/ISO 13489-1			
	rated load	cycles	500000
	mechanical load	cycles	20000000
EMC compatibility			yes
AC coil operating			
Rated AC voltage at 60Hz		V	48
AC operating voltage			
	of 60Hz coil powered at 60Hz		
	pick-up		
	min	%Us	75
	max	%Us	115
	drop-out		

	min	%Us	20
	max	%Us	55
AC average coil consumption at 20°C			
of 50/60Hz coil powered at 50Hz			
	in-rush	VA	30
	holding	VA	4
of 50/60Hz coil powered at 60Hz			
	in-rush	VA	25
	holding	VA	3
of 60Hz coil powered at 60Hz			
	in-rush	VA	30
	holding	VA	4
Dissipation at holding ≤20°C 50Hz		W	0.95
Max cycles frequency			
Mechanical operation		cycles/h	3600
Operating times			
Average time for Us control			
in AC			
Closing NO			
	min	ms	12
	max	ms	21
Opening NO			
	min	ms	9
	max	ms	18
Closing NC			
	min	ms	17
	max	ms	26
Opening NC			
	min	ms	7
	max	ms	17
in DC			
Closing NO			
	min	ms	18
	max	ms	25
Opening NO			
	min	ms	2
	max	ms	3
Closing NC			
	min	ms	3
	max	ms	5
Opening NC			
	min	ms	11
	max	ms	17
UL technical data			
Rated operational voltage AC (UL)		V	600
Full-load current (FLA) for three-phase AC motor			
	at 480V	A	7.6
	at 600V	A	6.1
Yielded mechanical performance			
for single-phase AC motor			
	110/120V	HP	0.5
	230V	HP	1.5
for three-phase AC motor			
	200/208V	HP	2

220/240V	HP	3
460/480V	HP	5
575/600V	HP	5

General USE

Contactor	AC current	A	20
Short-circuit protection fuse, 600V High fault	Short circuit current	kA	100
	Fuse rating	A	30
	Fuse class		J
Standard fault	Short circuit current	kA	5
	Fuse rating	A	30
	Fuse class		RK5
Contact rating of auxiliary contacts according to UL			A600 - Q600

Ambient conditions

Temperature

Operating temperature

min	°C	-50
max	°C	+70

Storage temperature

min	°C	-60
max	°C	+80

Max altitude

m 3000

Resistance & Protection

Pollution degree

3

Dimensions

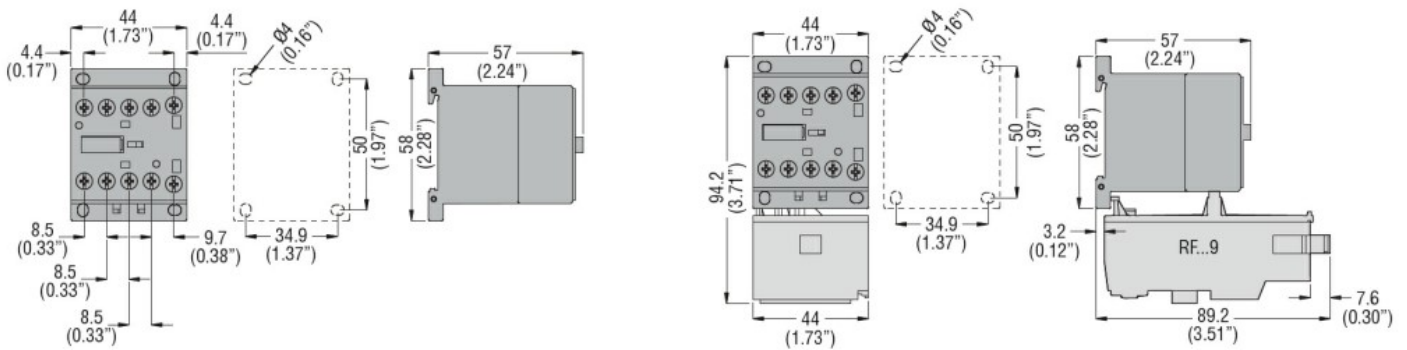

Wiring diagrams

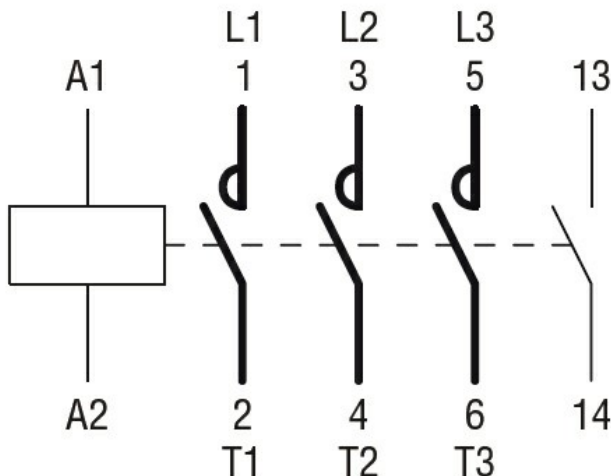

Certifications and compliance

Compliance

CSA C22.2 n° 60947-1

CSA C22.2 n° 60947-4-1

IEC/EN 60335-2-89

IEC/EN 60947-1

IEC/EN 60947-4-1

UL 60947-1

UL 60947-4-1

Certificates

CCC

CSA C22.2 n. 60335-2-40:22 LZGH A2L

CSA C22.2 No. 60335-2-89:21 LZGH A2L

cULus

EAC

UL 60335-2-40 LZGH A2L

UL 60335-2-89 LZGH A2L

ETIM classification

ETIM 8.0

EC000066 -
Power contactor,
AC switching