



### Contact characteristics

IEC Conventional free air thermal current $I_{th} \leq 40^\circ\text{C}$	A	200
Rated insulation voltage $U_i$ IEC/EN	V	1500
Operating current $I_e$		
DC21B		
	600V	A 200
	800V	A 200
	1000V	A 200
	1200V	A 200
	1500V	A 200
DCPV1		
	600V	A 200
	800V	A 200
	1200V	A 200
	1500V	A 200

### Mechanical features

Operating position	normal allowable	Vertical plan Any
Fixing		Screw / DIN rail 35mm
Terminals	type	M8 x 25
Tightening torque for terminals	min	Nm 15
	max	Nm 22
	min	lbin 132
	max	lbin 194
Conductor section	IEC min	mm <sup>2</sup> 70
	IEC max	mm <sup>2</sup> 185
	AWG/kcmil min	00
	AWG/kcmil max	kcmil 400

### Ambient conditions

Operating temperature	min	°C -25
	max	°C +55
Storage temperature	min	°C -40
	max	°C +70
Max altitude	m	3000

### Resistance & Protection

Pollution degree	3
------------------	---

### Dimensions

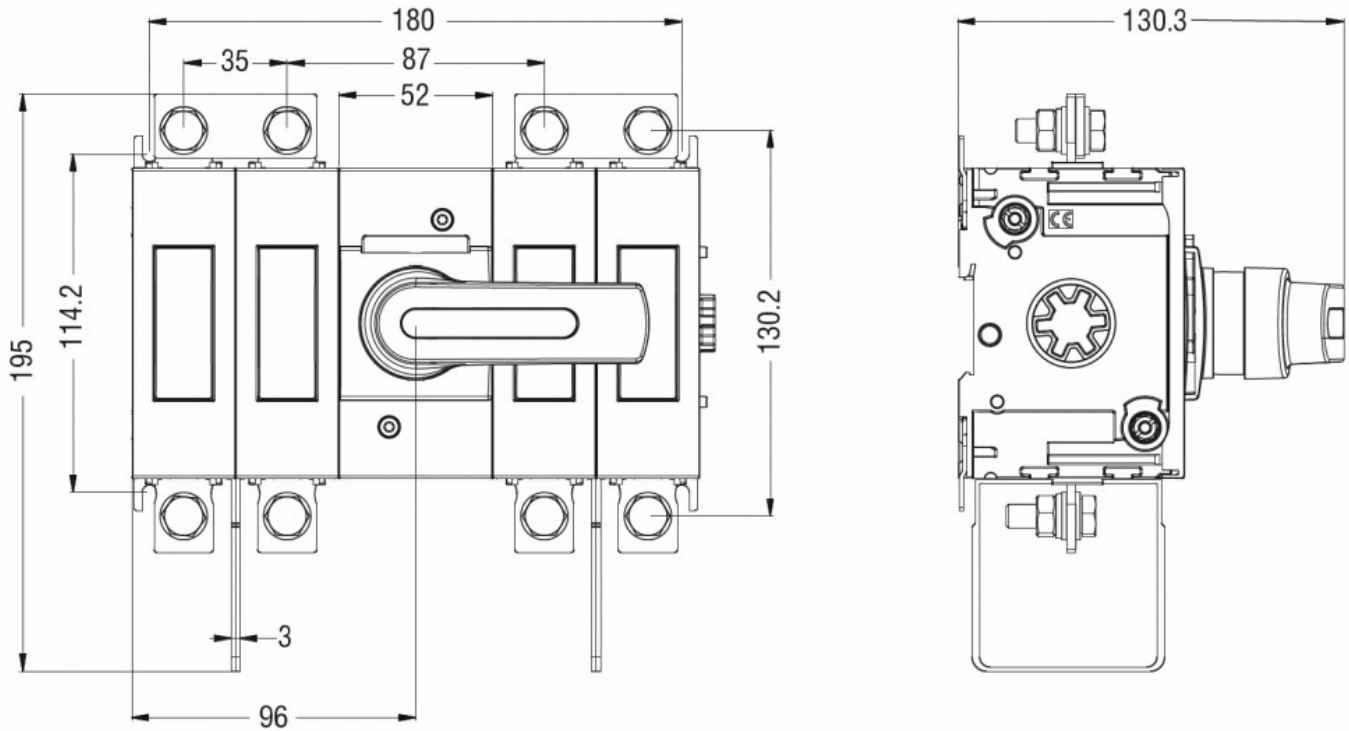

### Wiring diagrams

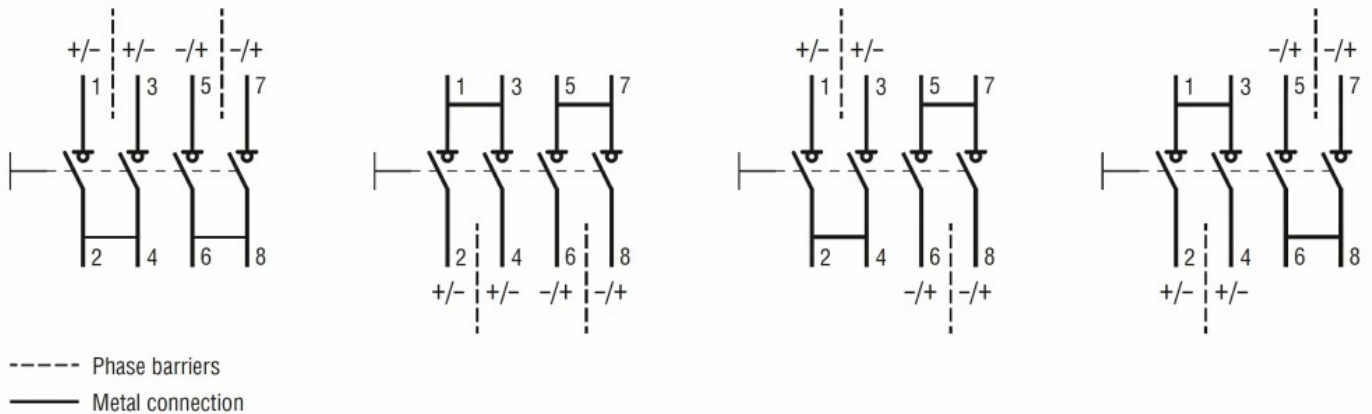

### Certifications and compliance

#### Compliance

IEC/EN/BS 60947-1

IEC/EN/BS 60947-3

#### Certifications

CE

### ETIM classification

ETIM 8.0

EC000216 -  
Switch  
disconnecter