



Contact characteristics

Number of poles	Nr.	4
Rated insulation voltage U_i IEC/EN	V	690
Rated impulse withstand voltage U_{imp}	kV	6
Operational frequency	min	Hz 25
	max	Hz 400
IEC Conventional free air thermal current $I_{th} \leq 40^\circ\text{C}$	A	10
Operational current I_e	AC-1 ($\leq 55^\circ\text{C}$)	A 0
	gG (IEC)	A 25
Tightening torque for terminals	min	Nm 1.5
	max	Nm 1.8
	min	lbin 1.1
	max	lbin 1.5
Tightening torque for coil terminal	min	Nm 0.8
	max	Nm 1
	min	lbin 0.8
	max	lbin 0.74
Max number of wires simultaneously connectable	Nr.	2
Conductor section	AWG/Kcmil	
	max	10
Flexible w/o lug conductor section	min	mm ² 1
	max	mm ² 6
Flexible c/w lug conductor section	min	mm ² 1
	max	mm ² 4
Flexible with insulated spade lug conductor section	min	mm ² 1
	max	mm ² 4
Power terminal protection according to IEC/EN 60529		IP20 when properly wired

Mechanical features

Operating position	normal allowable	Vertical plan $\pm 30^\circ$
		Screw / DIN rail 35mm
Fixing		
Weight	g	495

Auxiliary contact characteristics

Thermal current I _{th}		A	10
IEC/EN 60947-5-1 designation			A600 - P600
Operating current AC15	230V	A	3
	400V	A	1.9
	500V	A	1.4
Operating current DC12	110V	A	5.7
Operating current DC13	24V	A	5.7
	48V	A	2.9
	60V	A	2.3
	110V	A	1.25
	125V	A	1.1
	220V	A	0.55
	600V	A	0.2

Operations

Mechanical life cycles 20000000

Safety related data

Performance level B10d according to EN/ISO 13489-1

mechanical load cycles 20000000

EMC compatibility yes

DC coil operating

DC rated control voltage V 110

DC operating voltage

pick-up

min	%Us	70
max	%Us	125

drop-out

min	%Us	10
max	%Us	40

Average coil consumption ≤20°C

in-rush	W	5.4
holding	W	5.4

Max cycles frequency

Mechanical operation cycles/h 3600

Operating times

Average time for U_s control

in DC

Closing NO

min	ms	54
max	ms	66

Opening NO

min	ms	14
max	ms	17

Closing NC

min	ms	24
max	ms	30

Opening NC

min	ms	47
max	ms	57

UL technical data

Rated operational voltage AC (UL) V 600

General USE

Auxiliary contacts

AC current A 10

Contact rating of auxiliary contacts according to UL

A600 - P600

Ambient conditions

Temperature

Operating temperature

min °C -50
max °C 70

Storage temperature

min °C -60
max °C 80

Max altitude

m 3000

Resistance & Protection

Pollution degree

3

Dimensions

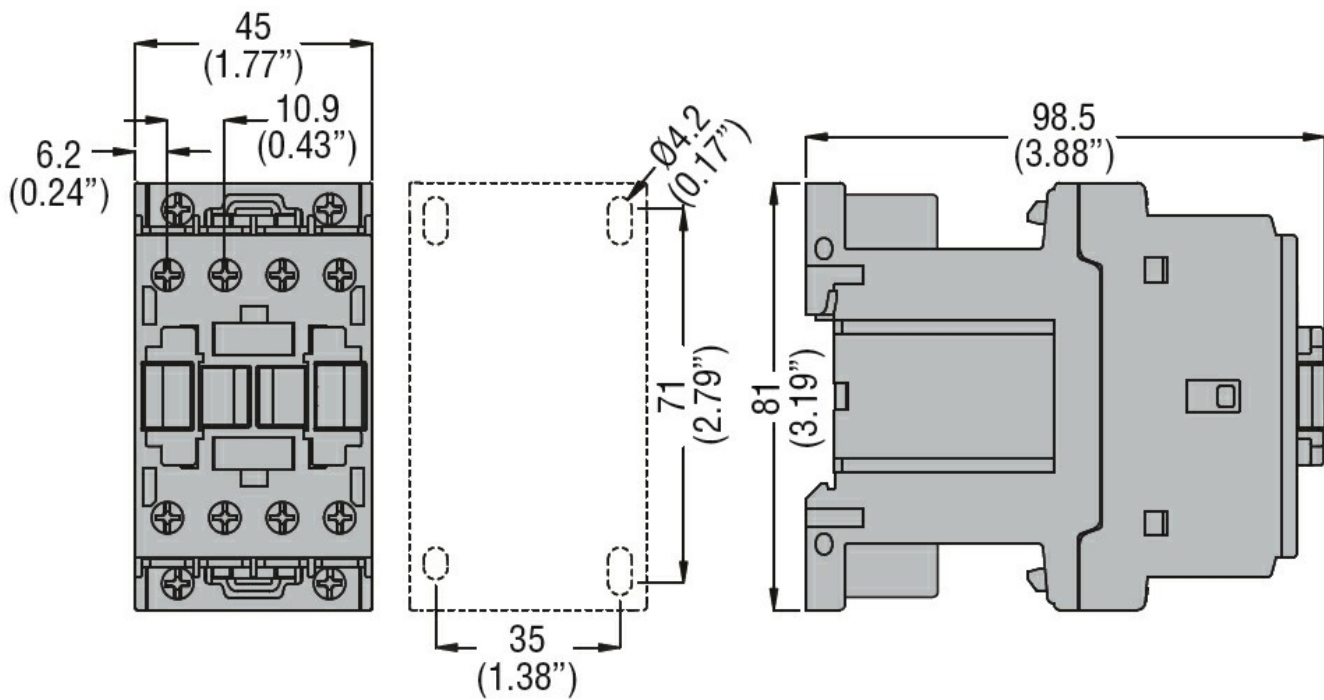

Wiring diagrams

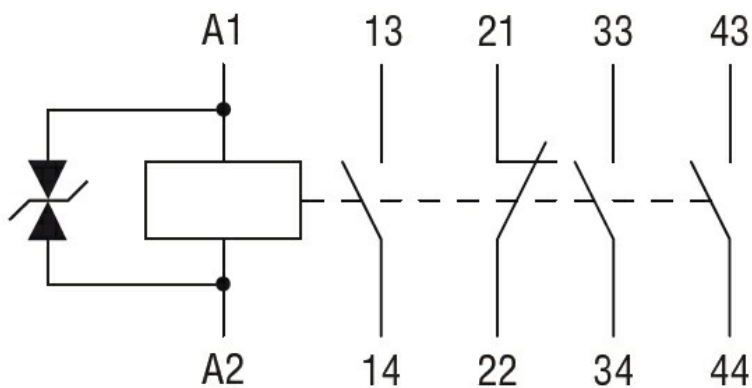

Certifications and compliance

Compliance

CSA C22.2 n° 60947-1
CSA C22.2 n° 60947-5-1

IEC/EN 60947-1
IEC/EN 60947-5-1
UL 60947-1
UL 60947-5-1

Certificates

CCC
cULus
EAC

ETIM classification

ETIM 8.0

EC000196 -
Contactor relay