

DALI RGBW LED Dimmer CV

Datasheet Control Gear

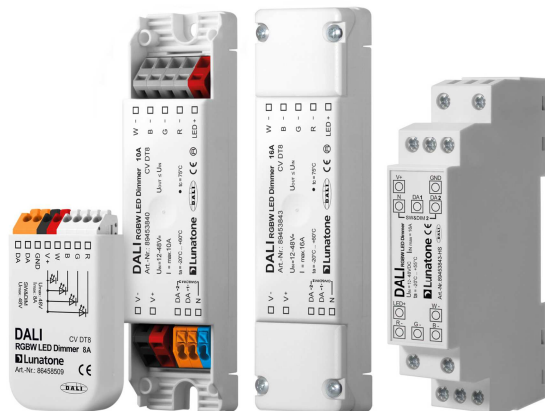

RGBW LED Dimmer (CV, DT8)

Art. Nr. **86458509 (8A)**

Art. Nr. 89453840 (10A)

Art. Nr. 89453843 (16A)

Art. Nr. 89453843-HS (16A, dinrail)

DALI RGBW LED Dimmer CV Control Gear

Overview

- DALI LED-Dimmer for RGBW colour control
- suitable for constant voltage LED-modules with operating voltages from 12V to 48V
- **Operating Mode DT8:** one DALI-address for the independent control of light level and colour (DALI DT8, Type RGBWAF)
- **Operating Mode Colour&Dim:** control by 2 DALI-addresses, one for adjusting the light level and one for adjusting the colour
- **SwitchDim2:** 2 switch-inputs offer control of light level and colour without DALI
- dimming range 0.1%-100%
- adjustable PWM-frequency (122Hz/244Hz/488Hz/976Hz)
- compact types for integration in luminaires, remote ceiling or dinrail mounting
- supply voltage 12V to 48V DC (according to the operating voltage of the led modules)
- type dependent max. input currents of 4A, 8A, 10A or 16A
- the maximum input current can be distributed on the channels at will
- low standby power consumption
- high efficiency
- configuration via PC-software DALI-Cockpit and DALI USB-interface
- user-friendly factory default settings

Specification, Characteristics

type	DALI RGBW LED Dimmer CV			
article number	86458509	89453840	89453843	89453843-HS
electrical data:				
supply voltage	12VDC-48VDC			
maximum input current linmax	8A	10A	16A	
control input	DALI	DALI SwitchDim2 (mains voltage)		
current consumption DALI	2mA			
number of DALI-addresses	operating mode DT8: 1 operating mode Colour&Dim: 2			
standby power consumption (12V)	~ 120mW			
technical data:				
power on behaviour	configurable: 0%-100% or last value			
storage/transportation temperature	-20°C ... +75°C			
operational ambient temperature	-20°C ... +60°C			
expected lifetime (at Tc<=75°C)	>100000h			
protection class	IP20			
max. connecting wire cross section	1.5 mm ²	2.5 mm ² / DALI&SwDim: 1.5 mm ²		2.5 mm ²
dimensions (LxWxH)	59x33x15 mm	120x30x22 mm		98x17x56 mm
housing/mounting	back box	remote ceiling		dinrail

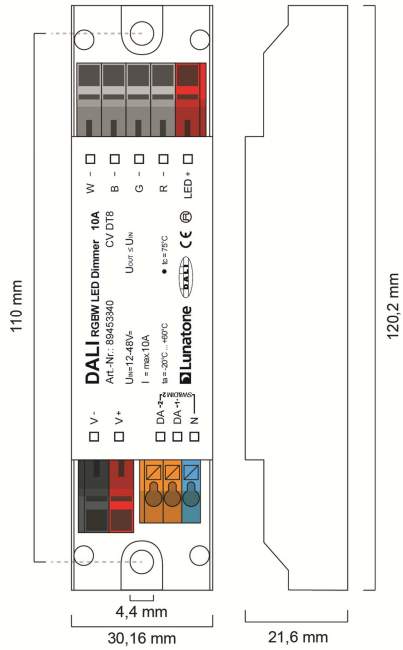

dimensions remote ceiling

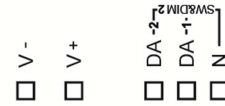
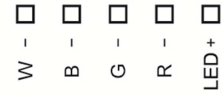

connection plan remote ceiling

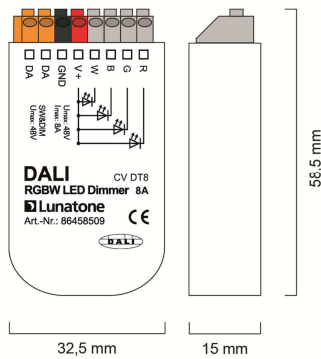

dimensions back box

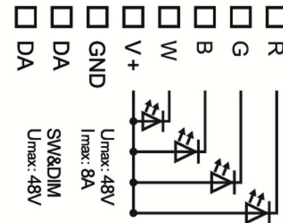

connection plan back box

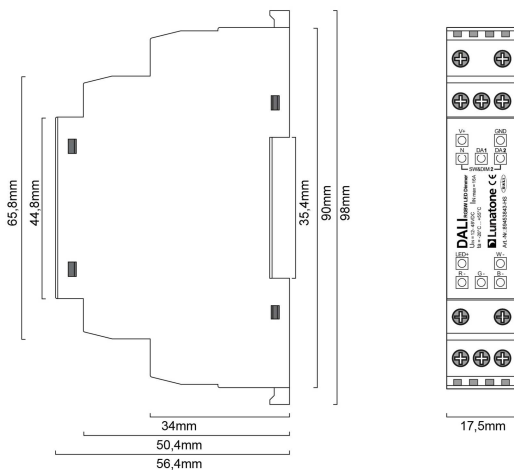

Geometrie Hutschiene

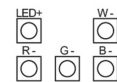
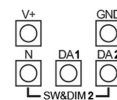

Anschlussplan Hutschiene

RECOMMENDATION: Care should be taken on keeping cable lengths between DC power supply and dimmer as well as between dimmer and luminaires (Led-Strings) as short as possible. This kind of installation will minimize the influence of voltage drops.

DALI:

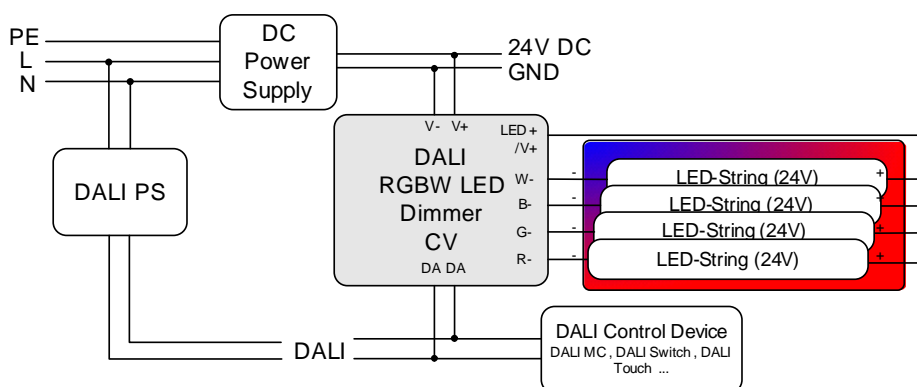

SwitchDim2:

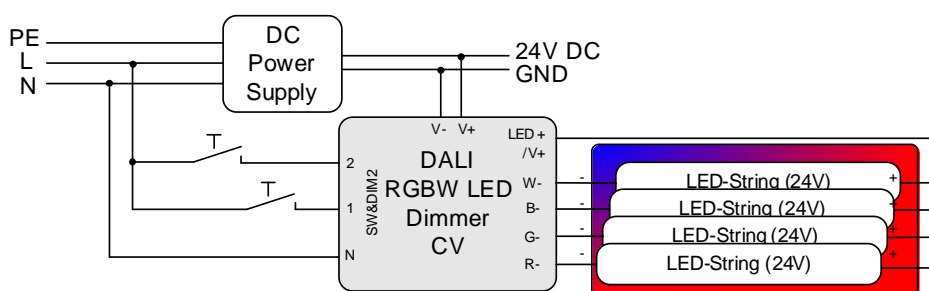

Operating Modes

The device offers several operating modes:

DT8 (factory default)

In this operating mode one DALI-address for the independent control of light level and colour is used (Device Type 8 RGBWAF).

Alternatively the device can be controlled using 2 switch-inputs for mains voltage (SwitchDim2):

SwD1: light level

short press: On/Off

long press: dimming

SwD2: colour

long press: change colour

Colour&Dim

This operating mode is suitable for operating RGB—luminaires. Two DALI-addresses are

used, the first to control the light level and the second for changing the distribution on the output channels (e.g. for colour adjustments).

The Colour&Dim mode allows colour adjustments without affecting the level and vice versa. For each channel only DALI-standard commands like dim up/down but also DAP are used. Thus the device can be used with all common controls and gateways (e.g. KNX). The Colour&Dim mode provides an alternative to the DT8-RGBWAF mode.

Can be operated via DALI or SwitchDim2:

DALI-address 1, SwD1: light level

DALI-address 2, SwD2: colour

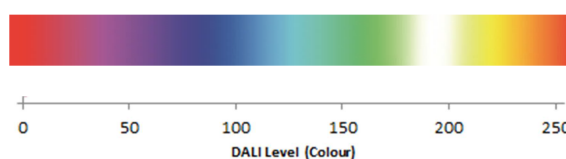

Selection of operating mode

With the help of the PC-software tool DALI-Cockpit the operating mode can be easily set on the general settings page.

Operating mode DT8-RGBWAF:

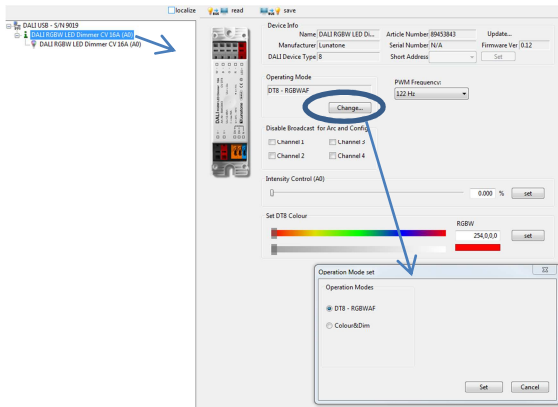

In addition, on the same page the PWM-frequency can be selected and basic control elements for testing each operating modes are available (slider for level and colour in the operating modes DT8 and Colour&Dim). Furthermore the broadcast control can be deactivated for each channel individually.

Operating mode Colour&Dim:

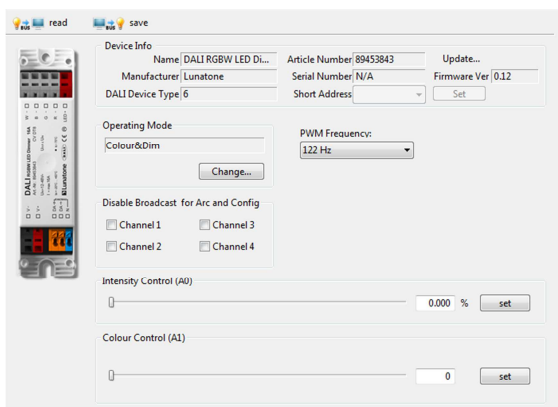

Switching between operating modes can also be done with the help of the DALI-command SET OPERATING MODE (IEC 62386-102 Ed.2). When changing the operating mode the number of used DALI-addresses can change as well and this requires a new addressing procedure. In the DALI-Cockpit this address assignment is performed automatically.

Operating Mode:

number	operating mode
0x0	DT8 (factory default)
0x92	DT8
0x93	Colour&Dim

Additional Settings

Besides the settings on the general page each channel can be selected separately in the component tree for individual configuration.

Component Tree:

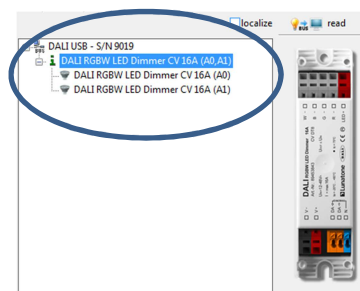

Settings in the operating mode DT8-RGBWAF (displayed parameters are the factory default values)

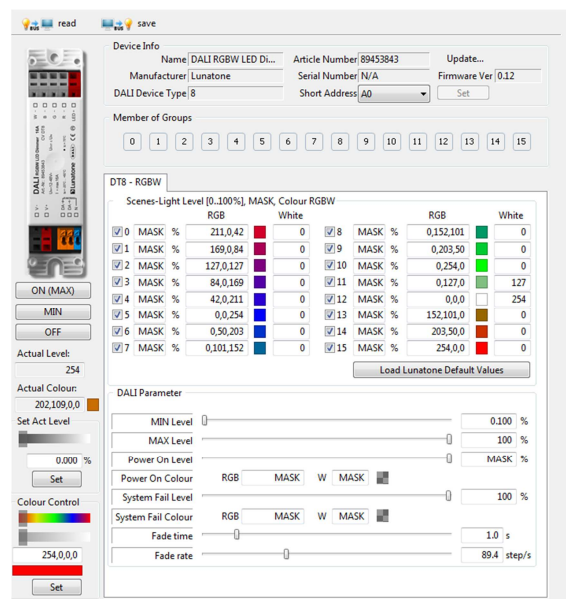

Settings for each channel in the operating mode Colour&Dim:

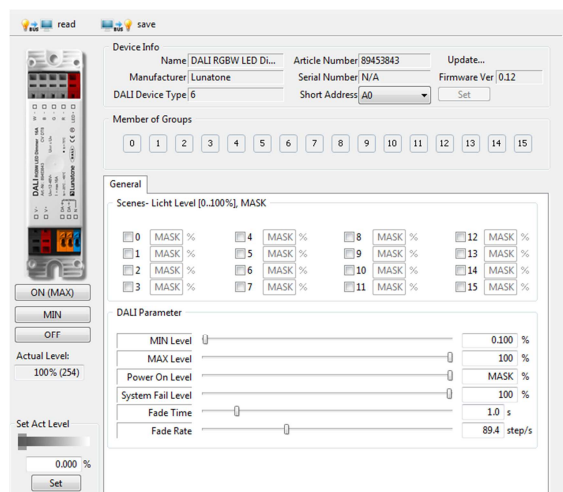

For each address the group membership can be set as well as scene values and DALI-parameters. In Colour&Dim operating mode, all values assigned to channel 2 are representing colours.

Factory Default Settings

Before the initial addressing is performed, the device can already be controlled by a group address. This predefined grouping will be deleted during the first addressing procedure. Afterwards groups can be assigned as usual (e.g. with the help of the DALI Cockpit). By sending a DALI-Reset command the device is set to the DALI default values as defined in the standard.

Summary of the factory default settings (delivery state):

Operating mode	DT8
SwitchDim2	SwD1: level SwD2: colour
Min Level	0.1%
PowerOn Level	MASK (last value)
Fade Time	2 (1s)
Fade Rate	5 (89.4 steps/s)
PWM-frequency	122Hz
Groups before initial	G0 (or G0 and G1 in operating)

addressing: mode Colour&Dim)

Predefined Scene Values:

			RGB	White
<input checked="" type="checkbox"/>	0	MASK	% 211,0,42	0
<input checked="" type="checkbox"/>	1	MASK	% 169,0,84	0
<input checked="" type="checkbox"/>	2	MASK	% 127,0,127	0
<input checked="" type="checkbox"/>	3	MASK	% 84,0,169	0
<input checked="" type="checkbox"/>	4	MASK	% 42,0,211	0
<input checked="" type="checkbox"/>	5	MASK	% 0,0,254	0
<input checked="" type="checkbox"/>	6	MASK	% 0,50,203	0
<input checked="" type="checkbox"/>	7	MASK	% 0,101,152	0
<input checked="" type="checkbox"/>	8	MASK	% 0,152,101	0
<input checked="" type="checkbox"/>	9	MASK	% 0,203,50	0
<input checked="" type="checkbox"/>	10	MASK	% 0,254,0	0
<input checked="" type="checkbox"/>	11	MASK	% 0,127,0	127
<input checked="" type="checkbox"/>	12	MASK	% 0,0,0	254
<input checked="" type="checkbox"/>	13	MASK	% 152,101,0	0
<input checked="" type="checkbox"/>	14	MASK	% 203,50,0	0
<input checked="" type="checkbox"/>	15	MASK	% 254,0,0	0

Purchase Order Information

Art.Nr. 86458509: RGBW LED Dimmer, CV, input current 8A, 12V-48V DC, back box

Art.Nr. 89453840: RGBW LED Dimmer, CV, input current 10A, 12V-48V DC, SwitchDim2, remote ceiling & integration in luminaires

Art.Nr. 89453843: RGBW LED Dimmer, CV, input current 16A, 12V-48V DC, SwitchDim2, remote ceiling & integration in luminaires

Art.Nr. 89453843-HS: RGBW LED Dimmer, CV, input current 16A, 12V-48V DC, SwitchDim2, din rail mounting

Additional Information and Equipment

DALI-Cockpit – free configuration tool from Lunatone for DALI systems

<http://lunatone.at/en/downloads/Lunatone-DALI-Cockpit.zip>

Lunatone DALI products

<http://www.lunatone.at/en/>

Lunatone datasheets and manuals

<http://lunatone.at/en/downloads/>

Contact

Technical Support: support@lunatone.com

Requests: sales@lunatone.com

www.lunatone.com

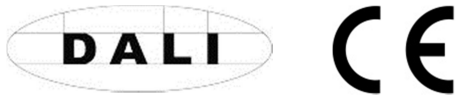

Disclaimer

Subject to change. Information provided without guarantee.
The datasheet refers to the current delivery.

The compatibility with other devices must be tested in advance
to the installation.