

Sistemi  
TR4114-4

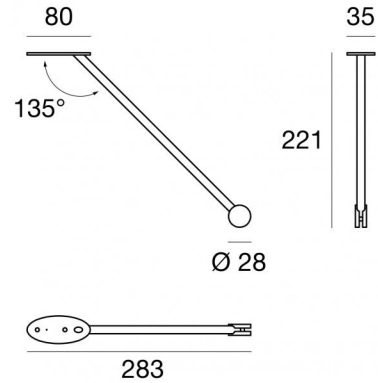

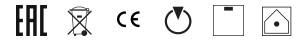







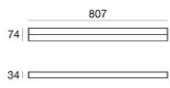

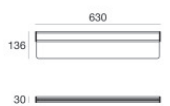

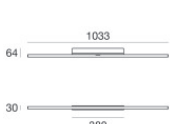

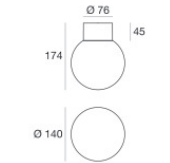
Dati tecnici	
Tipologia	Mono System
Posizione installativa	Soffitto
Ambiente installativo	Indoor
Lampadina inclusa	No
Prova del filo incandescente	850°
Montaggio diretto su superfici normalmente infiammabili	Si
CE	Si
Articolo dimmerabile	No
Orientabilità	No
Basculante	No
Calpestabilità	No
Carrabilità	No
Cavo incluso	No
Resinatura	No
Peso netto	0.26 Kg

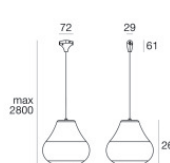
Finitura Finitura corpo	
Materiale	Ferro
Colore	Bianco RAL 9010
Lavorazione	verniciatura

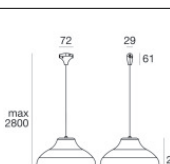

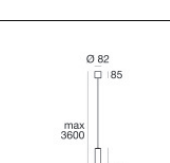

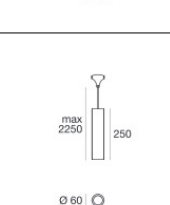





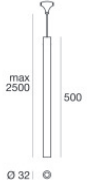

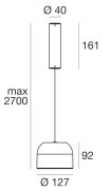

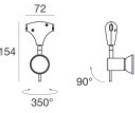
Sistemi  
**TR4114-4**

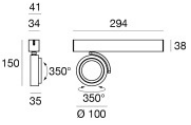
## Components

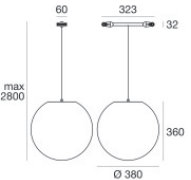
		Iota-C	<p><b>Code</b> 9860 - 9859 - 9857 - 9856 - 9855 - 9858 - 9855M - 9856M - 9855N - 9856N - 9857M - 9858M - 9857N - 9858N - 9859M - 9860M - 9859N - 9860N</p>
		Trix-C	<p><b>Code</b> <u>8430 - 8431 - 8429</u></p>
		Circular	<p><b>Code</b> <u>8445 - 8446 - 8447</u></p>
		Oh!-C1	<p><b>Code</b> <u>10115 - 10116</u></p>
		Sisters-C_248	<p><b>Code</b> <u>8653</u></p>
		Sisters-C_310	<p><b>Code</b> <u>8656</u></p>
		Tu-V-C	<p><b>Code</b> <u>8650</u></p>
		Baton-C_1	<p><b>Code</b> <u>64652 - 64653</u></p>

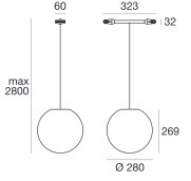
Sistemi  
TR4114-4

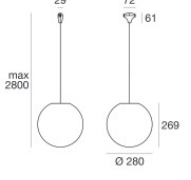
## Components

		Baton-C_2	<b>Code</b> <u>64656 - 64657</u>
		Outlook-C	<b>Code</b> <u>8422</u>
		Andromeda-C_1	<b>Code</b> <u>TR4304-4R - TR4304-5 - TR4304-6</u>
		Eta-C	<b>Code</b> <u>9869 - 9868 - 9867 - 9871 - 9870 - 9872 - 9867M - 9870M - 9868M - 9871M - 9869M - 9872M - 9867N - 9870N - 9868N - 9871N - 9869N - 9872N</u>
		Oh!-C30_380	<b>Code</b> <u>12145</u>
		Oh!-C30_280	<b>Code</b> <u>12142</u>
		Oh!-C2_280	<b>Code</b> <u>12140</u>
		Orion-C_1	<b>Code</b> <u>59754</u>

Sistemi  
TR4114-4

## Components

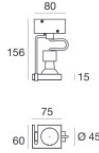

Orion-C\_2

Code  
59744