

Sistemi | 220-240 V | 1xE27

TR4014-5

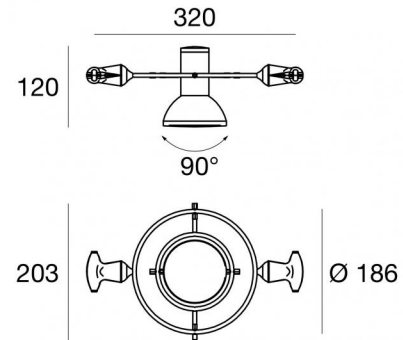

| Dati tecnici  |             |
|---|-------------|
| Tipologia   | Sistemi     |
| Posizione installativa                                  | Soffitto    |
| Ambiente installativo                                   | Indoor      |
| Lampadina inclusa                                       | No          |
| Attacco della lampadina                                 | 1 x E27     |
| Frequenza   | 50-60 Hz    |
| Ottica  | Diffused    |
| Classe di isolamento                                    | 2           |
| IP  | IP20        |
| Prova del filo incandescente                            | 850°        |
| Montaggio diretto su superfici normalmente infiammabili | Si          |
| CE  | Si          |
| Articolo dimmerabile                                    | No          |
| Orientabilità   | Orientabile |
| angolo totale (piano verticale)                         | 90 °        |
| angolo totale (piano orizzontale)                       | 90 °        |
| Basculante  | No          |
| Calpestabilità  | No          |
| Carrabilità   | No          |
| Cavo incluso  | No          |
| Resinatura  | No          |
| Peso netto  | 0.54 Kg     |

| Finitura Finitura corpo |                               |
|-------------------------|-------------------------------|
| Materiale               | Ferro - Ferro - policarbonato |
| Colore                  | Polished (galvanic) chrome    |
| Lavorazione             | galvanostegia                 |

Sistemi | 220-240 V | 1xE27  
**TR4014-5**

Sistemi a singola emissione per applicazione indoor. Compatibile con: lampadina LED;  
attacco 1xE27.

Il corpo dell'apparecchio, realizzato in ferro, presenta una finitura di colore polished (galvanic) chrome, ottenuta tramite galvanostegia. Il corpo dell'apparecchio, realizzato in ferro, presenta una finitura di colore grigio metallizzato. Il corpo dell'apparecchio, realizzato in policarbonato, presenta una finitura di colore grigio metallizzato.

Il grado di protezione è IP20; il peso complessivo è di 0.54 kg.

L'apparecchio presenta una classe di isolamento II ed è installabile a soffitto.

Conforme alla norma EN 60598-1 e alle relative prescrizioni particolari.

Sistemi | 220-240 V | 1xE27

TR4014-5







## Components

|  |  |   |  |
|--|--|---|--|
|  |  | <p>300 System Accessories - Sistemi</p>               | <p><b>Code</b><br/><u>TR4101-4</u></p> |
|  |  | <p>300 System Accessories - Sistemi</p>               | <p><b>Code</b><br/><u>TR4101-5</u></p> |
|  |  | <p>300 System Accessories - Sistemi</p>               | <p><b>Code</b><br/><u>TR4103-4</u></p> |
|  |  | <p>300 System Accessories - Sistemi</p>               | <p><b>Code</b><br/><u>TR4103-5</u></p> |
|  |  | <p>300 System Accessories</p>                         | <p><b>Code</b><br/><u>TR4104-3</u></p> |
|  |  | <p>300 System Accessories - 1.5m - Grey - Sistemi</p> | <p><b>Code</b><br/><u>TR4105-5</u></p> |
|  |  | <p>300 System Accessories</p>                         | <p><b>Code</b><br/><u>TR4109-4</u></p> |
|  |  | <p>300 System Accessories</p>                         | <p><b>Code</b><br/><u>TR4109-5</u></p> |

Sistemi | 220-240 V | 1xE27

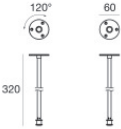
**TR4014-5**

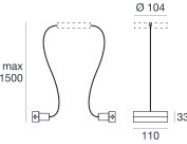

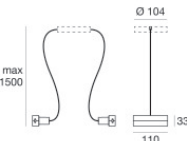





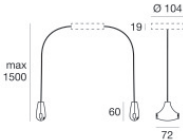

## Components

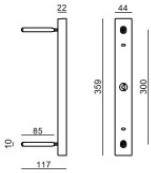
|   |   |   |                                 |
|---|---|---|---------------------------------|
|   |   | Supporting cable - 50m - Sistemi                | <b>Code</b><br><u>TR4151-50</u> |
|   |   | Supporting cable - 30m - Sistemi                | <b>Code</b><br><u>TR4151-30</u> |
|   |   | Supporting cable - 20m - Sistemi                | <b>Code</b><br><u>TR4151-20</u> |
|   |   | Supporting cable - 10m - Sistemi                | <b>Code</b><br><u>TR4151-10</u> |
|   |   | Supporting cable - 5m - Sistemi                 | <b>Code</b><br><u>TR4151-5</u>  |
|   |  | 300 System Accessories - 1.5m - White - Sistemi | <b>Code</b><br><u>TR4105-4R</u> |
|  |  | 300 System Accessories - Sistemi                | <b>Code</b><br><u>8721</u>      |
|  |  | 300 System Accessories - Sistemi                | <b>Code</b><br><u>8722</u>      |

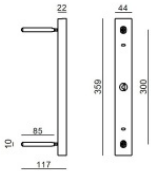
Sistemi | 220-240 V | 1xE27

TR4014-5

## Components

|  |  |   |   |
|--|--|---|---|
|   |   | <p>300 System Accessories - Sistemi</p>       | <p><b>Code</b><br/><u>8729</u></p>      |
|   |   | <p>300 System Accessories - Sistemi</p>       | <p><b>Code</b><br/><u>9873</u></p>      |
|  |  | <p>300 System Accessories</p>                 | <p><b>Code</b><br/><u>9874</u></p>      |
|  |  | <p>Supporting black cable - 5m</p>            | <p><b>Code</b><br/><u>TR4153-5</u></p>  |
|  |  | <p>Supporting black cable - 10m - Sistemi</p> | <p><b>Code</b><br/><u>TR4153-10</u></p> |
|  |  | <p>Supporting black cable - 20m - Sistemi</p> | <p><b>Code</b><br/><u>TR4153-20</u></p> |
|  |  | <p>Supporting black cable - 30m - Sistemi</p> | <p><b>Code</b><br/><u>TR4153-30</u></p> |
|  |  | <p>Supporting black cable - 50m - Sistemi</p> | <p><b>Code</b><br/><u>TR4153-50</u></p> |

Sistemi | 220-240 V | 1xE27

TR4014-5

## Components

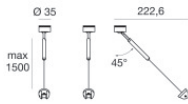

300 System Accessories - Sistemi

**Code**  
TR4124-4

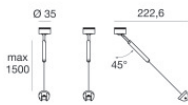

300 System Accessories - Sistemi

**Code**  
TR4124-5

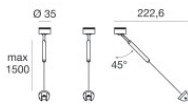

300 System Accessories - Sistemi

**Code**  
TR4124-6

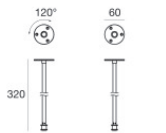

300 System Accessories - 1.5m - Grey - Sistemi

**Code**  
TR4105-6

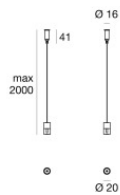

300 System Accessories - Sistemi

**Code**  
TR4103-6

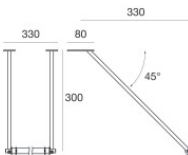

300 System Accessories - Sistemi

**Code**  
TR4101-6

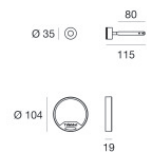

300 System Accessories - Sistemi

**Code**  
TR4109-6

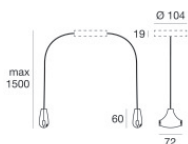

300 System Accessories - Sistemi

**Code**  
8730

Sistemi | 220-240 V | 1xE27

TR4014-5

## Components

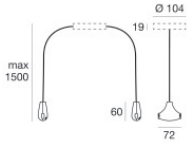

300 System Accessories - Sistemi

Code

8731