

LED Strip | 112 topLED 9.6 W DC 24 V | 9.6 W/m  
274 Lm/m | CRI >90  
C0017WDI01004

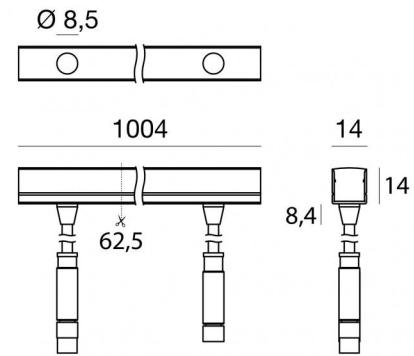

Dati tecnici	
Lunghezza	1000 mm
Taglio Minimo	62.5 mm
Tipologia	LED Strip
Posizione installativa	Parete - Soffitto
Ambiente installativo	Outdoor
Sorgente luminosa	Tecnologia LED
Struttura del circuito	topLED
Ottica	Diffused
Direzione emissione luminosa	verso il basso
Potenza nominale	9.6 W DC
Potenza / m	9.6 W / m
Flusso luminoso sorgente	274 lm
Flusso luminoso sorgente / m	274 lm / m
Range di tensione in ingresso	24V
CCT / Tonalità	3000 K
Indice di resa cromatica	>90 Ra
C.C. / C.V.	CV
Classe di isolamento	3
IP	IP67
IK	IK07
Prova del filo incandescente	650°
Montaggio diretto su superfici normalmente infiammabili	Si
CE	Si
ETL	Si
Driver incluso	No
Articolo dimmerabile	DALI - 1-10V
Orientabilità	No
Basculante	No
Calpestabilità	No
Carrabilità	No
Cavo incluso	Si
Lunghezza del cavo	1(M)x0.25 m + 1(F)x0.25
Resinatura	Si
Tipologia di emissione luminosa	Singola emissione
Peso netto	0.103 Kg
Protezione scariche elettrostatiche	No
Protezione surge	No

**Finitura Finitura corpo**

Materiale	Tecnopolimero
Colore	grigio

**Finitura Finitura diffusore**

Materiale	poliuretano
Colore	grigio

**Elettronica**

- 
99331  
On/Off Driver 198~264V AC / V DC (1 - 15 art.)
- 
99332  
1-10V Controller (1 - 15 art.)
- 
99374  
On/Off Driver 198~264V AC / V DC (1 - 7 art.)
- 
83333  
Push and Simply Dim - DALI-2 Controller (1 - 15 art.)
- 
C-E400002  
Push and Simply Dim - DALI-2 Controller (1 - 25 art.)

LED Strip | 112 topLED 9.6 W DC 24 V | 9.6 W/m | 274 Lm/m | CRI >90 | Base  
**C0017WDI01004**

Led strip a singola emissione per applicazione outdoor. La sorgente luminosa LED, di colore bianco caldo, con distribuzione luminosa Diffusa, è composta da 112 LED topLED, con una CCT 3000 K ed un CRI >90; il flusso luminoso della sorgente è di 274 lm, con un'efficienza nominale di 28.5 lm/W.

Il corpo dell'apparecchio, realizzato in tecnopolimero, presenta una finitura di colore grigio; il diffusore è prodotto in poliuretano.

Il grado di protezione è IP67; il peso complessivo è di 0.103 kg. Il driver d'alimentazione non è fornito e deve essere ordinato separatamente.

La potenza assorbita dall'apparecchio è di 9.6 W Il cavo per l'alimentazione è incluso e presenta una lunghezza di 1(M)x0.25 m + 1(F)x0.25 m.

L'apparecchio presenta una classe di isolamento III ed è installabile a parete o soffitto su muratura con controcassa cod. 82199.

Conforme alla norma EN 60598-1 e alle relative prescrizioni particolari.

### Classe di efficienza energetica

Questo prodotto contiene una sorgente luminosa di classe di efficienza energetica F.

### Caratteristiche Illuminotecniche

Resa luminosa apparecchio (LOR)	80 %
Flusso luminoso sorgente	274 lm
Flusso luminoso apparecchio	220 lm
Potenza reale apparecchio	9.5 W
Efficienza reale apparecchio	23 lm/W
Temperatura di colore	3000 K
Deviazione standard di corrispondenza colore	3 Step MacAdam
Indice di resa cromatica	>90 Ra
Temperatura standard dell'ambiente di esercizio	-20 / +55°C

### LED Life / Failure Ratio

L70 B20 C0 72500h

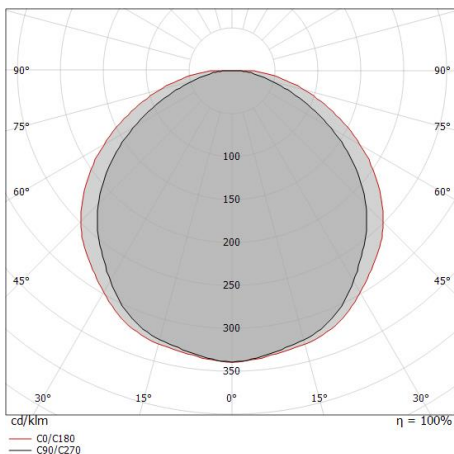

Distance [m]	Cone diameter [m]	illuminance [lx]	E(0°)	E(C90)	E(C0)
0.5	1.38 1.76	299 30 18	54.0°	60.4°	60.4°
1.0	2.75 3.52	75 8 5	54.0°	60.4°	60.4°
1.5	4.13 5.28	33 3 2	54.0°	60.4°	60.4°
2.0	5.51 7.04	19 2 1	54.0°	60.4°	60.4°
2.5	6.88 8.80	12 1 1	54.0°	60.4°	60.4°
3.0	8.26 10.56	8 1 1	54.0°	60.4°	60.4°

Distance [m]      Cone diameter [m]      illuminance [lx]

— C0/C180 (Half-peak divergence: 120.8°)  
 — C90/C270 (Half-peak divergence: 108.0°)

LED Strip | 112 topLED 9.6 W DC 24 V | 9.6 W/m | 274 Lm/m | CRI >90  
**C0017WDI01004**

## Components

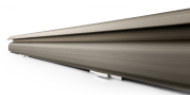

D-Wave

**Code**

77407

Rubber 3D concrete | LED Strip | Accessories  
**C0017WDI01004**

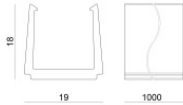

Controcassa - Profilo lineare in alluminio 19x18x1000mm per Rubber 3D, Rubber 3D Concrete, Rubber 3D 48V, Rubber 3D Optic, Rubber 3d Pixel  
 posizione installativa: parete, soffitto L=1000mm, H=18mm, D=19mm.  
 Materiale:alluminio, colore:alluminio, lavorazione:anodizzazione.

**Code**  
99549

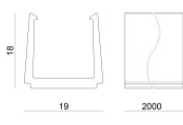
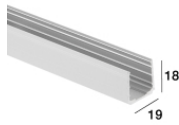

Controcassa - Profilo lineare in alluminio 19x18x2000mm per Rubber 3D, Rubber 3D Concrete, Rubber 3D 48V, Rubber 3D Optic, Rubber 3D Pixel  
 posizione installativa: parete, soffitto L=2000mm, H=18mm, D=19mm.  
 Materiale:alluminio, colore:alluminio, lavorazione:anodizzazione.

**Code**  
82198

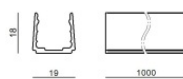

Profilo - Profilo 18x19 in alluminio nero 1m per Rubber 3D, Rubber 3D Concrete, Rubber 3D 48V, Rubber 3D Optic, Rubber 3D Pixel  
 Materiale:alluminio, colore:Black, lavorazione:anodizzazione.

**Code**  
C-K100007

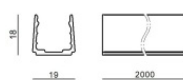

Profilo - Profilo 18x19 in alluminio nero 2m per Rubber 3D, Rubber 3D Concrete, Rubber 3D 48V, Rubber 3D Optic, Rubber 3D Pixel  
 Materiale:alluminio, colore:Black, lavorazione:anodizzazione.

**Code**  
C-K100008

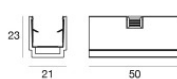

Staffa - Clip con molla dentata - Anodised Aluminium - per Rubber 3D (non per Rubber 3D PROtection)  
 posizione installativa: parete, soffitto L=50mm, H=23mm, D=21mm.  
 Materiale:alluminio, colore:alluminio, lavorazione:anodizzazione.

**Code**  
C-F400001

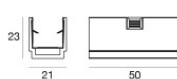

Staffa - Clip con molla dentata - Anodised Black Aluminium - per Rubber 3D (non per Rubber 3D PROtection)  
 posizione installativa: parete, soffitto L=50mm, H=23mm, D=21mm.  
 Materiale:alluminio, colore:Black, lavorazione:anodizzazione.

**Code**  
C-F400002

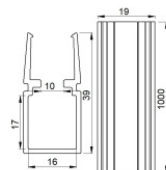

Controcassa - Profilo lineare con passaggio cavo in alluminio 39x18x1000mm per Rubber 3D, Rubber 3D Concrete, Rubber 3D 48V, Rubber 3D Optic, Rubber 3D Pixel  
 posizione installativa: parete, soffitto L=1000mm, H=39mm, D=19mm.  
 Materiale:alluminio, colore:alluminio, lavorazione:anodizzazione.

**Code**  
83034

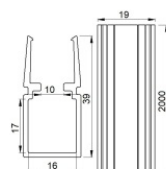

Controcassa - Profilo lineare con passaggio cavo in alluminio 39x18x2000mm per Rubber 3D, Rubber 3D Concrete, Rubber 3D 48V, Rubber 3D Optic, Rubber 3D Pixel  
 posizione installativa: parete, soffitto L=2000mm, H=39mm, D=19mm.  
 Materiale:alluminio, colore:alluminio, lavorazione:anodizzazione.

**Code**  
82199

Rubber 3D concrete | LED Strip | Accessories  
C0017WDI01004

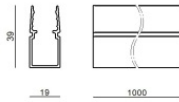

Profilo - Profilo 39x19 Alluminio nero 1m per Rubber 3D, Rubber 3D Concrete, Rubber 3D 48V, Rubber 3D Optic, Rubber 3D Pixel  
Materiale:alluminio, colore:Black, lavorazione:anodizzazione.

**Code**  
C-K100009

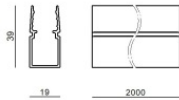

Profilo - Profilo 39x19 Alluminio nero 2m per Rubber 3D, Rubber 3D Concrete, Rubber 3D 48V, Rubber 3D Optic, Rubber 3D Pixel  
Materiale:alluminio, colore:Black, lavorazione:anodizzazione.

**Code**  
C-K100010

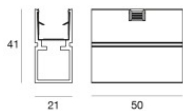

Staffa - Clip con molla dentata con passaggio cavo - Anodised Aluminium - per Rubber 3D (non per Rubber 3D PROtection)  
posizione installativa: parete, soffitto L=50mm, H=41mm, D=21mm.  
Materiale:alluminio, colore:alluminio, lavorazione:anodizzazione.

**Code**  
C-F400003

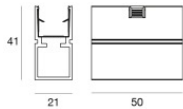

Staffa - Clip con molla dentata con passaggio cavo - Anodised Black Aluminium - per Rubber 3D (non per Rubber 3D PROtection)  
posizione installativa: parete, soffitto L=50mm, H=41mm, D=21mm.  
Materiale:alluminio, colore:Black, lavorazione:anodizzazione.

**Code**  
C-F400004



Profilo - Profilo flessibile  
Materiale:Acciaio AISI 304, colore:acciaio.

**Code**  
C-K100011

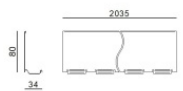
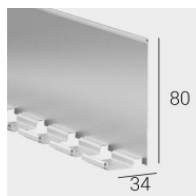

Antiabbagliamento - Palpebra anti-abbagliamento a spina di pesce  
Tipo Antiabbagliamento: palpebra.  
Materiale:Alluminio 6060, colore:Anodised aluminium, lavorazione:Anodizzazione 20 µm.

**Code**  
C-K100032

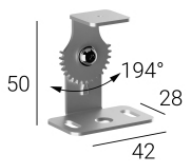

Kit di fissaggio - Kit basculazione a muro in acciaio AISI304  
Materiale:Acciaio AISI 304, colore:acciaio.

**Code**  
C-K400168

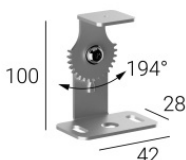

Kit di fissaggio - Kit basculazione a muro in acciaio AISI304  
Materiale:Acciaio AISI 304, colore:acciaio.

**Code**  
C-K400169

Rubber 3D concrete | LED Strip | Accessories

C0017WDI01004

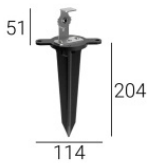

Picchetto - PICCHETTO PER RUBBER + STAFFA PICCHETTO PER RUBBER + STAFFA  
PICCHETTO+STAFFA D114X204 per Rubber 3D, Rubber 3D Concrete, Rubber 3D 48V, Rubber  
3D Optic, Rubber 3D Pixel  
posizione installativa: terreno, Materiale rivestimento: policarbonato uv resistente

**Code**83351

Kit di fissaggio - Picchetto con staffa basculante

**Code**C-F500004

Kit di fissaggio - Picchetto con staffa basculante

**Code**C-F500005

Tappo - Rubber Poliuretano  
Materiale:Silicone, colore:Transparent.

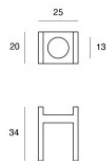
**Code**99539

Dima  
Materiale:alluminio, colore:Polished aluminium.

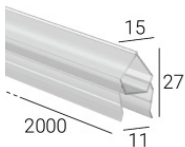
**Code**C-V200005

Profilo  
Materiale:Policarbonato UV Resistente, colore:Transparent.

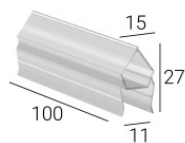
**Code**C-K100021

Profilo  
Materiale:Policarbonato UV Resistente, colore:Transparent.

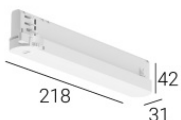
**Code**C-K100022

Accessorio elettronica - Alimentatore Track System per Rubber 3D - max 50W DC - IP20  
posizione installativa: soffitto L=218mm, H=42mm, D=31mm.  
Materiale:Plastica ABS, colore:Bianco .

**Code**C-E300007

Rubber 3D concrete | LED Strip | Accessories  
C0017WDI01004

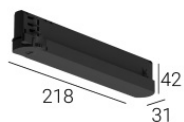

Accessorio elettronica - Alimentatore Track System per Rubber 3D  
posizione installativa: soffitto L=218mm, H=42mm, D=31mm.  
Materiale:Plastica ABS, colore:Black.

**Code**  
C-E300008



Pressacavo

**Code**  
98990



Connettore

**Code**  
89548



Strip service - Nastro biadesivo 33 metri

**Code**  
99520

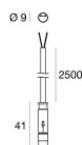

Cavo e connettore - Cavo per Rubber 3D, Rubber 3D Concrete, Rubber 3D 48V, Rubber 3D Optic  
Lunghezza 2000 mm; isolamento doppio; sezione 0.5 mm<sup>2</sup>; colori: bianco - grigio.

**Code**  
C-W200001

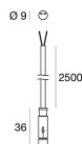

Cavo e connettore - Cavo per Rubber 3D, Rubber 3D Concrete, Rubber 3D 48V, Rubber 3D Optic  
Lunghezza 2000 mm; isolamento doppio; sezione 0.5 mm<sup>2</sup>; colori: bianco - grigio.

**Code**  
C-W200002

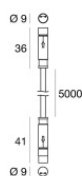

Cavo e connettore - Cavo per Rubber 3D, Rubber 3D Concrete, Rubber 3D 48V, Rubber 3D Optic  
Lunghezza 5000 mm; isolamento doppio; sezione 0.5 mm<sup>2</sup>; colori: bianco - grigio.

**Code**  
C-W200007