

LED Strip | 112 topLED 14.4 W DC 24 V | 14.4 W/m
1437 Lm/m | CRI >90
C0015MDI01004

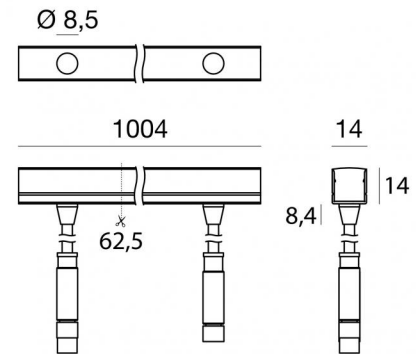

Dati tecnici	
Lunghezza	1000 mm
Taglio Minimo	62.5 mm
Tipologia	LED Strip
Posizione installativa	Parete - Soffitto
Ambiente installativo	Outdoor
Sorgente luminosa	Tecnologia LED
Struttura del circuito	topLED
Ottica	Diffused
Direzione emissione luminosa	verso l'alto
Potenza nominale	14.4 W DC
Potenza / m	14.4 W / m
Flusso luminoso sorgente	1437 lm
Flusso luminoso sorgente / m	1437 lm / m
Range di tensione in ingresso	24V
CCT / Tonalità	2700 K
Indice di resa cromatica	>90 Ra
C.C. / C.V.	CV
Classe di isolamento	3
IP	IP67
IK	IK07
Prova del filo incandescente	650°
Montaggio diretto su superfici normalmente infiammabili	Si
CE	Si
ETL	Si
Driver incluso	No
Articolo dimmerabile	DALI - 1-10V
Orientabilità	No
Basculante	No
Calpestabilità	No
Carrabilità	No
Cavo incluso	Si
Lunghezza del cavo	1(M)x0.25 m + 1(F)x0.25
Resinatura	Si
Tipologia di emissione luminosa	Singola emissione
Peso netto	0.103 Kg
Protezione scariche elettrostatiche	No
Protezione surge	No

Finitura Finitura corpo

Materiale	Tecnopolimero
Colore	Bianco

Finitura Finitura diffusore

Materiale	poliuretano
Colore	Opale

Elettronica

- 

99331
On/Off Driver 198-264V AC / V DC (1 - 10 art.)
- 

99332
1-10V Controller (1 - 10 art.)
- 

99374
On/Off Driver 198-264V AC / V DC (1 - 5 art.)
- 

83333
Push and Simply Dim - DALI-2 Controller (1 - 10 art.)
- 

C-E400002
Push and Simply Dim - DALI-2 Controller (1 - 16 art.)

LED Strip | 112 topLED 14.4 W DC 24 V | 14.4 W/m | 1437 Lm/m | CRI >90 | Base
C0015MDI01004

Led strip a singola emissione per applicazione outdoor. La sorgente luminosa LED, di colore bianco super caldo, con distribuzione luminosa Diffusa, è composta da 112 LED topLED, con una CCT 2700 K ed un CRI >90; il flusso luminoso della sorgente è di 1437 lm, con un'efficienza nominale di 99.8 lm/W.

Il corpo dell'apparecchio, realizzato in tecnopolimero, presenta una finitura di colore bianco; il diffusore è prodotto in poliuretano.

Il grado di protezione è IP67; il peso complessivo è di 0.103 kg. Il driver d'alimentazione non è fornito e deve essere ordinato separatamente.

La potenza assorbita dall'apparecchio è di 14.4 W Il cavo per l'alimentazione è incluso e presenta una lunghezza di 1(M)x0.25 m + 1(F)x0.25 m.

L'apparecchio presenta una classe di isolamento III ed è installabile a parete o soffitto su muratura con controcassa cod. 82199.

Conforme alla norma EN 60598-1 e alle relative prescrizioni particolari.

Classe di efficienza energetica

Questo prodotto contiene una sorgente luminosa di classe di efficienza energetica F.

Caratteristiche Illuminotecniche

Resa luminosa apparecchio (LOR)	53 %
Flusso luminoso sorgente	1437 lm
Flusso luminoso apparecchio	765 lm
Potenza reale apparecchio	15 W
Efficienza reale apparecchio	51 lm/W
Temperatura di colore	2700 K
Deviazione standard di corrispondenza colore	3 Step MacAdam
Indice di resa cromatica	>90 Ra
Temperatura standard dell'ambiente di esercizio	-20 / +55°C

LED Life / Failure Ratio

L70 B20 C0 72500h

L80 B20 C0 54000h

UGR

UGR axial	25.4
UGR transversal	27.8
X=4H Y=8H	S=0.25H
Reflection factor	70/50/20

OPTICAL

Ottica C90/C270	108°
Ottica C0/C180	121°
Light distribution simmetry	Symmetrical 2 assis

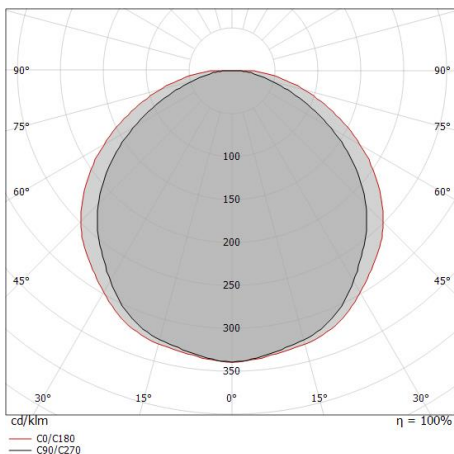

Distance [m]	Cone diameter [m]	Illuminance [lx]	E(0°)	E(C90)	E(C0)
0.5	1.38 1.76	1038 106 63	54.0°	60.4°	
1.0	2.75 3.52	260 26 16	54.0°	60.4°	
1.5	4.13 5.28	115 12 7	54.0°	60.4°	
2.0	5.51 7.04	65 7 4	54.0°	60.4°	
2.5	6.88 8.80	42 4 3	54.0°	60.4°	
3.0	8.26 10.56	29 3 2	54.0°	60.4°	

Distance [m] Cone diameter [m] Illuminance [lx]

— C0/C180 (Half-peak divergence: 120.8°)
 — C90/C270 (Half-peak divergence: 108.0°)

LED Strip | 112 topLED 14.4 W DC 24 V | 14.4 W/m | 1437 Lm/m | CRI >90
C0015MDI01004

Components

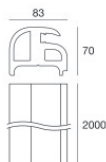
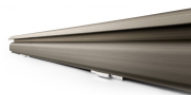

D-Wave

Code

77407

Rubber 3D | LED Strip | Accessories
C0015MDI01004

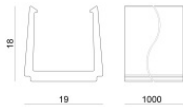

Controcassa - Profilo lineare in alluminio 19x18x1000mm per Rubber 3D, Rubber 3D Concrete, Rubber 3D 48V, Rubber 3D Optic, Rubber 3d Pixel
 posizione installativa: parete, soffitto L=1000mm, H=18mm, D=19mm.
 Materiale:alluminio, colore:alluminio, lavorazione:anodizzazione.

Code
99549

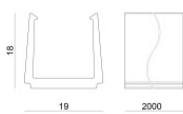
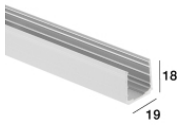

Controcassa - Profilo lineare in alluminio 19x18x2000mm per Rubber 3D, Rubber 3D Concrete, Rubber 3D 48V, Rubber 3D Optic, Rubber 3D Pixel
 posizione installativa: parete, soffitto L=2000mm, H=18mm, D=19mm.
 Materiale:alluminio, colore:alluminio, lavorazione:anodizzazione.

Code
82198

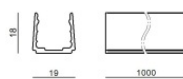

Profilo - Profilo 18x19 in alluminio nero 1m per Rubber 3D, Rubber 3D Concrete, Rubber 3D 48V, Rubber 3D Optic, Rubber 3D Pixel
 Materiale:alluminio, colore:Black, lavorazione:anodizzazione.

Code
C-K100007

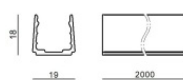

Profilo - Profilo 18x19 in alluminio nero 2m per Rubber 3D, Rubber 3D Concrete, Rubber 3D 48V, Rubber 3D Optic, Rubber 3D Pixel
 Materiale:alluminio, colore:Black, lavorazione:anodizzazione.

Code
C-K100008

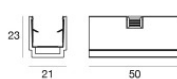

Staffa - Clip con molla dentata - Anodised Aluminium - per Rubber 3D (non per Rubber 3D PROtection)
 posizione installativa: parete, soffitto L=50mm, H=23mm, D=21mm.
 Materiale:alluminio, colore:alluminio, lavorazione:anodizzazione.

Code
C-F400001

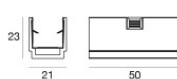

Staffa - Clip con molla dentata - Anodised Black Aluminium - per Rubber 3D (non per Rubber 3D PROtection)
 posizione installativa: parete, soffitto L=50mm, H=23mm, D=21mm.
 Materiale:alluminio, colore:Black, lavorazione:anodizzazione.

Code
C-F400002

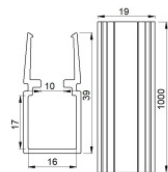
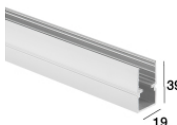

Controcassa - Profilo lineare con passaggio cavo in alluminio 39x18x1000mm per Rubber 3D, Rubber 3D Concrete, Rubber 3D 48V, Rubber 3D Optic, Rubber 3D Pixel
 posizione installativa: parete, soffitto L=1000mm, H=39mm, D=19mm.
 Materiale:alluminio, colore:alluminio, lavorazione:anodizzazione.

Code
83034

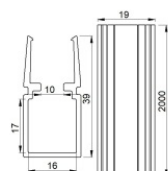

Controcassa - Profilo lineare con passaggio cavo in alluminio 39x18x2000mm per Rubber 3D, Rubber 3D Concrete, Rubber 3D 48V, Rubber 3D Optic, Rubber 3D Pixel
 posizione installativa: parete, soffitto L=2000mm, H=39mm, D=19mm.
 Materiale:alluminio, colore:alluminio, lavorazione:anodizzazione.

Code
82199

Rubber 3D | LED Strip | Accessories
C0015MDI01004

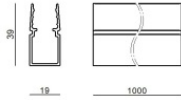

Profilo - Profilo 39x19 Alluminio nero 1m per Rubber 3D, Rubber 3D Concrete, Rubber 3D 48V, Rubber 3D Optic, Rubber 3D Pixel
 Materiale:alluminio, colore:Black, lavorazione:anodizzazione.

Code
C-K100009

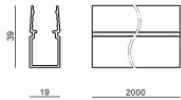

Profilo - Profilo 39x19 Alluminio nero 2m per Rubber 3D, Rubber 3D Concrete, Rubber 3D 48V, Rubber 3D Optic, Rubber 3D Pixel
 Materiale:alluminio, colore:Black, lavorazione:anodizzazione.

Code
C-K100010

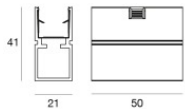

Staffa - Clip con molla dentata con passaggio cavo - Anodised Aluminium - per Rubber 3D (non per Rubber 3D PROtection)
 posizione installativa: parete, soffitto L=50mm, H=41mm, D=21mm.
 Materiale:alluminio, colore:alluminio, lavorazione:anodizzazione.

Code
C-F400003

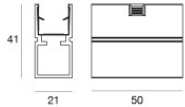

Staffa - Clip con molla dentata con passaggio cavo - Anodised Black Aluminium - per Rubber 3D (non per Rubber 3D PROtection)
 posizione installativa: parete, soffitto L=50mm, H=41mm, D=21mm.
 Materiale:alluminio, colore:Black, lavorazione:anodizzazione.

Code
C-F400004



Profilo - Profilo flessibile
 Materiale:Acciaio AISI 304, colore:acciaio.

Code
C-K100011

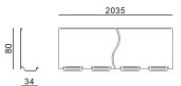

Antiabbagliamento - Palpebra anti-abbagliamento a spina di pesce
 Tipo Antiabbagliamento: palpebra.
 Materiale:Alluminio 6060, colore:Anodised aluminium, lavorazione:Anodizzazione 20 µm.

Code
C-K100032

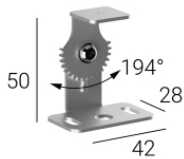

Kit di fissaggio - Kit basculazione a muro in acciaio AISI304
 Materiale:Acciaio AISI 304, colore:acciaio.

Code
C-K400168

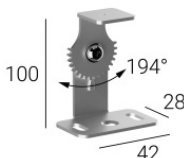

Kit di fissaggio - Kit basculazione a muro in acciaio AISI304
 Materiale:Acciaio AISI 304, colore:acciaio.

Code
C-K400169

Rubber 3D | LED Strip | Accessories
C0015MDI01004

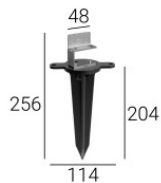

Picchetto - PICCHETTO PER RUBBER + STAFFA PICCHETTO PER RUBBER + STAFFA
PICCHETTO+STAFFA D114X204 per Rubber 3D, Rubber 3D Concrete, Rubber 3D 48V, Rubber
3D Optic, Rubber 3D Pixel
posizione installativa: terreno, Materiale rivestimento: policarbonato uv resistente

Code
83351



Kit di fissaggio - Picchetto con staffa basculante

Code
C-F500004

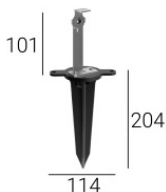

Kit di fissaggio - Picchetto con staffa basculante

Code
C-F500005



Tappo - Rubber Poliuretano
Materiale:Silicone, colore:Transparent.

Code
99539

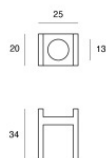

Dima
Materiale:alluminio, colore:Polished aluminium.

Code
C-V200005

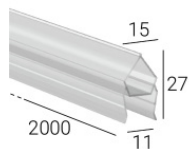

Profilo
Materiale:Policarbonato UV Resistente, colore:Transparent.

Code
C-K100021

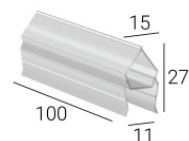

Profilo
Materiale:Policarbonato UV Resistente, colore:Transparent.

Code
C-K100022

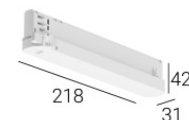

Accessorio elettronica - Alimentatore Track System per Rubber 3D - max 50W DC - IP20
posizione installativa: soffitto L=218mm, H=42mm, D=31mm.
Materiale:Plastica ABS, colore:Bianco .

Code
C-E300007

Rubber 3D | LED Strip | Accessories
C0015MDI01004

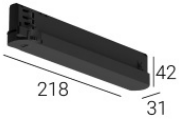

Accessorio elettronica - Alimentatore Track System per Rubber 3D
posizione installativa: soffitto L=218mm, H=42mm, D=31mm.
Materiale:Plastica ABS, colore:Black.

Code
C-E300008



Pressacavo

Code
98990



Connettore

Code
89548



Strip service - Nastro biadesivo 33 metri

Code
99520

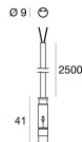

Cavo e connettore - Cavo per Rubber 3D, Rubber 3D Concrete, Rubber 3D 48V, Rubber 3D Optic
Lunghezza 2000 mm; isolamento doppio; sezione 0.5 mm²; colori: bianco - grigio.

Code
C-W200001

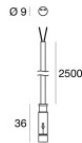

Cavo e connettore - Cavo per Rubber 3D, Rubber 3D Concrete, Rubber 3D 48V, Rubber 3D Optic
Lunghezza 2000 mm; isolamento doppio; sezione 0.5 mm²; colori: bianco - grigio.

Code
C-W200002

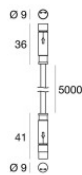

Cavo e connettore - Cavo per Rubber 3D, Rubber 3D Concrete, Rubber 3D 48V, Rubber 3D Optic
Lunghezza 5000 mm; isolamento doppio; sezione 0.5 mm²; colori: bianco - grigio.

Code
C-W200007