

LED Strip | 470 topLED 67.1 W DC 24 V | 16.01 W/m
0 Lm/m | CRI >90 | Bianco dinamico
C0014DDI04192

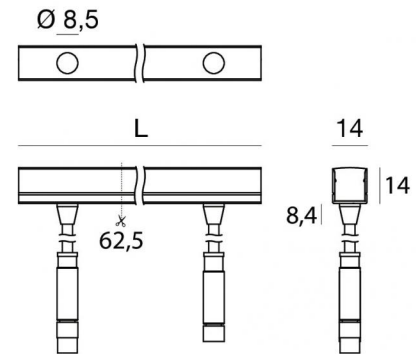

Dati tecnici	
Lunghezza	4192 mm
Tipologia	LED Strip
Posizione installativa	Parete - Soffitto
Ambiente installativo	Outdoor
Sorgente luminosa	Tecnologia LED
Struttura del circuito	topLED
Ottica	Diffused
Potenza nominale	67.1 W DC
Range di tensione in ingresso	24V
Flusso luminoso sorgente 2000K	1572 lm
Temperatura colore minima	2000 K
Flusso luminoso sorgente 6000K	1886 lm
Temperatura colore massima	6000 K
CCT / Tonalità	Bianco dinamico
Indice di resa cromatica	>90 Ra
C.C. / C.V.	CV
Classe di isolamento	3
IP	IP67
IK	IK07
Prova del filo incandescente	650°
Montaggio diretto su superfici normalmente infiammabili	Si
CE	Si
ETL	Si
Driver incluso	No
Articolo dimmerabile	Si
Orientabilità	No
Basculante	No
Calpestabilità	No
Carrabilità	No
Cavo incluso	Si
Resinatura	Si
Tipologia di emissione luminosa	Singola emissione
Peso netto	0.432 kg
Protezione scariche elettrostatiche	No
Protezione surge	No

Finitura Finitura corpo

Materiale	Tecnopolimero
Colore	Bianco

Finitura Finitura diffusore

Materiale	poliuretano
Colore	Opale

Elettronica

 99331
On/Off Driver 198-264V AC / V DC (1 - 2 art.)

 99332
1-10V Controller (1 - 2 art.)

 C-E700005
DMX-RDM Multi Channel V DC (- art.)

LED Strip | 470 topLED 67.1 W DC 24 V | 16.01 W/m | 0 Lm/m | CRI >90 | Bianco dinamico
C0014DDI04192

Led strip a singola emissione per applicazione outdoor. La sorgente luminosa LED, di colore bianco dinamico, con distribuzione luminosa Diffusa, è composta da 112 LED topLED, con una CCT From 2000 to 6000 K ed un CRI >90.

Il corpo dell'apparecchio, realizzato in tecnopolimero, presenta una finitura di colore bianco; il diffusore è prodotto in poliuretano.

Il grado di protezione è IP67; il peso complessivo è di 0.432 kg. Il driver d'alimentazione non è fornito e deve essere ordinato separatamente.

La potenza assorbita dall'apparecchio è di 67.1 W Il cavo per l'alimentazione è incluso e presenta.

L'apparecchio presenta una classe di isolamento III ed è installabile a parete o soffitto su muratura con controcassa cod. 82199.

Conforme alla norma EN 60598-1 e alle relative prescrizioni particolari.

Classe di efficienza energetica

Questo prodotto contiene una sorgente luminosa di classe di efficienza energetica F.

Caratteristiche Illuminotecniche

Deviazione standard di corrispondenza colore	3 Step MacAdam
Indice di resa cromatica	>90 Ra
Temperatura standard dell'ambiente di esercizio	-20 / +55°C

LED Life / Failure Ratio

L90 B10 C0 54000h

Rubber 3D Dynamic White | LED Strip | Accessories
C0014DDI04192

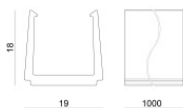

Controcassa - Profilo lineare in alluminio 19x18x1000mm per Rubber 3D, Rubber 3D Concrete, Rubber 3D 48V, Rubber 3D Optic, Rubber 3d Pixel
 posizione installativa: parete, soffitto L=1000mm, H=18mm, D=19mm.
 Materiale:alluminio, colore:alluminio, lavorazione:anodizzazione.

Code
99549

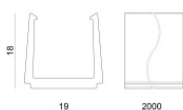

Controcassa - Profilo lineare in alluminio 19x18x2000mm per Rubber 3D, Rubber 3D Concrete, Rubber 3D 48V, Rubber 3D Optic, Rubber 3D Pixel
 posizione installativa: parete, soffitto L=2000mm, H=18mm, D=19mm.
 Materiale:alluminio, colore:alluminio, lavorazione:anodizzazione.

Code
82198



Profilo - Profilo 18x19 in alluminio nero 1m per Rubber 3D, Rubber 3D Concrete, Rubber 3D 48V, Rubber 3D Optic, Rubber 3D Pixel
 Materiale:alluminio, colore:Black, lavorazione:anodizzazione.

Code
C-K100007

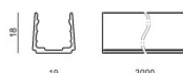

Profilo - Profilo 18x19 in alluminio nero 2m per Rubber 3D, Rubber 3D Concrete, Rubber 3D 48V, Rubber 3D Optic, Rubber 3D Pixel
 Materiale:alluminio, colore:Black, lavorazione:anodizzazione.

Code
C-K100008

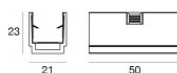

Staffa - Clip con molla dentata - Anodised Aluminium - per Rubber 3D (non per Rubber 3D PROtection)
 posizione installativa: parete, soffitto L=50mm, H=23mm, D=21mm.
 Materiale:alluminio, colore:alluminio, lavorazione:anodizzazione.

Code
C-F400001



Staffa - Clip con molla dentata - Anodised Black Aluminium - per Rubber 3D (non per Rubber 3D PROtection)
 posizione installativa: parete, soffitto L=50mm, H=23mm, D=21mm.
 Materiale:alluminio, colore:Black, lavorazione:anodizzazione.

Code
C-F400002



Controcassa - Profilo lineare con passaggio cavo in alluminio 39x18x1000mm per Rubber 3D, Rubber 3D Concrete, Rubber 3D 48V, Rubber 3D Optic, Rubber 3D Pixel
 posizione installativa: parete, soffitto L=1000mm, H=39mm, D=19mm.
 Materiale:alluminio, colore:alluminio, lavorazione:anodizzazione.

Code
83034



Controcassa - Profilo lineare con passaggio cavo in alluminio 39x18x2000mm per Rubber 3D, Rubber 3D Concrete, Rubber 3D 48V, Rubber 3D Optic, Rubber 3D Pixel
 posizione installativa: parete, soffitto L=2000mm, H=39mm, D=19mm.
 Materiale:alluminio, colore:alluminio, lavorazione:anodizzazione.

Code
82199

Rubber 3D Dynamic White | LED Strip | Accessories
C0014DDI04192



Profilo - Profilo 39x19 Alluminio nero 1m per Rubber 3D, Rubber 3D Concrete, Rubber 3D 48V, Rubber 3D Optic, Rubber 3D Pixel
 Materiale:alluminio, colore:Black, lavorazione:anodizzazione.

Code
C-K100009



Profilo - Profilo 39x19 Alluminio nero 2m per Rubber 3D, Rubber 3D Concrete, Rubber 3D 48V, Rubber 3D Optic, Rubber 3D Pixel
 Materiale:alluminio, colore:Black, lavorazione:anodizzazione.

Code
C-K100010



Staffa - Clip con molla dentata con passaggio cavo - Anodised Aluminium - per Rubber 3D (non per Rubber 3D PROtection)
 posizione installativa: parete, soffitto L=50mm, H=41mm, D=21mm.
 Materiale:alluminio, colore:alluminio, lavorazione:anodizzazione.

Code
C-F400003



Staffa - Clip con molla dentata con passaggio cavo - Anodised Black Aluminium - per Rubber 3D (non per Rubber 3D PROtection)
 posizione installativa: parete, soffitto L=50mm, H=41mm, D=21mm.
 Materiale:alluminio, colore:Black, lavorazione:anodizzazione.

Code
C-F400004



Profilo - Profilo flessibile
 Materiale:Acciaio AISI 304, colore:acciaio.

Code
C-K100011



Antiabbagliamento - Palpebra anti-abbagliamento a spina di pesce
 Tipo Antiabbagliamento: palpebra.
 Materiale:Alluminio 6060, colore:Anodised aluminium, lavorazione:Anodizzazione 20 µm.

Code
C-K100032

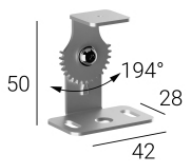

Kit di fissaggio - Kit basculazione a muro in acciaio AISI304
 Materiale:Acciaio AISI 304, colore:acciaio.

Code
C-K400168

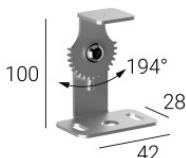

Kit di fissaggio - Kit basculazione a muro in acciaio AISI304
 Materiale:Acciaio AISI 304, colore:acciaio.

Code
C-K400169

Rubber 3D Dynamic White | LED Strip | Accessories
C0014DDI04192



Picchetto - PICCHETTO PER RUBBER + STAFFA PICCHETTO PER RUBBER + STAFFA
 PICCHETTO+STAFFA D114X204 per Rubber 3D, Rubber 3D Concrete, Rubber 3D 48V, Rubber
 3D Optic, Rubber 3D Pixel
 posizione installativa: terreno, Materiale rivestimento: policarbonato uv resistente

Code
83351



Kit di fissaggio - Picchetto con staffa basculante

Code
C-F500004



Kit di fissaggio - Picchetto con staffa basculante

Code
C-F500005



Tappo - Rubber Poliuretano
 Materiale:Silicone, colore:Transparent.

Code
99539



Dima
 Materiale:alluminio, colore:Polished aluminium.

Code
C-V200005



Profilo
 Materiale:Policarbonato UV Resistente, colore:Transparent.

Code
C-K100021



Profilo
 Materiale:Policarbonato UV Resistente, colore:Transparent.

Code
C-K100022



Accessorio elettronica - Alimentatore Track System per Rubber 3D - max 50W DC - IP20
 posizione installativa: soffitto L=218mm, H=42mm, D=31mm.
 Materiale:Plastica ABS, colore:Bianco .

Code
C-E300007

Rubber 3D Dynamic White | LED Strip | Accessories
C0014DDI04192



Accessorio elettronica - Alimentatore Track System per Rubber 3D
 posizione installativa: soffitto L=218mm, H=42mm, D=31mm.
 Materiale:Plastica ABS, colore:Black.

Code
C-E300008



Strip service - Nastro biadesivo 33 metri

Code
99520



Connettore

Code
89548



Pressacavo
 Materiale:Plastica ABS, colore:Black.

Code
C-W300001

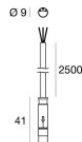

Cavo e connettore - Cavo per Rubber 3D Dynamic
 Lunghezza 2000 mm; isolamento doppio; sezione 0.5 mm²; colori: bianco - nero - grigio.

Code
C-W200003

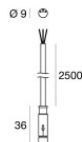

Cavo e connettore - Cavo per Rubber 3D Dynamic
 Lunghezza 2000 mm; isolamento doppio; sezione 0.5 mm²; colori: bianco - nero - grigio.

Code
C-W200004

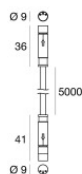

Cavo e connettore - Cavo per Rubber 3D Dynamic
 Lunghezza 5000 mm; isolamento doppio; sezione 0.5 mm²; colori: bianco - nero - grigio.

Code
C-W200009

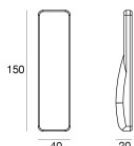

Telecomando RF - Telecomando RF 2.4G con funzioni multiple: dimmerazione, velocità, accensione/spengimento

Code
C-W600001

Rubber 3D Dynamic White | LED Strip | Accessories
C0014DDI04192

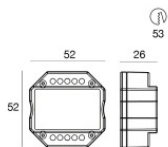

Dimmer - Smart_PRO CV | RF Remote Controller WiFi - Ingresso 12/24/48V - Uscita: 3A x 4 canali
12/24/48V
RF Remote controller

Code
C-E70002