

LED Strip | 112 topLED 5 W DC 24 V | 5 W/m  
530 Lm/m | CRI >90  
C0013WDI01004

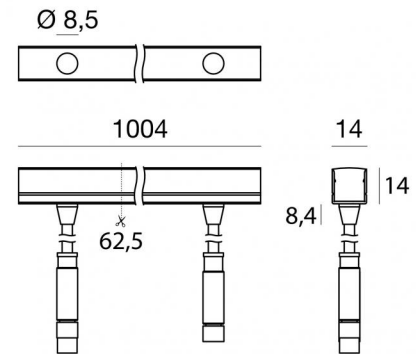

Dati tecnici	
Lunghezza	1000 mm
Taglio Minimo	62.5 mm
Tipologia	LED Strip
Posizione installativa	Parete - Soffitto
Ambiente installativo	Outdoor
Sorgente luminosa	Tecnologia LED
Struttura del circuito	topLED
Ottica	Diffused
Direzione emissione luminosa	verso l'alto
Potenza nominale	5 W DC
Potenza / m	5 W / m
Flusso luminoso sorgente	530 lm
Flusso luminoso sorgente / m	530 lm / m
Range di tensione in ingresso	24V
CCT / Tonalità	3000 K
Indice di resa cromatica	>90 Ra
C.C. / C.V.	CV
Classe di isolamento	3
IP	IP67
IK	IK07
Prova del filo incandescente	650°
Montaggio diretto su superfici normalmente infiammabili	Si
CE	Si
ETL	Si
Driver incluso	No
Articolo dimmerabile	DALI - 1-10V
Orientabilità	No
Basculante	No
Calpestabilità	No
Carrabilità	No
Cavo incluso	Si
Lunghezza del cavo	1(M)x0.25 m + 1(F)x0.25
Resinatura	Si
Tipologia di emissione luminosa	Singola emissione
Peso netto	0.103 Kg
Protezione scariche elettrostatiche	No
Protezione surge	No

**Finitura Finitura corpo**

Materiale	Tecnopolimero
Colore	Bianco

**Finitura Finitura diffusore**

Materiale	poliuretano
Colore	Opale

**Elettronica**

	99331 On/Off Driver 198-264V AC / V DC (1 - 30 art.)
	99332 1-10V Controller (1 - 30 art.)
	99374 On/Off Driver 198-264V AC / V DC (1 - 15 art.)
	83333 Push and Simply Dim - DALI-2 Controller (1 - 30 art.)
	C-E400002 Push and Simply Dim - DALI-2 Controller (1 - 48 art.)

LED Strip | 112 topLED 5 W DC 24 V | 5 W/m | 530 Lm/m | CRI >90 | Base C0013WDI01004

Led strip a singola emissione per applicazione outdoor. La sorgente luminosa LED, di colore bianco caldo, con distribuzione luminosa Diffusa, è composta da 112 LED topLED, con una CCT 3000 K ed un CRI >90; il flusso luminoso della sorgente è di 530 lm, con un'efficienza nominale di 106.0 lm/W.

Il corpo dell'apparecchio, realizzato in tecnopolimero, presenta una finitura di colore bianco; il diffusore è prodotto in poliuretano.

Il grado di protezione è IP67; il peso complessivo è di 0.103 kg. Il driver d'alimentazione non è fornito e deve essere ordinato separatamente.

La potenza assorbita dall'apparecchio è di 5 W Il cavo per l'alimentazione è incluso e presenta una lunghezza di 1(M)x0.25 m + 1(F)x0.25 m.

L'apparecchio presenta una classe di isolamento III ed è installabile a parete o soffitto su muratura con controcassa cod. 82199.

Conforme alla norma EN 60598-1 e alle relative prescrizioni particolari.

**Classe di efficienza energetica**

Questo prodotto contiene una sorgente luminosa di classe di efficienza energetica F.

**Caratteristiche Illuminotecniche**

Resa luminosa apparecchio (LOR)	50 %
Flusso luminoso sorgente	530 lm
Flusso luminoso apparecchio	270 lm
Potenza reale apparecchio	5 W
Efficienza reale apparecchio	54 lm/W
Temperatura di colore	3000 K
Deviazione standard di corrispondenza colore	3 Step MacAdam
Indice di resa cromatica	>90 Ra
Temperatura standard dell'ambiente di esercizio	-20 / +55°C

**LED Life / Failure Ratio**

L70 B20 C0 72500h

**UGR**

UGR axial	21.8
UGR transversal	24.2
X=4H   Y=8H	S=0.25H
Reflection factor	70/50/20

**OPTICAL**

Optica C90/C270	108°
Optica C0/C180	121°
Light distribution simmetry	Symmetrical 2 assis

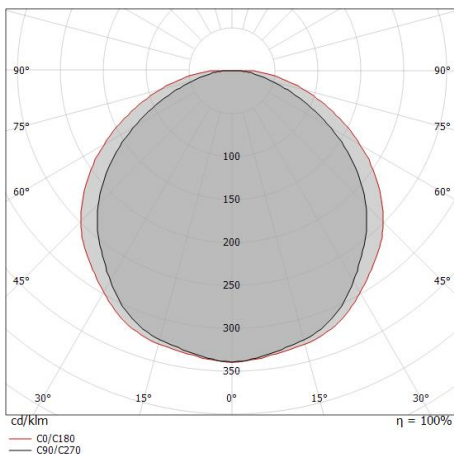

Distance [m]	Cone diameter [m]	illuminance [lx]
0.5	1.38 1.76	E(0°) 366 E(C90) 37 E(C0) 22
1.0	2.75 3.52	E(0°) 92 E(C90) 9 E(C0) 6
1.5	4.13 5.28	E(0°) 41 E(C90) 4 E(C0) 2
2.0	5.51 7.04	E(0°) 23 E(C90) 2 E(C0) 1
2.5	6.88 8.80	E(0°) 15 E(C90) 1 E(C0) 1
3.0	8.26 10.56	E(0°) 10 E(C90) 1 E(C0) 1

Distance [m]      Cone diameter [m]      illuminance [lx]

— C0/C180 (Half-peak divergence: 120.8°)  
— C90/C270 (Half-peak divergence: 108.0°)

LED Strip | 112 topLED 5 W DC 24 V | 5 W/m | 530 Lm/m | CRI >90  
**C0013WDI01004**

## Components

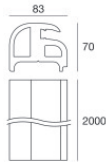
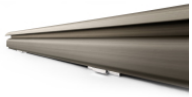

D-Wave

**Code**

77407

Rubber 3D | LED Strip | Accessories  
**C0013WDI01004**

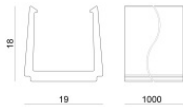

Controcassa - Profilo lineare in alluminio 19x18x1000mm per Rubber 3D, Rubber 3D Concrete, Rubber 3D 48V, Rubber 3D Optic, Rubber 3d Pixel  
 posizione installativa: parete, soffitto L=1000mm, H=18mm, D=19mm.  
 Materiale:alluminio, colore:alluminio, lavorazione:anodizzazione.

**Code**  
99549

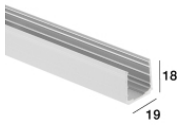

Controcassa - Profilo lineare in alluminio 19x18x2000mm per Rubber 3D, Rubber 3D Concrete, Rubber 3D 48V, Rubber 3D Optic, Rubber 3D Pixel  
 posizione installativa: parete, soffitto L=2000mm, H=18mm, D=19mm.  
 Materiale:alluminio, colore:alluminio, lavorazione:anodizzazione.

**Code**  
82198

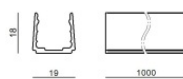

Profilo - Profilo 18x19 in alluminio nero 1m per Rubber 3D, Rubber 3D Concrete, Rubber 3D 48V, Rubber 3D Optic, Rubber 3D Pixel  
 Materiale:alluminio, colore:Black, lavorazione:anodizzazione.

**Code**  
C-K100007

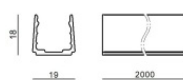

Profilo - Profilo 18x19 in alluminio nero 2m per Rubber 3D, Rubber 3D Concrete, Rubber 3D 48V, Rubber 3D Optic, Rubber 3D Pixel  
 Materiale:alluminio, colore:Black, lavorazione:anodizzazione.

**Code**  
C-K100008

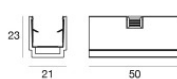

Staffa - Clip con molla dentata - Anodised Aluminium - per Rubber 3D (non per Rubber 3D PROtection)  
 posizione installativa: parete, soffitto L=50mm, H=23mm, D=21mm.  
 Materiale:alluminio, colore:alluminio, lavorazione:anodizzazione.

**Code**  
C-F400001

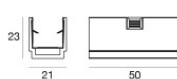

Staffa - Clip con molla dentata - Anodised Black Aluminium - per Rubber 3D (non per Rubber 3D PROtection)  
 posizione installativa: parete, soffitto L=50mm, H=23mm, D=21mm.  
 Materiale:alluminio, colore:Black, lavorazione:anodizzazione.

**Code**  
C-F400002

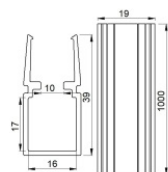
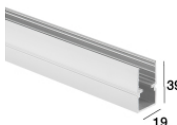

Controcassa - Profilo lineare con passaggio cavo in alluminio 39x18x1000mm per Rubber 3D, Rubber 3D Concrete, Rubber 3D 48V, Rubber 3D Optic, Rubber 3D Pixel  
 posizione installativa: parete, soffitto L=1000mm, H=39mm, D=19mm.  
 Materiale:alluminio, colore:alluminio, lavorazione:anodizzazione.

**Code**  
83034

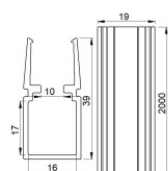

Controcassa - Profilo lineare con passaggio cavo in alluminio 39x18x2000mm per Rubber 3D, Rubber 3D Concrete, Rubber 3D 48V, Rubber 3D Optic, Rubber 3D Pixel  
 posizione installativa: parete, soffitto L=2000mm, H=39mm, D=19mm.  
 Materiale:alluminio, colore:alluminio, lavorazione:anodizzazione.

**Code**  
82199

Rubber 3D | LED Strip | Accessories  
C0013WDI01004

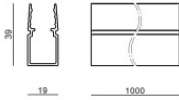

Profilo - Profilo 39x19 Alluminio nero 1m per Rubber 3D, Rubber 3D Concrete, Rubber 3D 48V, Rubber 3D Optic, Rubber 3D Pixel  
Materiale:alluminio, colore:Black, lavorazione:anodizzazione.

**Code**  
C-K100009

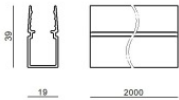

Profilo - Profilo 39x19 Alluminio nero 2m per Rubber 3D, Rubber 3D Concrete, Rubber 3D 48V, Rubber 3D Optic, Rubber 3D Pixel  
Materiale:alluminio, colore:Black, lavorazione:anodizzazione.

**Code**  
C-K100010

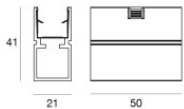

Staffa - Clip con molla dentata con passaggio cavo - Anodised Aluminium - per Rubber 3D (non per Rubber 3D PROtection)  
posizione installativa: parete, soffitto L=50mm, H=41mm, D=21mm.  
Materiale:alluminio, colore:alluminio, lavorazione:anodizzazione.

**Code**  
C-F400003

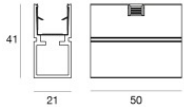

Staffa - Clip con molla dentata con passaggio cavo - Anodised Black Aluminium - per Rubber 3D (non per Rubber 3D PROtection)  
posizione installativa: parete, soffitto L=50mm, H=41mm, D=21mm.  
Materiale:alluminio, colore:Black, lavorazione:anodizzazione.

**Code**  
C-F400004



Profilo - Profilo flessibile  
Materiale:Acciaio AISI 304, colore:acciaio.

**Code**  
C-K100011

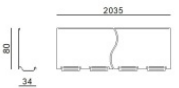
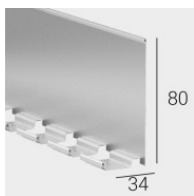

Antiabbagliamento - Palpebra anti-abbagliamento a spina di pesce  
Tipo Antiabbagliamento: palpebra.  
Materiale:Alluminio 6060, colore:Anodised aluminium, lavorazione:Anodizzazione 20 µm.

**Code**  
C-K100032

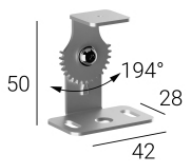

Kit di fissaggio - Kit basculazione a muro in acciaio AISI304  
Materiale:Acciaio AISI 304, colore:acciaio.

**Code**  
C-K400168

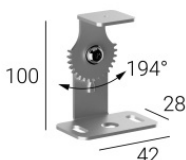

Kit di fissaggio - Kit basculazione a muro in acciaio AISI304  
Materiale:Acciaio AISI 304, colore:acciaio.

**Code**  
C-K400169

Rubber 3D | LED Strip | Accessories  
C0013WDI01004

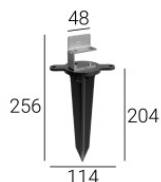

Picchetto - PICCHETTO PER RUBBER + STAFFA PICCHETTO PER RUBBER + STAFFA  
PICCHETTO+STAFFA D114X204 per Rubber 3D, Rubber 3D Concrete, Rubber 3D 48V, Rubber  
3D Optic, Rubber 3D Pixel  
posizione installativa: terreno, Materiale rivestimento: policarbonato uv resistente

**Code**  
83351



Kit di fissaggio - Picchetto con staffa basculante

**Code**  
C-F500004

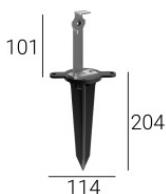

Kit di fissaggio - Picchetto con staffa basculante

**Code**  
C-F500005



Tappo - Rubber Poliuretano  
Materiale:Silicone, colore:Transparent.

**Code**  
99539

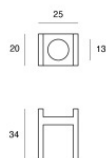

Dima  
Materiale:alluminio, colore:Polished aluminium.

**Code**  
C-V200005

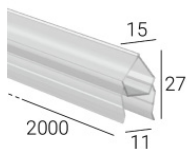

Profilo  
Materiale:Policarbonato UV Resistente, colore:Transparent.

**Code**  
C-K100021

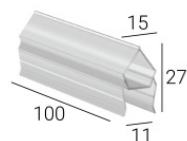

Profilo  
Materiale:Policarbonato UV Resistente, colore:Transparent.

**Code**  
C-K100022



Accessorio elettronica - Alimentatore Track System per Rubber 3D - max 50W DC - IP20  
posizione installativa: soffitto L=218mm, H=42mm, D=31mm.  
Materiale:Plastica ABS, colore:Bianco .

**Code**  
C-E300007

Rubber 3D | LED Strip | Accessories  
**C0013WDI01004**

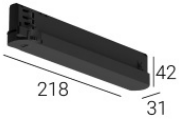

Accessorio elettronica - Alimentatore Track System per Rubber 3D  
 posizione installativa: soffitto L=218mm, H=42mm, D=31mm.  
 Materiale:Plastica ABS, colore:Black.

**Code**  
C-E300008



Pressacavo

**Code**  
98990



Connettore

**Code**  
89548



Strip service - Nastro biadesivo 33 metri

**Code**  
99520

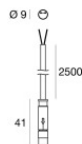

Cavo e connettore - Cavo per Rubber 3D, Rubber 3D Concrete, Rubber 3D 48V, Rubber 3D Optic  
 Lunghezza 2000 mm; isolamento doppio; sezione 0.5 mm<sup>2</sup>; colori: bianco - grigio.

**Code**  
C-W200001

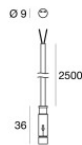

Cavo e connettore - Cavo per Rubber 3D, Rubber 3D Concrete, Rubber 3D 48V, Rubber 3D Optic  
 Lunghezza 2000 mm; isolamento doppio; sezione 0.5 mm<sup>2</sup>; colori: bianco - grigio.

**Code**  
C-W200002

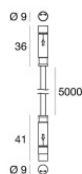

Cavo e connettore - Cavo per Rubber 3D, Rubber 3D Concrete, Rubber 3D 48V, Rubber 3D Optic  
 Lunghezza 5000 mm; isolamento doppio; sezione 0.5 mm<sup>2</sup>; colori: bianco - grigio.

**Code**  
C-W200007