

Immersione - LED Strip | 574 topLED 49.2 W DC 24 V
9.59 W/m | 1205.11 Lm/m | CRI >90
C0012NDI05129

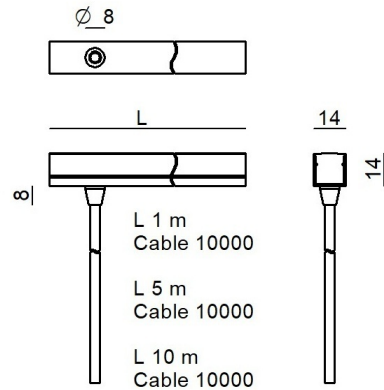

Dati tecnici	
Lunghezza	5129 mm
Tipologia	Superficie - LED Strip
Posizione installativa	Parete - Soffitto
Ambiente installativo	Outdoor
Sorgente luminosa	Tecnologia LED
Struttura del circuito	topLED
Ottica	Diffused
Potenza nominale	49.2 W DC
Potenza / m	49.2 W / m
Flusso luminoso sorgente	6181 lm
Flusso luminoso sorgente / m	6181 lm / m
Range di tensione in ingresso	24V
CCT / Tonalità	4000 K
Indice di resa cromatica	>90 Ra
C.C. / C.V.	CV
Classe di isolamento	3
IP	IP68
Limitazioni installative	Solo underwater
IK	IK07
Prova del filo incandescente	650°
Montaggio diretto su superfici normalmente infiammabili	Si
CE	Si
ETL	Si
Driver incluso	No
Articolo dimmerabile	DALI - 1-10V
Orientabilità	No
Basculante	No
Calpestabilità	No
Carrabilità	No
Cavo incluso	Si
Lunghezza del cavo	See technical drawing - 5
Resinatura	Si
Tipologia di emissione luminosa	Singola emissione
Peso netto	0.51 kg
Protezione scariche elettrostatiche	No
Protezione surge	No

Finitura Finitura corpo

Materiale Tecnopolimero
Colore Bianco

Finitura Finitura diffusore

Materiale poliuretano
Colore Opale

Elettronica

 99331
On/Off Driver 198-264V AC / V DC (1 - 3 art.)

 99332
1-10V Controller (1 - 3 art.)

 99374
On/Off Driver 198-264V AC / V DC (1 art.)

 83333
Push and Simply Dim - DALI-2 Controller (1 - 3 art.)

 C-E400002
Push and Simply Dim - DALI-2 Controller (1 - 4 art.)

Immersione - LED Strip | 574 topLED 49.2 W DC 24 V | 9.59 W/m | 1205.11 Lm/m | CRI >90
C0012NDI05129

Immersione e led strip a singola emissione per applicazione outdoor. La sorgente luminosa LED, di colore bianco naturale, con distribuzione luminosa Diffusa, è composta da 112 LED topled, con una CCT 4000 K ed un CRI >90; il flusso luminoso della sorgente è di 6181 lm, con un'efficienza nominale di 125.6 lm/W.

Il corpo dell'apparecchio, realizzato in tecnopolimero, presenta una finitura di colore bianco; il diffusore è prodotto in poliuretano.

Il grado di protezione è IP68; il peso complessivo è di 0.51 kg. Il driver d'alimentazione non è fornito e deve essere ordinato separatamente.

La potenza assorbita dall'apparecchio è di 49.2 W Il cavo per l'alimentazione è incluso e presenta una lunghezza di See technical drawing - 5 or 10 m.

L'apparecchio presenta una classe di isolamento III ed è installabile a parete o soffitto su muratura con controcassa cod. C-C300001.

Conforme alla norma EN 60598-1 e alle relative prescrizioni particolari.

Classe di efficienza energetica

Questo prodotto contiene una sorgente luminosa di classe di efficienza energetica E.

Caratteristiche Illuminotecniche

Flusso luminoso sorgente	6181 lm
Temperatura di colore	4000 K
Deviazione standard di corrispondenza colore	3 Step MacAdam
Indice di resa cromatica	>90 Ra
Temperatura standard dell'ambiente di esercizio	-20 / +55°C

LED Life / Failure Ratio

L70 B20 C0 72500h

Rubber 3D PROtection | LED Strip | Accessories
C0012NDI05129



Profilo - Profilo lineare bianco in pvc 19x18x1000mm per Rubber 3D PROtection
Materiale:Acrilonitrile Stirene Acrilato, colore:Bianco RAL 9003.

Code
C-K100002



Profilo - Profilo lineare bianco in pvc 19x18x2000mm per Rubber 3D PROtection
Materiale:Acrilonitrile Stirene Acrilato, colore:Bianco RAL 9003.

Code
C-K100001



Profilo - Profilo lineare bianco con passaggio cavo 39x19x2000mm per Rubber 3D PROtection
Materiale:Acrilonitrile Stirene Acrilato, colore:Bianco RAL 9003.

Code
C-K100004



Profilo - Profilo lineare bianco con passaggio cavo 39x19x1000mm per Rubber 3D PROtection
Materiale:Acrilonitrile Stirene Acrilato, colore:Bianco RAL 9003.

Code
C-K100005



Clip - Profilo lineare bianco in pvc 19x18x50mm per Rubber 3D PROtection
posizione installativa: parete, soffitto

Code
C-K100003



Profilo - Profilo lineare bianco con passaggio cavo 39x19x50mm per Rubber 3D PROtection
Materiale:Acrilonitrile Stirene Acrilato, colore:Bianco RAL 9003.

Code
C-K100006



Controcassa - Controcassa + pressacavo piscine in cemento
L=300mm, H=36mm, D=36mm.
Materiale:Plastica ABS, colore:Black.

Code
C-C300001



Dima
Materiale:alluminio, colore:Polished aluminium.

Code
C-V200005

Rubber 3D PROtection | LED Strip | Accessories

C0012NDI05129

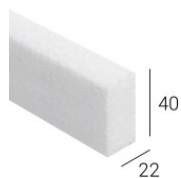

Dima - Kit predisposizione Rubber - listello in PSE

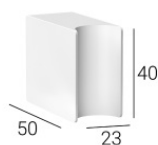
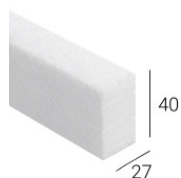
Code99521**Code**C-K400165

Dima - Kit predisposizione Rubber - listello in PSE

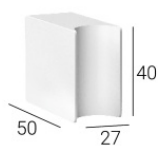
CodeC-K400170**Code**C-K400171

Pressacavo

Code98990

Connettore

Code89548

Pressacavo

Materiale:Plastica ABS, colore:Black.

CodeC-W300001

Strip service - Nastro biadesivo 33 metri

Code99520

Rubber 3D PROtection | LED Strip | Accessories

C0012NDI05129
