

Sistemi | 198-264 V | 288 topLED 54 W DC - 58 W AC | CRI 90  
**9866M**

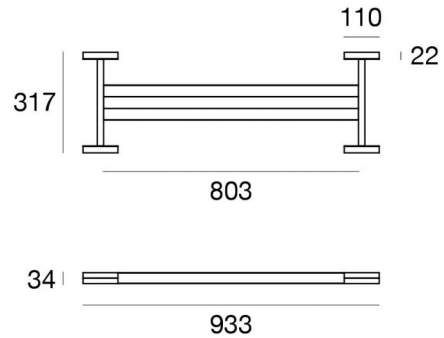

Dati tecnici	
Tipologia	Sistemi
Posizione installativa	Cavo
Ambiente installativo	Indoor
Sorgente luminosa	Tecnologia LED
Struttura del circuito	topLED
Ottica	Diffused
Direzione emissione luminosa	verso il basso e verso l'alto
Potenza nominale	54 W DC
Potenza totale	58 W
Flusso luminoso sorgente	5370 lm
Tensione nominale di ingresso	220 - 240 V AC
Range di tensione in ingresso	198 - 264 V AC
Frequenza	50 - 60 Hz
CCT / Tonalità	2700 K
Indice di resa cromatica	90 Ra
C.C. / C.V.	AC
Classe di isolamento	2
IP	IP20
Prova del filo incandescente	850°
Montaggio diretto su superfici normalmente infiammabili	Si
CE	Si
Driver incluso	Driver
Articolo dimmerabile	No
Orientabilità	No
Basculante	No
Calpestabilità	No
Carrabilità	No
Cavo incluso	No
Resinatura	No
Tipologia di emissione luminosa	Doppia emissione
Peso netto	1.800 Kg
Protezione scariche elettrostatiche	No
Protezione surge	No

Finitura Finitura corpo	
Materiale	alluminio
Colore	Text black (R9005)
Lavorazione	verniciatura
Finitura Finitura diffusore	
Materiale	policarbonato
Colore	Opalino

Sistemi | 198-264 V | 288 topLED 54 W DC - 58 W AC | CRI 90 | Base  
**9866M**

Sistemi a doppia emissione per applicazione indoor. La sorgente luminosa LED, di colore bianco super caldo, con distribuzione luminosa Diffusa, è composta da 288 LED topLED, con una CCT 2700 K ed un CRI 90; il flusso luminoso della sorgente è di 5370 lm, con un'efficienza nominale di 99.4 lm/W.

Il corpo dell'apparecchio, realizzato in alluminio, presenta una finitura di colore text black (r9005), ottenuta tramite verniciatura; il diffusore è prodotto in policarbonato.

Il grado di protezione è IP20; il peso complessivo è di 1.800 kg.

La potenza assorbita dall'apparecchio è di 58 W

L'apparecchio presenta una classe di isolamento II ed è installabile a cavo.

Conforme alla norma EN 60598-1 e alle relative prescrizioni particolari.

#### Classe di efficienza energetica

Questo prodotto contiene 6 sorgenti luminose di classe di efficienza energetica F.

#### Caratteristiche Illuminotecniche

Resa luminosa apparecchio (LOR)	67 %
Flusso luminoso sorgente	5370 lm
Flusso luminoso apparecchio	3613 lm
Potenza reale apparecchio	58 W
Efficienza reale apparecchio	62 lm/W
Temperatura di colore	2700 K
Deviazione standard di corrispondenza colore	3 Step MacAdam
Indice di resa cromatica	90 Ra
Temperatura di giunzione nell'apparecchio	80
Temperatura standard dell'ambiente di esercizio	25°C

#### LED Life / Failure Ratio

L70 B20 C0 72500h (at Tj 115 Ta 25 )

#### UGR

UGR axial	23.8
UGR transversal	28.3
X=4H   Y=8H	S=0.25H
Reflection factor	70/50/20

#### OPTICAL

Ottica C0/C180	180°
Light distribution simmetry	Symmetrical

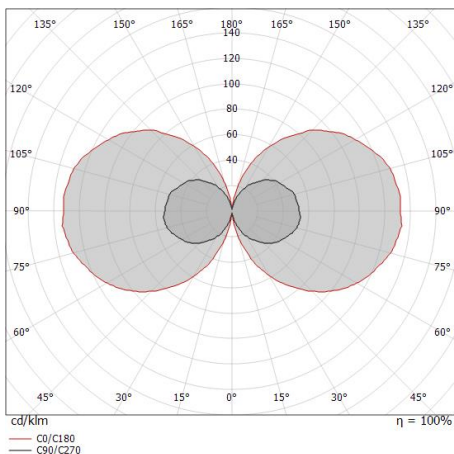

Sistemi | 198-264 V | 288 topLED 54 W DC - 58 W AC | CRI 90







9866M

## Components

		<p>300 System Accessories - Sistemi</p>	<p><b>Code</b> <u>TR4101-4</u></p>
		<p>300 System Accessories - Sistemi</p>	<p><b>Code</b> <u>TR4101-5</u></p>
		<p>300 System Accessories - Sistemi</p>	<p><b>Code</b> <u>TR4103-4</u></p>
		<p>300 System Accessories - Sistemi</p>	<p><b>Code</b> <u>TR4103-5</u></p>
		<p>300 System Accessories</p>	<p><b>Code</b> <u>TR4104-3</u></p>
		<p>300 System Accessories - 1.5m - Grey - Sistemi</p>	<p><b>Code</b> <u>TR4105-5</u></p>
		<p>300 System Accessories</p>	<p><b>Code</b> <u>TR4109-4</u></p>
		<p>300 System Accessories</p>	<p><b>Code</b> <u>TR4109-5</u></p>

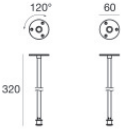

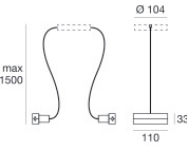





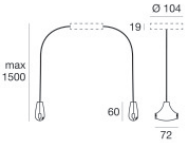

Sistemi | 198-264 V | 288 topLED 54 W DC - 58 W AC | CRI 90  
**9866M**

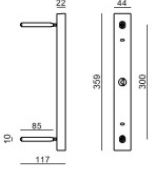
## Components

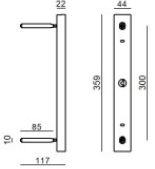
	Supporting cable - 50m - Sistemi	<p><b>Code</b> <u>TR4151-50</u></p>
	Supporting cable - 30m - Sistemi	<p><b>Code</b> <u>TR4151-30</u></p>
	Supporting cable - 20m - Sistemi	<p><b>Code</b> <u>TR4151-20</u></p>
	Supporting cable - 10m - Sistemi	<p><b>Code</b> <u>TR4151-10</u></p>
	Supporting cable - 5m - Sistemi	<p><b>Code</b> <u>TR4151-5</u></p>
	300 System Accessories - 1.5m - White - Sistemi	<p><b>Code</b> <u>TR4105-4R</u></p>
 	300 System Accessories - Sistemi	<p><b>Code</b> <u>8721</u></p>
 	300 System Accessories - Sistemi	<p><b>Code</b> <u>8722</u></p>

Sistemi | 198-264 V | 288 topLED 54 W DC - 58 W AC | CRI 90  
**9866M**

## Components

		300 System Accessories - Sistemi	<b>Code</b> <u>8729</u>
		300 System Accessories - Sistemi	<b>Code</b> <u>9873</u>
		300 System Accessories	<b>Code</b> <u>9874</u>
		Supporting black cable - 5m	<b>Code</b> <u>TR4153-5</u>
		Supporting black cable - 10m - Sistemi	<b>Code</b> <u>TR4153-10</u>
		Supporting black cable - 20m - Sistemi	<b>Code</b> <u>TR4153-20</u>
		Supporting black cable - 30m - Sistemi	<b>Code</b> <u>TR4153-30</u>
		Supporting black cable - 50m - Sistemi	<b>Code</b> <u>TR4153-50</u>

Sistemi | 198-264 V | 288 topLED 54 W DC - 58 W AC | CRI 90

9866M

## Components

		<p>300 System Accessories - Sistemi</p>	<p><b>Code</b> <u>TR4124-4</u></p>
		<p>300 System Accessories - Sistemi</p>	<p><b>Code</b> <u>TR4124-5</u></p>
		<p>300 System Accessories - Sistemi</p>	<p><b>Code</b> <u>TR4124-6</u></p>
		<p>300 System Accessories - 1.5m - Grey - Sistemi</p>	<p><b>Code</b> <u>TR4105-6</u></p>
		<p>300 System Accessories - Sistemi</p>	<p><b>Code</b> <u>TR4103-6</u></p>
		<p>300 System Accessories - Sistemi</p>	<p><b>Code</b> <u>TR4101-6</u></p>
		<p>300 System Accessories - Sistemi</p>	<p><b>Code</b> <u>TR4109-6</u></p>
		<p>300 System Accessories - Sistemi</p>	<p><b>Code</b> <u>8730</u></p>

Sistemi | 198-264 V | 288 topLED 54 W DC - 58 W AC | CRI 90  
**9866M**

## Components

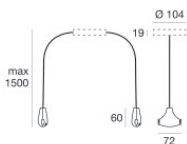

300 System Accessories - Sistemi

Code

8731