

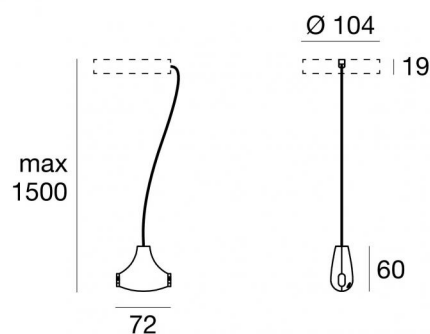

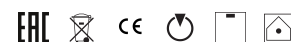









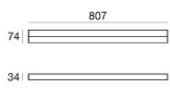

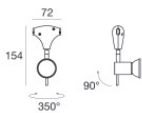

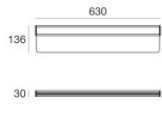
Sistemi
8706

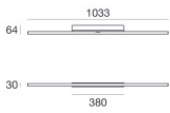
Dati tecnici	
Tipologia	Mono System
Posizione installativa	Soffitto
Ambiente installativo	Indoor
Lampadina inclusa	No
Prova del filo incandescente	850°
Montaggio diretto su superfici normalmente infiammabili	Si
CE	Si
Articolo dimmerabile	No
Orientabilità	No
Basculante	No
Calpestabilità	No
Carrabilità	No
Cavo incluso	No
Resinatura	No
Peso netto	0.20 Kg

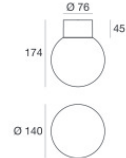
Finitura Finitura corpo	
Materiale	Plastica ABS - policarbonato
Colore	Text white (R9003) - Text white (R9003)
Lavorazione	verniciatura

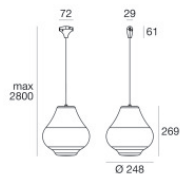

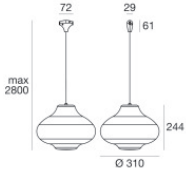







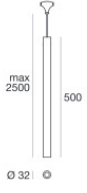

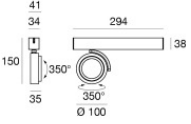

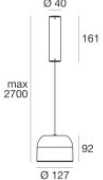
Sistemi
8706

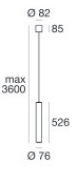
Components

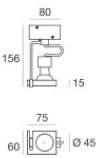
		Iota-C	<p>Code 9857 - 9859 - 9860 - 9858 - 9855 - 9856 - 9855M - 9856M - 9855N - 9856N - 9857M - 9858M - 9857N - 9858N - 9859M - 9860M - 9859N - 9860N</p>
		Andromeda-C_1	<p>Code <u>TR4304-5 - TR4304-4R - TR4304-6</u></p>
		Trix-C	<p>Code <u>8430 - 8429 - 8431</u></p>
		Circular	<p>Code <u>8445 - 8446 - 8447</u></p>
		Oh!-C1	<p>Code <u>10115 - 10116</u></p>
		Sisters-C_248	<p>Code <u>8653</u></p>
		Sisters-C_310	<p>Code <u>8656</u></p>
		Baton-C_1	<p>Code <u>64652 - 64653</u></p>

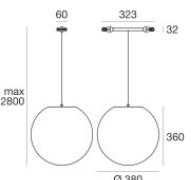
Sistemi
8706

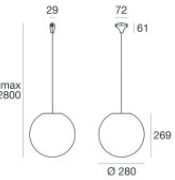
Components

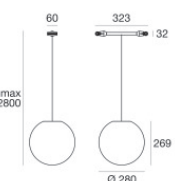
		Baton-C_2	Code <u>64656 - 64657</u>
		Eta-C	Code <u>9872 - 9871 - 9869 - 9870 - 9868 - 9867 - 9867M - 9870M - 9868M - 9871M - 9869M - 9872M - 9867N - 9870N - 9868N - 9871N - 9869N - 9872N</u>
		Outlook-C	Code <u>8422</u>
		Tu-V-C	Code <u>8650</u>
		Orion-C_2	Code <u>59744 - 59745</u>
		Oh!-C30_380	Code <u>12145</u>
		Oh!-C2_280	Code <u>12140</u>
		Oh!-C30_280	Code <u>12142</u>

Sistemi
8706

Components
