

Sistemi
8705

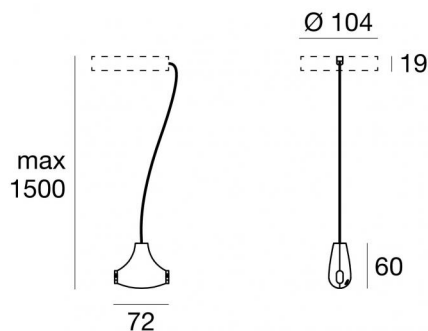

Dati tecnici	
Tipologia	Mono System
Posizione installativa	Soffitto
Ambiente installativo	Indoor
Lampadina inclusa	No
IP	IP40
Prova del filo incandescente	850°
Montaggio diretto su superfici normalmente incombustibili	Si
CE	Si
Articolo dimmerabile	No
Orientabilità	No
Basculante	No
Calpestabilità	No
Carrabilità	No
Cavo incluso	Si
Lunghezza del cavo	1,5 m
Resinatura	No
Peso netto	0.20 Kg

Finitura Finitura corpo	
Materiale	Plastica ABS - policarbonato
Colore	Text black (R9005) - Text black (R9005)
Lavorazione	verniciatura - verniciatura

Sistemi
8705

Components





Iota-C

Code
9860 - 9856 - 9858 - 9855 - 9857 - 9859 -
9855M - 9856M - 9855N - 9856N - 9858M
- 9858N - 9860M - 9860N - 9857M -
9857N - 9859M - 9859N





Trix-C

Code
8430 - 8431 - 8429



Circular

Code
8445 - 8446 - 8447



Oh!-C1

Code
10115 - 10116





Outlook-C

Code
8422

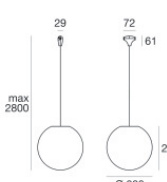

Andromeda-C_1

Code
TR4304-4R - TR4304-5 - TR4304-6

Oh!-C2_280

Code
12140





Tu-V-C

Code
8650

Sistemi
8705

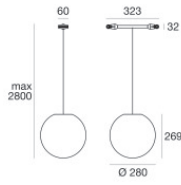
Components



Oh!-C30_280

Code
12142

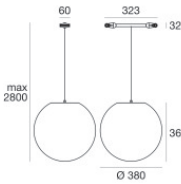

Oh!-C30_380

Code
12145

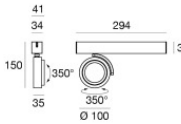

Eta-C

Code
9870 - 9871 - 9872 - 9867M - 9870M -
9868M - 9871M - 9869M - 9872M -
9867N - 9870N - 9868N - 9871N - 9869N
- 9872N - 9867 - 9868 - 9869