

Proiettori | 198-264 V
16 x powerLEDs 27 W DC - 30 W AC | CRI 90
83923N07

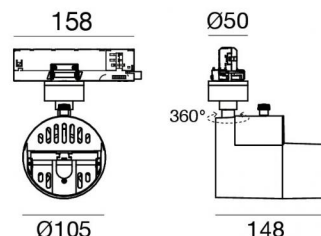

Dati tecnici	
Tipologia	Binario
Posizione installativa	Soffitto
Ambiente installativo	Indoor
Sorgente luminosa	Tecnologia LED
Struttura del circuito	powerLEDs
Ottica	Adjustable Wall Washer
Direzione emissione luminosa	frontale
Potenza nominale	27 W DC
Potenza totale	30 W
Flusso luminoso sorgente	4103 lm
Tensione nominale di ingresso	220 - 240 V AC
Range di tensione in ingresso	198 - 264 V AC
Frequenza	50 - 60 Hz
CCT / Tonalità	4000 K
Indice di resa cromatica	90 Ra
C.C. / C.V.	AC
Classe di isolamento	2
IP	IP20
Prova del filo incandescente	850°
Montaggio diretto su superfici normalmente infiammabili	Si
CE	Si
Driver incluso	Driver
Articolo dimmerabile	Bluetooth
Orientabilità	Orientabile
angolo totale (piano verticale)	90 °
angolo totale (piano orizzontale)	360 °
Basculante	No
Calpestabilità	No
Carrabilità	No
Cavo incluso	No
Resinatura	No
Tipologia di emissione luminosa	Singola emissione
Peso netto	1.152 Kg
Protezione scariche elettrostatiche	Si
Protezione surge	2 KV

Finitura Finitura corpo	
Materiale	Alluminio Pressofuso EN AB - 46100
Colore	Text white (R9003)
Lavorazione	Verniciatura a polvere termoidurente

Technology Partner
SILVAIR

Proiettori | 198-264 V | 16 x powerLEDs 27 W DC - 30 W AC | CRI 90 | Chiuso
83923N07

Proiettori a singola emissione per applicazione indoor. La sorgente luminosa LED, di colore bianco naturale, con distribuzione luminosa Adjustable Wall Washer, è composta da 16 LED powered, con una CCT 4000 K ed un CRI 90; il flusso luminoso della sorgente è di 4103 lm, con un'efficienza nominale di 152.0 lm/W.

Il corpo dell'apparecchio, realizzato in alluminio pressofuso en ab - 46100, presenta una finitura di colore text white (r9003), ottenuta tramite verniciatura a polvere termoidurente.

Il grado di protezione è IP20; il peso complessivo è di 1.152 kg.

La potenza assorbita dall'apparecchio è di 30 W

L'apparecchio presenta una classe di isolamento II ed è installabile a soffitto.

Conforme alla norma EN 60598-1 e alle relative prescrizioni particolari.

Classe di efficienza energetica

Questo prodotto contiene 2 sorgenti luminose di classe di efficienza energetica E.

Caratteristiche Illuminotecniche

Resa luminosa apparecchio (LOR)	28 %
Flusso luminoso sorgente	4103 lm
Flusso luminoso apparecchio	1165 lm
Potenza reale apparecchio	30 W
Efficienza reale apparecchio	38 lm/W
Temperatura di colore	4000 K
Deviazione standard di corrispondenza colore	3 Step MacAdam
Indice di resa cromatica	90 Ra
Temperatura standard dell'ambiente di esercizio	-20 / +50°C
Temperatura tipica sul vetro	40°C

LED Life / Failure Ratio

- L70 B10 C0 363000h (at Tj 65 Ta 25)
- L80 B10 C0 237566h (at Tj 65 Ta 25)
- L90 B10 C0 151000h (at Tj 65 Ta 25)

OPTICAL

Ottica C0/C180	63°
Light distribution simmetry	Asymmetrical

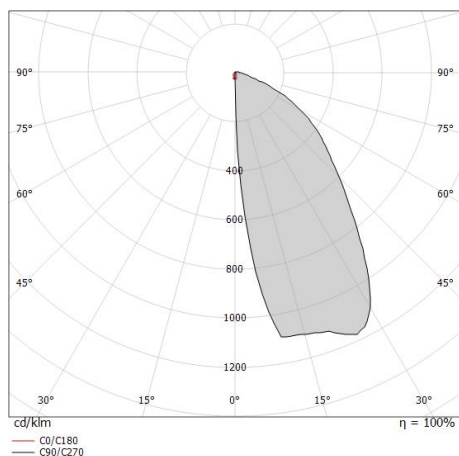

Distance [m]	Cone diameter [m]	Illuminance [lx]
0.5	0.62	E(0°) 124 E(C0) 41
1.0	1.24	E(0°) 31 E(C0) 10
1.5	1.85	E(0°) 14 E(C0) 5
2.0	2.47	E(0°) 8 E(C0) 3
2.5	3.09	E(0°) 5 E(C0) 2
3.0	3.71	E(0°) 3 E(C0) 1

Distance [m] Cone diameter [m] Illuminance [lx]
 — C0/C180 (Half-peak divergence: 63.4°)

Proiettori | 198-264 V | 16 x powerLEDs 27 W DC - 30 W AC | CRI 90 | Aperto

83923N07

Proiettori a singola emissione per applicazione indoor. La sorgente luminosa LED, di colore bianco naturale, con distribuzione luminosa Adjustable Wall Washer, è composta da 16 LED powered, con una CCT 4000 K ed un CRI 90; il flusso luminoso della sorgente è di 4103 lm, con un'efficienza nominale di 152.0 lm/W.

Il corpo dell'apparecchio, realizzato in alluminio pressofuso en ab - 46100, presenta una finitura di colore text white (r9003), ottenuta tramite verniciatura a polvere termoidurente.

Il grado di protezione è IP20; il peso complessivo è di 1.152 kg.

La potenza assorbita dall'apparecchio è di 30 W

L'apparecchio presenta una classe di isolamento II ed è installabile a soffitto.

Conforme alla norma EN 60598-1 e alle relative prescrizioni particolari.

Classe di efficienza energetica

Questo prodotto contiene 2 sorgenti luminose di classe di efficienza energetica E.

Caratteristiche Illuminotecniche

Resa luminosa apparecchio (LOR)	34 %
Flusso luminoso sorgente	4103 lm
Flusso luminoso apparecchio	1436 lm
Potenza reale apparecchio	30 W
Efficienza reale apparecchio	47 lm/W
Temperatura di colore	4000 K
Deviazione standard di corrispondenza colore	3 Step MacAdam
Indice di resa cromatica	90 Ra
Temperatura standard dell'ambiente di esercizio	-20 / +50°C
Temperatura tipica sul vetro	40°C

LED Life / Failure Ratio

L70 B10 C0 363000h (at Tj 65 Ta 25)

L80 B10 C0 237566h (at Tj 65 Ta 25)

L90 B10 C0 151000h (at Tj 65 Ta 25)

OPTICAL

Ottica C0/C180	57°
Light distribution simmetry	Asymmetrical

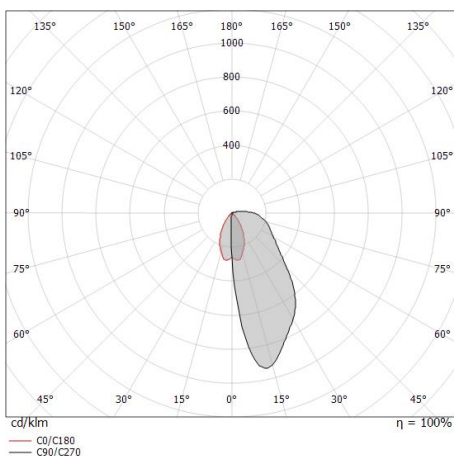

Distance [m]	Cone diameter [m]	Illuminance [lx]
0.5	0.54	E(0°) 1495 E(C0) 546
1.0	1.09	E(0°) 374 E(C0) 136
1.5	1.63	E(0°) 166 E(C0) 61
2.0	2.17	E(0°) 93 E(C0) 34
2.5	2.71	E(0°) 60 E(C0) 22
3.0	3.26	E(0°) 42 E(C0) 15

Distance [m] Cone diameter [m] Illuminance [lx]
— C0/C180 (Half-peak divergence: 57.0°)

Optus_Ww | Projectors | Accessories
83923N07

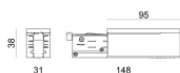

Power Supply - Testata di alimentazione destra bianca (9001/W)
Materiale:policarbonato, colore:Bianco .

Code
81033

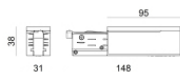

Power Supply - Testata di alimentazione sinistra bianca (9002/W)
Materiale:policarbonato, colore:Bianco .

Code
81036

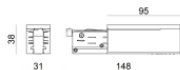

Power Supply - Testata di alimentazione sinistra nera (9002/B)
Materiale:policarbonato, colore:Black.

Code
81037

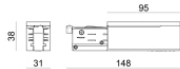

Power Supply - Testata di alimentazione destra nera (9001/B)
Materiale:policarbonato, colore:Black.

Code
81034



Tappo - Tappo di chiusura bianco 9004/W
Materiale:policarbonato, colore:Bianco .

Code
80999



Tappo - Tappo di chiusura nero 9004/B
Materiale:policarbonato, colore:Black.

Code
81000



Tappo - Tappo di chiusura bianco per incasso 9004-R/W
Materiale:policarbonato, colore:Bianco .

Code
81002



Tappo - Tappo di chiusura nero per incasso 9004-R/B
Materiale:policarbonato, colore:Black.

Code
81003

Optus_Ww | Projectors | Accessories
83923N07

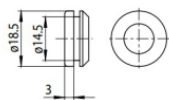

Tappo - Guarnizione bianca (S-9001/115-W)
Materiale:Bianco .

Code
81084

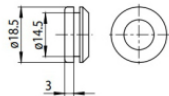

Tappo - Guarnizione nera (S-9001/115-B)
Materiale:Nero , colore:Black.

Code
81085



Rosone - Kit sospensione bianco 1.5m + staffa (9000-KIT5-1,5-W)
Driver incluso: No.
Materiale:plastica, colore:Bianco .

Code
81012

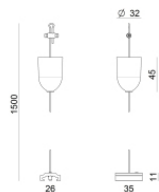

Rosone - Kit sospensione nero 1.5m + staffa (9000-KIT5-1,5-B)
Driver incluso: No.
Materiale:plastica, colore:Black.

Code
81014

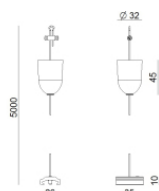

Rosone - Kit sospensione bianco 5m + staffa (9000-KIT5-5-W)
Driver incluso: No.
Materiale:plastica, colore:Bianco .

Code
81013



Rosone - Kit sospensione nero 5m + staffa (9000-KIT5-5-B)
Driver incluso: No.
Materiale:plastica, colore:Black.

Code
81015



Staffa - Staffa anodizzata per fissaggio a soffitto (S-9000/131)
L=35mm, H=14mm, D=24mm.
Materiale:alluminio, colore:Polished aluminium.

Code
81086



Staffa - Staffa anodizzata di irrigidimento (S-9000/333)
L=180mm, H=24mm, D=26mm.
Materiale:alluminio, colore:Anodised aluminium, lavorazione:anodizzazione.

Code
81024

Optus_Ww | Projectors | Accessories
83923N07



Staffa - Staffa bianca di irrigidimento (S-9000/333-W)

L=180mm, H=24mm, D=20mm.

Materiale:alluminio, colore:Bianco RAL 9010, lavorazione:verniciatura.

Code

81025



Staffa - Staffa nera di irrigidimento (S-9000/333-B)

L=180mm, H=24mm, D=20mm.

Materiale:alluminio, colore:Nero RAL 9005, lavorazione:verniciatura.

Code

81026



Staffa - Staffa bianca per fissaggio a soffitto (S-9000/131-W)

L=35mm, H=14mm, D=24mm.

Materiale:alluminio, colore:Bianco , lavorazione:verniciatura.

Code

81087



Staffa - Staffa nera per fissaggio a soffitto (S-9000/131-B)

L=35mm, H=14mm, D=24mm.

Materiale:alluminio, colore:Text black (R9005), lavorazione:verniciatura.

Code

81088

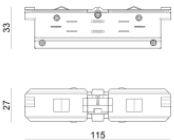

Giunzione - Giunto elettrico bianco - interno (9003/W)

Tipologia linear.

Materiale:policarbonato, colore:Bianco .

Code

81039

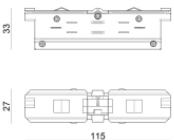

Giunzione - Giunto elettrico nero - interno (9003/B)

Tipologia linear.

Materiale:policarbonato, colore:Black.

Code

81040



Giunzione - Giunto di alimentazione bianco - centrale (9010/W)

Tipologia linear.

Materiale:policarbonato, colore:Bianco .

Code

81042

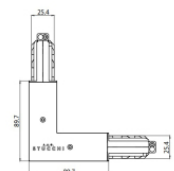

Giunzione - Giunto a L bianco - interno (9011/W)

Tipologia linear.

Materiale:policarbonato, colore:Bianco .

Code

81045

Optus_Ww | Projectors | Accessories
83923N07

		<p>Giunzione - Giunto a L bianco - esterno (9012/W)</p> <p>Tipologia linear.</p> <p>Materiale:policarbonato, colore:Bianco .</p>	<p>Code <u>81048</u></p>
		<p>Giunzione - Giunto flessibile bianco (9018/W)</p> <p>Tipologia flexible curve.</p> <p>Materiale:policarbonato, colore:Bianco .</p>	<p>Code <u>81066</u></p>
		<p>Giunzione - Giunto a X bianco (9017/W)</p> <p>Tipologia linear.</p> <p>Materiale:policarbonato, colore:Bianco .</p>	<p>Code <u>81063</u></p>
		<p>Giunzione - Giunto a T sinistro bianco - esterno (9013/W)</p> <p>Tipologia linear.</p> <p>Materiale:policarbonato, colore:Bianco .</p>	<p>Code <u>81051</u></p>
		<p>Giunzione - Giunto a T destro bianco - esterno (9014/W)</p> <p>Tipologia linear.</p> <p>Materiale:policarbonato, colore:Bianco .</p>	<p>Code <u>81054</u></p>
		<p>Giunzione - Giunto a T bianco sinistro - interno (9015/W)</p> <p>Tipologia linear.</p> <p>Materiale:policarbonato, colore:Bianco .</p>	<p>Code <u>81057</u></p>
		<p>Giunzione - Giunto a T bianco destro - interno (9016/W)</p> <p>Tipologia linear.</p> <p>Materiale:policarbonato, colore:Bianco .</p>	<p>Code <u>81060</u></p>
		<p>Giunzione - Giunto di alimentazione nero - centrale (9010/B)</p> <p>Tipologia linear.</p> <p>Materiale:policarbonato, colore:Black.</p>	<p>Code <u>81043</u></p>

Optus_Ww | Projectors | Accessories
83923N07

		<p>Giunzione - Giunto a L nero - interno (9011/B)</p> <p>Tipologia linear.</p> <p>Materiale:policarbonato, colore:Black.</p>	<p>Code <u>81046</u></p>
		<p>Giunzione - Giunto a L nero - esterno (9012/B)</p> <p>Tipologia linear.</p> <p>Materiale:policarbonato, colore:Black.</p>	<p>Code <u>81049</u></p>
		<p>Giunzione - Giunto flessibile nero (9018/B)</p> <p>Tipologia flexible curve.</p> <p>Materiale:policarbonato, colore:Black.</p>	<p>Code <u>81067</u></p>
		<p>Giunzione - Giunto a X nero (9017/B)</p> <p>Tipologia linear.</p> <p>Materiale:policarbonato, colore:Black.</p>	<p>Code <u>81064</u></p>
		<p>Giunzione - Giunto a T sinistro nero - esterno (9013/B)</p> <p>Tipologia linear.</p> <p>Materiale:policarbonato, colore:Black.</p>	<p>Code <u>81052</u></p>
		<p>Giunzione - Giunto a T destro nero - esterno (9014/B)</p> <p>Tipologia linear.</p> <p>Materiale:policarbonato, colore:Black.</p>	<p>Code <u>81055</u></p>
		<p>Giunzione - Giunto a T nero sinistro - interno (9015/B)</p> <p>Tipologia linear.</p> <p>Materiale:policarbonato, colore:Black.</p>	<p>Code <u>81058</u></p>
		<p>Giunzione - Giunto a T destro nero - interno (9016/B)</p> <p>Tipologia linear.</p> <p>Materiale:policarbonato, colore:Black.</p>	<p>Code <u>81061</u></p>

Optus_Ww | Projectors | Accessories
83923N07



Sospensioni - Kit sospensione bianco 1.5m (9000-KIT3-1,5-W)
Materiale:plastica, colore:Bianco .

Code
81006



Sospensioni - Kit sospensione bianco 5m (9000-KIT3-5-W)
Materiale:plastica, colore:Bianco .

Code
81007

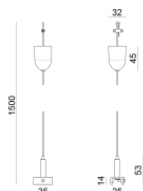

Sospensioni - Kit sospensione nero 1.5m (9000-KIT3-1,5-B)
Materiale:plastica, colore:Black.

Code
81008

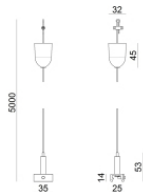

Sospensioni - Kit sospensione nero 5m (9000-KIT3-5-B)
Materiale:plastica, colore:Black.

Code
81009



Sospensioni - Clip per sospensione rigida bianca (S-9000-P2-W)
Materiale:plastica, colore:Bianco .

Code
81018



Sospensioni - Clip per sospensione rigida nera (S-9000-P2-B)
Materiale:plastica, colore:Black.

Code
81019



Sospensioni - Sospensione rigida 1m bianca (S-9000-P3-W)
Materiale:plastica, colore:Bianco .

Code
81021











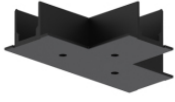
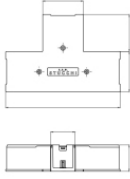
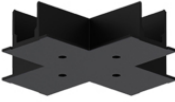

Sospensioni - Sospensione rigida 1m nera (S-9000-P3-B)
Materiale:plastica, colore:Black.

Code
81022

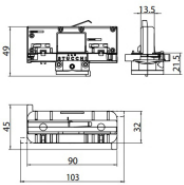
Optus_Ww | Projectors | Accessories
83923N07

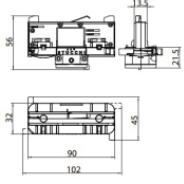
		Coprifilo - Copertura per testata ad incasso bianca (S-9001-R/6-W) Materiale:policarbonato, colore:Bianco .	Code <u>81069</u>
		Coprifilo - Copertura per giunto ad incasso bianco (S-9010-R/6-W) Materiale:policarbonato, colore:Bianco .	Code <u>81072</u>
		Coprifilo - Copertura per giunto L incassato bianco (S-9011-R/6-W) Materiale:policarbonato, colore:Bianco .	Code <u>81075</u>
		Coprifilo - Coperture per giunto T incassato bianco (S-9013-R/6-W) Materiale:policarbonato, colore:Bianco .	Code <u>81078</u>
		Coprifilo - Copertura per giunto X bianco (S-9017-R/6-W) Materiale:policarbonato, colore:Bianco .	Code <u>81081</u>
		Coprifilo - Copertura per testata ad incasso nera (S-9001-R/6-B) Materiale:policarbonato, colore:Black.	Code <u>81070</u>
		Coprifilo - Copertura per giunto ad incasso nero (S-9010-R/6-B) Materiale:policarbonato, colore:Black.	Code <u>81073</u>
		Coprifilo Materiale:policarbonato, colore:Black.	Code <u>81076</u>

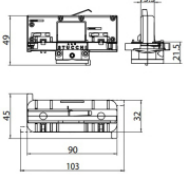
Optus_Ww | Projectors | Accessories
83923N07

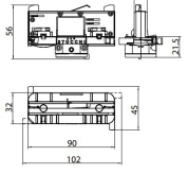
		<p>Coprifilo - Copertura per giunti T incassato nero (S-9013-R/6-B) Materiale:policarbonato, colore:Black.</p>	<p>Code <u>81079</u></p>
		<p>Coprifilo - Copertura per giunto X incassato nero (S-9017-R/6-B) Materiale:policarbonato, colore:Black.</p>	<p>Code <u>81082</u></p>
		<p>Coprifilo Materiale:Bianco .</p>	<p>Code <u>83249</u></p>
		<p>Coprifilo Materiale:Nero , colore:Black.</p>	<p>Code <u>83250</u></p>
		<p>Adattatore trifase/DALI bianco (9009/W)</p>	<p>Code <u>81094</u></p>
		<p>Adattatore trifase bianco (9009-4/W)</p>	<p>Code <u>81091</u></p>
		<p>Adattatore trifase/DALI nero (9009/B)</p>	<p>Code <u>81095</u></p>
		<p>adattatore trifase nero (9009-4/B)</p>	<p>Code <u>81093</u></p>

	<p>Utensile - Tronchese S-9000/T Materiale:gomma, colore:Black.</p>	<p>Code <u>81005</u></p>
 	<p>Binario - Binario Incassato Trifase DALI Bianco, 1 m (9000-1/W-R) Lunghezza: 1000mm; Tipo binario: Standard. Materiale:alluminio, colore:Text white (R9003), lavorazione:verniciatura.</p>	<p>Code <u>80990</u></p>
 	<p>Binario - Binario Incassato Trifase DALI Bianco, 2 m (9000-2/W-R) Lunghezza: 2000mm; Tipo binario: Standard. Materiale:alluminio, colore:Text white (R9003), lavorazione:verniciatura.</p>	<p>Code <u>80991</u></p>
 	<p>Binario - Binario Incassato Trifase DALI Bianco, 3 m (9000-3/W-R) Lunghezza: 3000mm; Tipo binario: Standard. Materiale:alluminio, colore:Text white (R9003), lavorazione:verniciatura.</p>	<p>Code <u>80992</u></p>
 	<p>Binario - Binario Incassato Trifase DALI Nero, 1 m (9000-1/B-R) Lunghezza: 1000mm; Tipo binario: Standard. Materiale:alluminio, colore:Text black (R9005), lavorazione:verniciatura.</p>	<p>Code <u>80993</u></p>
 	<p>Binario - Binario Incassato Trifase DALI Nero, 2 m (9000-2/B-R) Lunghezza: 2000mm; Tipo binario: Standard. Materiale:alluminio, colore:Text black (R9005), lavorazione:verniciatura.</p>	<p>Code <u>80994</u></p>
 	<p>Binario - Binario Incassato Trifase DALI Nero, 3 m (9000-3/B-R) Lunghezza: 3000mm; Tipo binario: Standard. Materiale:alluminio, colore:Text black (R9005), lavorazione:verniciatura.</p>	<p>Code <u>80995</u></p>
 	<p>Binario Lunghezza: 1000mm; Tipo binario: Standard. Materiale:alluminio, colore:Text white (R9003), lavorazione:verniciatura.</p>	<p>Code <u>83336</u></p>

Optus_Ww | Projectors | Accessories
83923N07

		<p>Binario Lunghezza: 2000mm; Tipo binario: Standard. Materiale:alluminio, colore:Text white (R9003), lavorazione:verniciatura.</p>	<p>Code <u>83337</u></p>
		<p>Binario Lunghezza: 3000mm; Tipo binario: Standard. Materiale:alluminio, colore:Text white (R9003), lavorazione:verniciatura.</p>	<p>Code <u>83338</u></p>
		<p>Binario Lunghezza: 1000mm; Tipo binario: Standard. Materiale:alluminio, colore:Text black (R9005), lavorazione:verniciatura.</p>	<p>Code <u>83339</u></p>
		<p>Binario Lunghezza: 2000mm; Tipo binario: Standard. Materiale:alluminio, colore:Text black (R9005), lavorazione:verniciatura.</p>	<p>Code <u>83340</u></p>
		<p>Binario Lunghezza: 3000mm; Tipo binario: Standard. Materiale:alluminio, colore:Text black (R9005), lavorazione:verniciatura.</p>	<p>Code <u>83341</u></p>

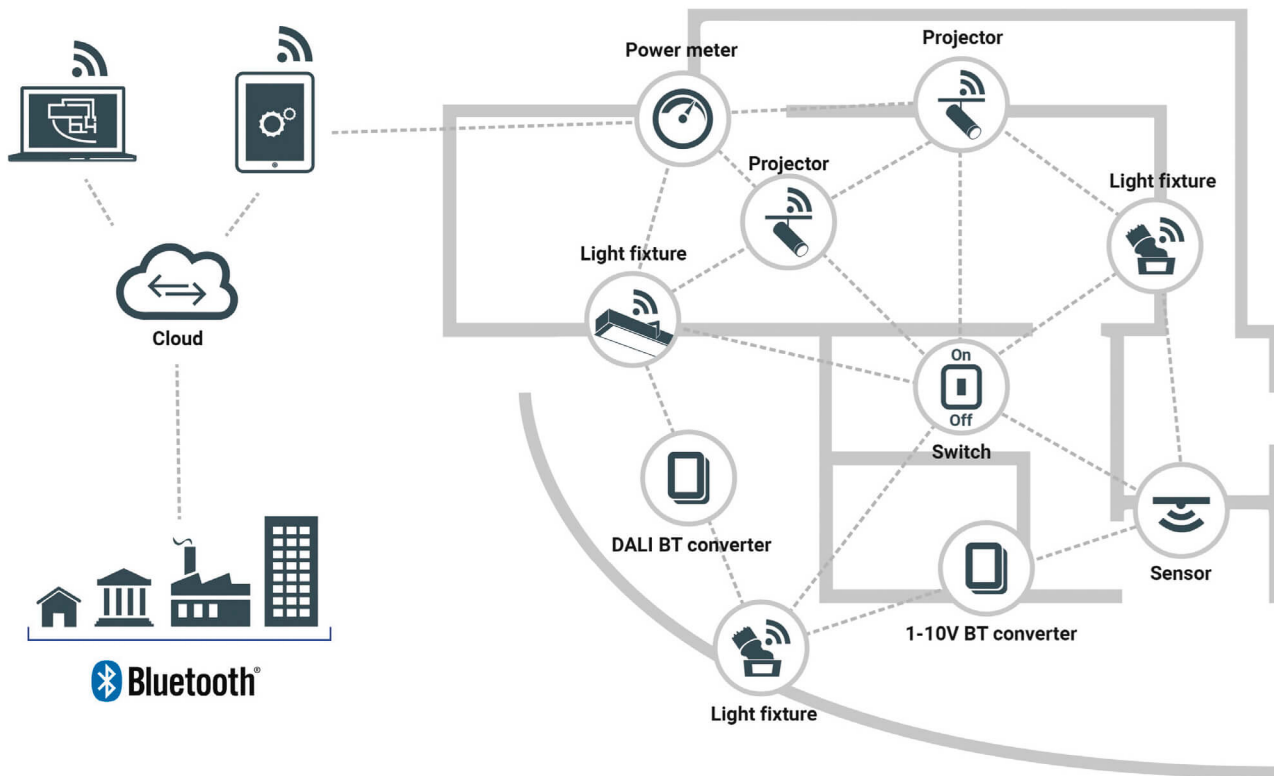

Identificazione dispositivo

Alla prima accensione del dispositivo e ogni volta che viene effettuato il reset, il sistema effettua l'identificazione della lampada. L'identificazione consiste in un'animazione definita "Attention event" con il 40% di luminosità per 500ms, 100% di luminosità per 500 ms. Anche il LED blu di stato effettua un lampeggio durante la fase di identificazione con 500ms ON/500ms OFF.

Ripristino delle impostazioni di fabbrica del dispositivo

Bluetooth – Factory reset for Bluetooth device Un ripristino delle impostazioni di fabbrica cambierà lo stato del modulo nella rete mesh da connesso a non connesso, ovvero tutte le impostazioni di rete andranno perse. Questa funzionalità è necessaria per ripristinare la connessione di un dispositivo dopo un comportamento imprevisto in cui si perde il controllo del dispositivo. Per effettuare il ripristino alle impostazioni di fabbrica dell'apparecchiatura Bluetooth è sufficiente portare a contatto un magnete al simbolo indicato nell'involucro contenente il modulo Bluetooth. Mettere a contatto il magnete per 5 secondi. Una volta effettuato il ripristino alle impostazioni di fabbrica, il sistema effettuerà un'identificazione del dispositivo.



Antenna

L'antenna è incorporata all'interno dell'articolo.

Lampeggio del LED

Il LED blu di stato posizionato nell'involucro contenente l'interfaccia Bluetooth effettua una serie di lampeggi a seconda dello stato in cui la lampada si trova.

Lampeggio veloce / lampeggio lento

Il LED effettua un lampeggio veloce se la lampada non è connessa alla rete (ogni 300ms) Il LED effettua un lampeggio lento se la lampada è connessa alla rete (ogni 2s)

Lampada non connessa



Lampada connessa



Lampeggio durante il reset alle impostazioni di fabbrica

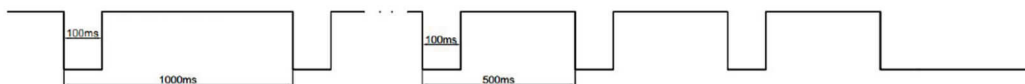

Ricevimento di un pacchetto mesh



Altre informazioni

- La portata wireless potrebbe essere influenzata, in modo particolare dalle superfici metalliche. In queste condizioni la portata wireless deve essere verificata.
- Se il dispositivo non è connesso ad una rete ci vorranno circa 30 secondi perché sia visualizzato come dispositivo disponibile dopo essere stato acceso.
- Il dispositivo ha superato con successo il processo di test SILVAIR
- Supporta gli switch EnOcean 83017
- Supporta i sensori Murata 83016
- Lo strumento può essere messo in funzione attraverso l'applicazione di messa in servizio SILVAR presente nell'app store del proprio smartphone o tablet.
- Per ulteriori informazioni consultare la guida SILVAIR al seguente link: <https://silvair.com/resources/product-documents/>
- Linea Light non avrà alcuna responsabilità per qualsiasi strumento di messa in servizio di terze parti e non fornisce alcuna dichiarazione, espressa o implicita, sulla disponibilità e / o sulle prestazioni di tale strumento di messa in servizio.

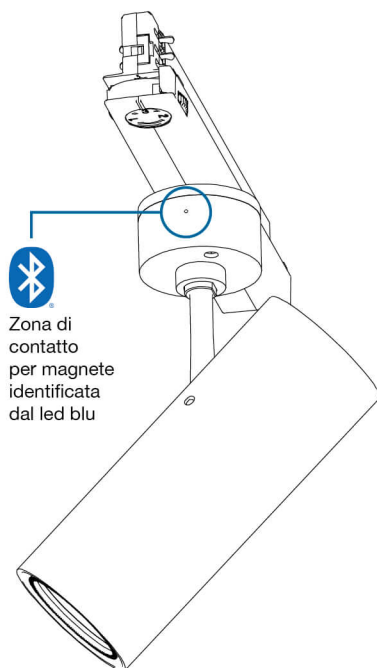
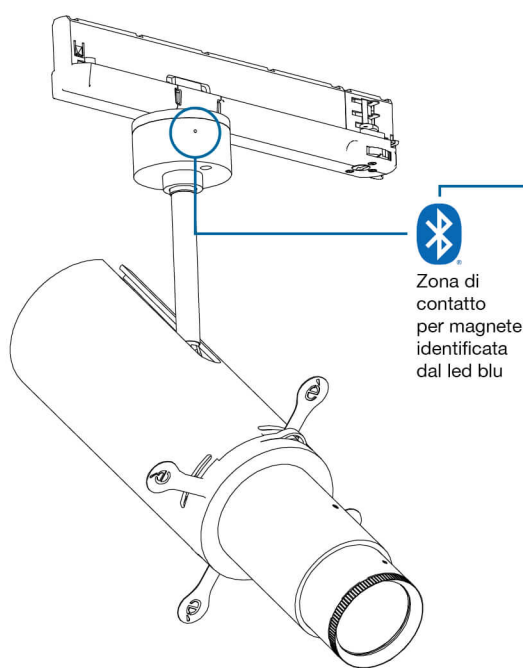
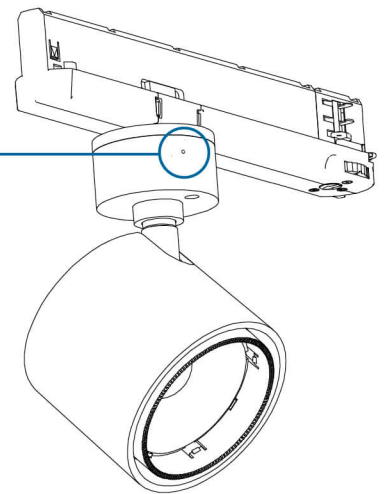
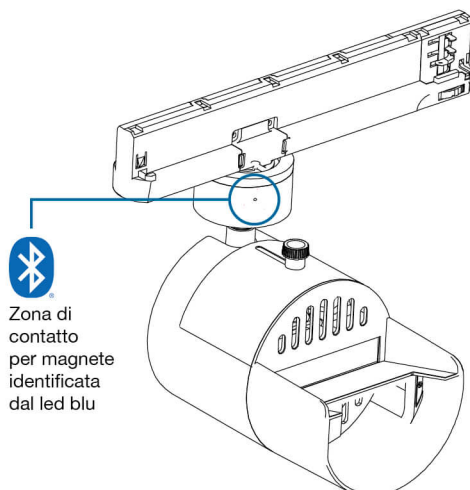
**POUND_T
POUND FOCUS****POUND SHAPER****OPTUS_T****OPTUS_Ww****Base
NAVATA OPTUS
NAVATA POUND
SHAPER**