

Proiettori | 198-264 V  
8 x powerLEDs 17 W DC - 19 W AC | CRI 90  
**83921W07**

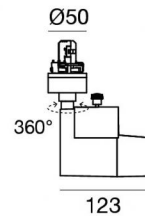
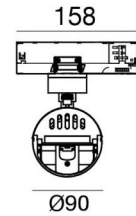

Dati tecnici	
Tipologia	Binario
Posizione installativa	Soffitto
Ambiente installativo	Indoor
Sorgente luminosa	Tecnologia LED
Struttura del circuito	powerLEDs
Ottica	Adjustable Wall Washer
Direzione emissione luminosa	frontale
Potenza nominale	17 W DC
Potenza totale	19 W
Flusso luminoso sorgente	2174 lm
Tensione nominale di ingresso	220 - 240 V AC
Range di tensione in ingresso	198 - 264 V AC
Frequenza	50 - 60 Hz
CCT / Tonalità	3000 K
Indice di resa cromatica	90 Ra
C.C. / C.V.	AC
Classe di isolamento	2
IP	IP20
Prova del filo incandescente	850°
Montaggio diretto su superfici normalmente infiammabili	Si
CE	Si
Driver incluso	Driver
Articolo dimmerabile	Bluetooth
Orientabilità	Orientabile
angolo totale (piano verticale)	90 °
angolo totale (piano orizzontale)	360 °
Basculante	No
Calpestabilità	No
Carrabilità	No
Cavo incluso	No
Resinatura	No
Tipologia di emissione luminosa	Singola emissione
Peso netto	0.825 Kg
Protezione scariche elettrostatiche	Si
Protezione surge	2 KV

Finitura Finitura corpo	
Materiale	Alluminio Pressofuso EN AB - 46100
Colore	Text white (R9003)
Lavorazione	Verniciatura a polvere termoidurente

Technology Partner  
**SILVAIR**

Proiettori | 198-264 V | 8 x powerLEDs 17 W DC - 19 W AC | CRI 90 | Chiuso  
**83921W07**

Proiettori a singola emissione per applicazione indoor. La sorgente luminosa LED, di colore bianco caldo, con distribuzione luminosa Adjustable Wall Washer, è composta da 8 LED powered, con una CCT 3000 K ed un CRI 90; il flusso luminoso della sorgente è di 2174 lm, con un'efficienza nominale di 127.9 lm/W.

Il corpo dell'apparecchio, realizzato in alluminio pressofuso en ab - 46100, presenta una finitura di colore text white (r9003), ottenuta tramite verniciatura a polvere termoidurente.

Il grado di protezione è IP20; il peso complessivo è di 0.825 kg.

La potenza assorbita dall'apparecchio è di 19 W

L'apparecchio presenta una classe di isolamento II ed è installabile a soffitto.

Conforme alla norma EN 60598-1 e alle relative prescrizioni particolari.

**Classe di efficienza energetica**

Questo prodotto contiene una sorgente luminosa di classe di efficienza energetica F.

**Caratteristiche Illuminotecniche**

Resa luminosa apparecchio (LOR)	33 %
Flusso luminoso sorgente	2174 lm
Flusso luminoso apparecchio	730 lm
Potenza reale apparecchio	19 W
Efficienza reale apparecchio	38 lm/W
Temperatura di colore	3000 K
Deviazione standard di corrispondenza colore	3 Step MacAdam
Indice di resa cromatica	90 Ra
Temperatura standard dell'ambiente di esercizio	-20 / +50°C
Temperatura tipica sul vetro	40°C

**LED Life / Failure Ratio**

L70 B10 C0 363000h (at Tj 65 Ta 25 )

L80 B10 C0 237566h (at Tj 65 Ta 25 )

L90 B10 C0 151000h (at Tj 65 Ta 25 )

**OPTICAL**

Ottica C0/C180	57°
Light distribution simmetry	Asymmetrical

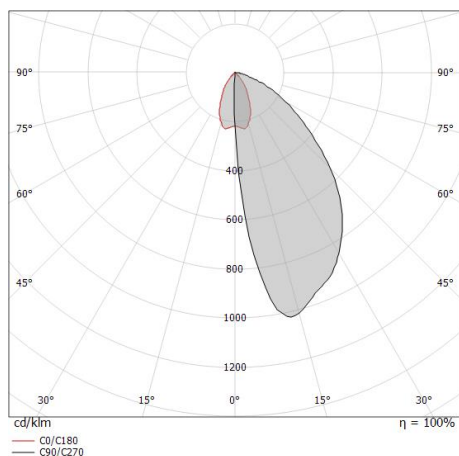

Distance [m]	Cone diameter [m]	Illuminance [lx]
0.5	0.55	E(0°) 631 E(C0) 228
1.0	1.09	E(0°) 158 E(C0) 57
1.5	1.64	E(0°) 70 E(C0) 25
2.0	2.19	E(0°) 39 E(C0) 14
2.5	2.74	E(0°) 25 E(C0) 9
3.0	3.28	E(0°) 18 E(C0) 6

Distance [m] Cone diameter [m] Illuminance [lx]  
 — C0/C180 (Half-peak divergence: 57.4°)

Proiettori | 198-264 V | 8 x powerLEDs 17 W DC - 19 W AC | CRI 90 | Aperto

**83921W07**

Proiettori a singola emissione per applicazione indoor. La sorgente luminosa LED, di colore bianco caldo, con distribuzione luminosa Adjustable Wall Washer, è composta da 8 LED powered, con una CCT 3000 K ed un CRI 90; il flusso luminoso della sorgente è di 2174 lm, con un'efficienza nominale di 127.9 lm/W.

Il corpo dell'apparecchio, realizzato in alluminio pressofuso en ab - 46100, presenta una finitura di colore text white (r9003), ottenuta tramite verniciatura a polvere termoidurente.

Il grado di protezione è IP20; il peso complessivo è di 0.825 kg.

La potenza assorbita dall'apparecchio è di 19 W

L'apparecchio presenta una classe di isolamento II ed è installabile a soffitto.

Conforme alla norma EN 60598-1 e alle relative prescrizioni particolari.

**Classe di efficienza energetica**

Questo prodotto contiene una sorgente luminosa di classe di efficienza energetica F.

**Caratteristiche Illuminotecniche**

Resa luminosa apparecchio (LOR)	44 %
Flusso luminoso sorgente	2174 lm
Flusso luminoso apparecchio	972 lm
Potenza reale apparecchio	19 W
Efficienza reale apparecchio	51 lm/W
Temperatura di colore	3000 K
Deviazione standard di corrispondenza colore	3 Step MacAdam
Indice di resa cromatica	90 Ra
Temperatura standard dell'ambiente di esercizio	-20 / +50°C
Temperatura tipica sul vetro	40°C

**LED Life / Failure Ratio**

L70 B10 C0 363000h (at Tj 65 Ta 25 )

L80 B10 C0 237566h (at Tj 65 Ta 25 )

L90 B10 C0 151000h (at Tj 65 Ta 25 )

**OPTICAL**

Ottica C0/C180	56°
Light distribution simmetry	Asymmetrical

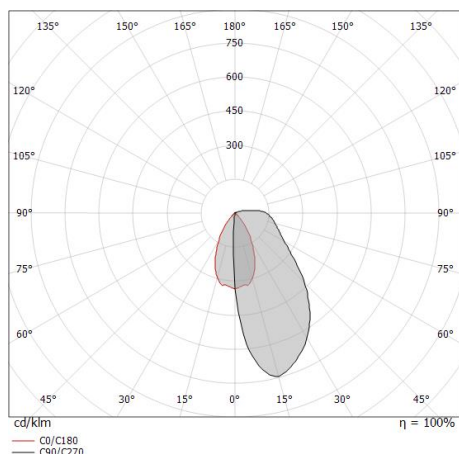

0.5	0.53	E(0°) E(C0)	28.0°	1299 448
1.0	1.06	E(0°) E(C0)	28.0°	325 112
1.5	1.60	E(0°) E(C0)	28.0°	144 50
2.0	2.13	E(0°) E(C0)	28.0°	81 28
2.5	2.66	E(0°) E(C0)	28.0°	52 18
3.0	3.19	E(0°) E(C0)	28.0°	36 12

Distance [m]      Cone diameter [m]      Illuminance [lx]

— C0/C180 (Half-peak divergence: 56.0°)

Optus\_Ww | Projectors | Accessories  
83921W07

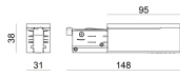

Power Supply - Testata di alimentazione destra bianca (9001/W)  
Materiale:policarbonato, colore:Bianco .

**Code**  
81033

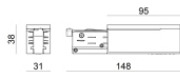

Power Supply - Testata di alimentazione sinistra bianca (9002/W)  
Materiale:policarbonato, colore:Bianco .

**Code**  
81036

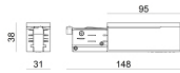

Power Supply - Testata di alimentazione sinistra nera (9002/B)  
Materiale:policarbonato, colore:Black.

**Code**  
81037

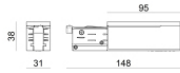

Power Supply - Testata di alimentazione destra nera (9001/B)  
Materiale:policarbonato, colore:Black.

**Code**  
81034



Tappo - Tappo di chiusura bianco 9004/W  
Materiale:policarbonato, colore:Bianco .

**Code**  
80999



Tappo - Tappo di chiusura nero 9004/B  
Materiale:policarbonato, colore:Black.

**Code**  
81000



Tappo - Tappo di chiusura bianco per incasso 9004-R/W  
Materiale:policarbonato, colore:Bianco .

**Code**  
81002

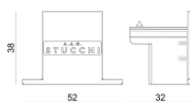

Tappo - Tappo di chiusura nero per incasso 9004-R/B  
Materiale:policarbonato, colore:Black.

**Code**  
81003

Optus\_Ww | Projectors | Accessories  
83921W07

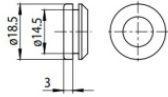

Tappo - Guarnizione bianca (S-9001/115-W)  
Materiale:Bianco .

**Code**  
81084

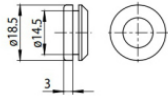

Tappo - Guarnizione nera (S-9001/115-B)  
Materiale:Nero , colore:Black.

**Code**  
81085



Rosone - Kit sospensione bianco 1.5m + staffa (9000-KIT5-1,5-W)  
Driver incluso: No.  
Materiale:plastica, colore:Bianco .

**Code**  
81012

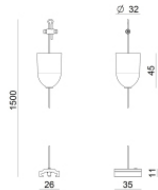

Rosone - Kit sospensione nero 1.5m + staffa (9000-KIT5-1,5-B)  
Driver incluso: No.  
Materiale:plastica, colore:Black.

**Code**  
81014

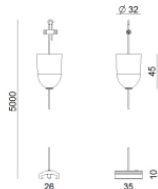

Rosone - Kit sospensione bianco 5m + staffa (9000-KIT5-5-W)  
Driver incluso: No.  
Materiale:plastica, colore:Bianco .

**Code**  
81013



Rosone - Kit sospensione nero 5m + staffa (9000-KIT5-5-B)  
Driver incluso: No.  
Materiale:plastica, colore:Black.

**Code**  
81015



Staffa - Staffa anodizzata per fissaggio a soffitto (S-9000/131)  
L=35mm, H=14mm, D=24mm.  
Materiale:alluminio, colore:Polished aluminium.

**Code**  
81086



Staffa - Staffa anodizzata di irrigidimento (S-9000/333)  
L=180mm, H=24mm, D=26mm.  
Materiale:alluminio, colore:Anodised aluminium, lavorazione:anodizzazione.

**Code**  
81024

Optus\_Ww | Projectors | Accessories  
83921W07



Staffa - Staffa bianca di irrigidimento (S-9000/333-W)

L=180mm, H=24mm, D=20mm.

Materiale:alluminio, colore:Bianco RAL 9010, lavorazione:verniciatura.

**Code**

81025



Staffa - Staffa nera di irrigidimento (S-9000/333-B)

L=180mm, H=24mm, D=20mm.

Materiale:alluminio, colore:Nero RAL 9005, lavorazione:verniciatura.

**Code**

81026



Staffa - Staffa bianca per fissaggio a soffitto (S-9000/131-W)

L=35mm, H=14mm, D=24mm.

Materiale:alluminio, colore:Bianco , lavorazione:verniciatura.

**Code**

81087



Staffa - Staffa nera per fissaggio a soffitto (S-9000/131-B)

L=35mm, H=14mm, D=24mm.

Materiale:alluminio, colore:Text black (R9005), lavorazione:verniciatura.

**Code**

81088

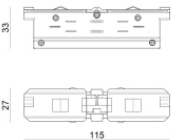

Giunzione - Giunto elettrico bianco - interno (9003/W)

Tipologia linear.

Materiale:policarbonato, colore:Bianco .

**Code**

81039

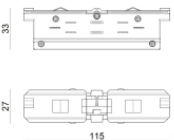

Giunzione - Giunto elettrico nero - interno (9003/B)

Tipologia linear.

Materiale:policarbonato, colore:Black.

**Code**

81040



Giunzione - Giunto di alimentazione bianco - centrale (9010/W)

Tipologia linear.

Materiale:policarbonato, colore:Bianco .

**Code**

81042

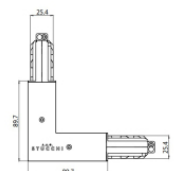

Giunzione - Giunto a L bianco - interno (9011/W)

Tipologia linear.

Materiale:policarbonato, colore:Bianco .



**Code**

81045

Optus\_Ww | Projectors | Accessories  
83921W07

		<p>Giunzione - Giunto a L bianco - esterno (9012/W)</p> <p>Tipologia linear.</p> <p>Materiale:policarbonato, colore:Bianco .</p>	<p><b>Code</b> <u>81048</u></p>
		<p>Giunzione - Giunto flessibile bianco (9018/W)</p> <p>Tipologia flexible curve.</p> <p>Materiale:policarbonato, colore:Bianco .</p>	<p><b>Code</b> <u>81066</u></p>
		<p>Giunzione - Giunto a X bianco (9017/W)</p> <p>Tipologia linear.</p> <p>Materiale:policarbonato, colore:Bianco .</p>	<p><b>Code</b> <u>81063</u></p>
		<p>Giunzione - Giunto a T sinistro bianco - esterno (9013/W)</p> <p>Tipologia linear.</p> <p>Materiale:policarbonato, colore:Bianco .</p>	<p><b>Code</b> <u>81051</u></p>
		<p>Giunzione - Giunto a T destro bianco - esterno (9014/W)</p> <p>Tipologia linear.</p> <p>Materiale:policarbonato, colore:Bianco .</p>	<p><b>Code</b> <u>81054</u></p>
		<p>Giunzione - Giunto a T bianco sinistro - interno (9015/W)</p> <p>Tipologia linear.</p> <p>Materiale:policarbonato, colore:Bianco .</p>	<p><b>Code</b> <u>81057</u></p>
		<p>Giunzione - Giunto a T bianco destro - interno (9016/W)</p> <p>Tipologia linear.</p> <p>Materiale:policarbonato, colore:Bianco .</p>	<p><b>Code</b> <u>81060</u></p>
		<p>Giunzione - Giunto di alimentazione nero - centrale (9010/B)</p> <p>Tipologia linear.</p> <p>Materiale:policarbonato, colore:Black.</p>	<p><b>Code</b> <u>81043</u></p>

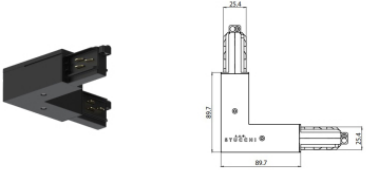
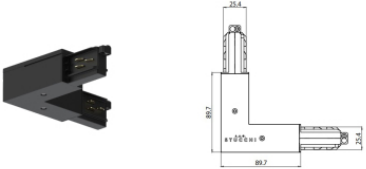
Optus\_Ww | Projectors | Accessories  
83921W07

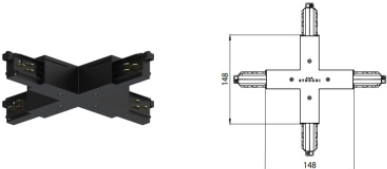
	<p>Giunzione - Giunto a L nero - interno (9011/B) Tipologia linear. Materiale:policarbonato, colore:Black.</p>	<p><b>Code</b> <u>81046</u></p>
	<p>Giunzione - Giunto a L nero - esterno (9012/B) Tipologia linear. Materiale:policarbonato, colore:Black.</p>	<p><b>Code</b> <u>81049</u></p>
	<p>Giunzione - Giunto flessibile nero (9018/B) Tipologia flexible curve. Materiale:policarbonato, colore:Black.</p>	<p><b>Code</b> <u>81067</u></p>
	<p>Giunzione - Giunto a X nero (9017/B) Tipologia linear. Materiale:policarbonato, colore:Black.</p>	<p><b>Code</b> <u>81064</u></p>
	<p>Giunzione - Giunto a T sinistro nero - esterno (9013/B) Tipologia linear. Materiale:policarbonato, colore:Black.</p>	<p><b>Code</b> <u>81052</u></p>
	<p>Giunzione - Giunto a T destro nero - esterno (9014/B) Tipologia linear. Materiale:policarbonato, colore:Black.</p>	<p><b>Code</b> <u>81055</u></p>
	<p>Giunzione - Giunto a T nero sinistro - interno (9015/B) Tipologia linear. Materiale:policarbonato, colore:Black.</p>	<p><b>Code</b> <u>81058</u></p>
	<p>Giunzione - Giunto a T destro nero - interno (9016/B) Tipologia linear. Materiale:policarbonato, colore:Black.</p>	<p><b>Code</b> <u>81061</u></p>

Optus\_Ww | Projectors | Accessories  
83921W07



Sospensioni - Kit sospensione bianco 1.5m (9000-KIT3-1,5-W)  
Materiale:plastica, colore:Bianco .

**Code**  
81006



Sospensioni - Kit sospensione bianco 5m (9000-KIT3-5-W)  
Materiale:plastica, colore:Bianco .

**Code**  
81007

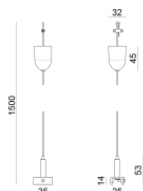

Sospensioni - Kit sospensione nero 1.5m (9000-KIT3-1,5-B)  
Materiale:plastica, colore:Black.

**Code**  
81008

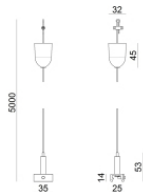

Sospensioni - Kit sospensione nero 5m (9000-KIT3-5-B)  
Materiale:plastica, colore:Black.

**Code**  
81009



Sospensioni - Clip per sospensione rigida bianca (S-9000-P2-W)  
Materiale:plastica, colore:Bianco .

**Code**  
81018



Sospensioni - Clip per sospensione rigida nera (S-9000-P2-B)  
Materiale:plastica, colore:Black.

**Code**  
81019



Sospensioni - Sospensione rigida 1m bianca (S-9000-P3-W)  
Materiale:plastica, colore:Bianco .

**Code**  
81021











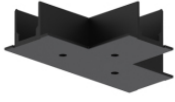
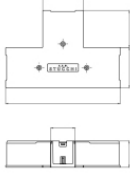
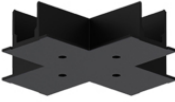
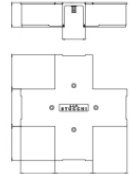

Sospensioni - Sospensione rigida 1m nera (S-9000-P3-B)  
Materiale:plastica, colore:Black.

**Code**  
81022

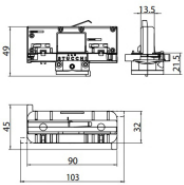
Optus\_Ww | Projectors | Accessories  
83921W07

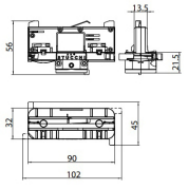
		Coprifilo - Copertura per testata ad incasso bianca (S-9001-R/6-W) Materiale:policarbonato, colore:Bianco .	<b>Code</b> <u>81069</u>
		Coprifilo - Copertura per giunto ad incasso bianco (S-9010-R/6-W) Materiale:policarbonato, colore:Bianco .	<b>Code</b> <u>81072</u>
		Coprifilo - Copertura per giunto L incassato bianco (S-9011-R/6-W) Materiale:policarbonato, colore:Bianco .	<b>Code</b> <u>81075</u>
		Coprifilo - Coperture per giunto T incassato bianco (S-9013-R/6-W) Materiale:policarbonato, colore:Bianco .	<b>Code</b> <u>81078</u>
		Coprifilo - Copertura per giunto X bianco (S-9017-R/6-W) Materiale:policarbonato, colore:Bianco .	<b>Code</b> <u>81081</u>
		Coprifilo - Copertura per testata ad incasso nera (S-9001-R/6-B) Materiale:policarbonato, colore:Black.	<b>Code</b> <u>81070</u>
		Coprifilo - Copertura per giunto ad incasso nero (S-9010-R/6-B) Materiale:policarbonato, colore:Black.	<b>Code</b> <u>81073</u>
		Coprifilo Materiale:policarbonato, colore:Black.	<b>Code</b> <u>81076</u>

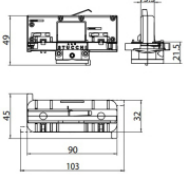
Optus\_Ww | Projectors | Accessories  
83921W07

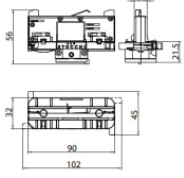
		<p>Coprifilo - Copertura per giunti T incassato nero (S-9013-R/6-B) Materiale:policarbonato, colore:Black.</p>	<p><b>Code</b> <u>81079</u></p>
		<p>Coprifilo - Copertura per giunto X incassato nero (S-9017-R/6-B) Materiale:policarbonato, colore:Black.</p>	<p><b>Code</b> <u>81082</u></p>
		<p>Coprifilo Materiale:Bianco .</p>	<p><b>Code</b> <u>83249</u></p>
		<p>Coprifilo Materiale:Nero , colore:Black.</p>	<p><b>Code</b> <u>83250</u></p>
		<p>Adattatore trifase/DALI bianco (9009/W)</p>	<p><b>Code</b> <u>81094</u></p>
		<p>Adattatore trifase bianco (9009-4/W)</p>	<p><b>Code</b> <u>81091</u></p>
		<p>Adattatore trifase/DALI nero (9009/B)</p>	<p><b>Code</b> <u>81095</u></p>
		<p>adattatore trifase nero (9009-4/B)</p>	<p><b>Code</b> <u>81093</u></p>

Optus\_Ww | Projectors | Accessories  
83921W07

	<p>Utensile - Tronchese S-9000/T Materiale:gomma, colore:Black.</p>	<p><b>Code</b> <u>81005</u></p>
	<p>Binario - Binario Incassato Trifase DALI Bianco, 1 m (9000-1/W-R) Lunghezza: 1000mm; Tipo binario: Standard. Materiale:alluminio, colore:Text white (R9003), lavorazione:verniciatura.</p>	<p><b>Code</b> <u>80990</u></p>
	<p>Binario - Binario Incassato Trifase DALI Bianco, 2 m (9000-2/W-R) Lunghezza: 2000mm; Tipo binario: Standard. Materiale:alluminio, colore:Text white (R9003), lavorazione:verniciatura.</p>	<p><b>Code</b> <u>80991</u></p>
	<p>Binario - Binario Incassato Trifase DALI Bianco, 3 m ( 9000-3/W-R) Lunghezza: 3000mm; Tipo binario: Standard. Materiale:alluminio, colore:Text white (R9003), lavorazione:verniciatura.</p>	<p><b>Code</b> <u>80992</u></p>
	<p>Binario - Binario Incassato Trifase DALI Nero, 1 m (9000-1/B-R) Lunghezza: 1000mm; Tipo binario: Standard. Materiale:alluminio, colore:Text black (R9005), lavorazione:verniciatura.</p>	<p><b>Code</b> <u>80993</u></p>
	<p>Binario - Binario Incassato Trifase DALI Nero, 2 m (9000-2/B-R) Lunghezza: 2000mm; Tipo binario: Standard. Materiale:alluminio, colore:Text black (R9005), lavorazione:verniciatura.</p>	<p><b>Code</b> <u>80994</u></p>
	<p>Binario - Binario Incassato Trifase DALI Nero, 3 m (9000-3/B-R) Lunghezza: 3000mm; Tipo binario: Standard. Materiale:alluminio, colore:Text black (R9005), lavorazione:verniciatura.</p>	<p><b>Code</b> <u>80995</u></p>
	<p>Binario Lunghezza: 1000mm; Tipo binario: Standard. Materiale:alluminio, colore:Text white (R9003), lavorazione:verniciatura.</p>	<p><b>Code</b> <u>83336</u></p>

Optus\_Ww | Projectors | Accessories  
83921W07

		<p><b>Binario</b> Lunghezza: 2000mm; Tipo binario: Standard. Materiale:alluminio, colore:Text white (R9003), lavorazione:verniciatura.</p>	<p><b>Code</b> <u>83337</u></p>
		<p><b>Binario</b> Lunghezza: 3000mm; Tipo binario: Standard. Materiale:alluminio, colore:Text white (R9003), lavorazione:verniciatura.</p>	<p><b>Code</b> <u>83338</u></p>
		<p><b>Binario</b> Lunghezza: 1000mm; Tipo binario: Standard. Materiale:alluminio, colore:Text black (R9005), lavorazione:verniciatura.</p>	<p><b>Code</b> <u>83339</u></p>
		<p><b>Binario</b> Lunghezza: 2000mm; Tipo binario: Standard. Materiale:alluminio, colore:Text black (R9005), lavorazione:verniciatura.</p>	<p><b>Code</b> <u>83340</u></p>
		<p><b>Binario</b> Lunghezza: 3000mm; Tipo binario: Standard. Materiale:alluminio, colore:Text black (R9005), lavorazione:verniciatura.</p>	<p><b>Code</b> <u>83341</u></p>

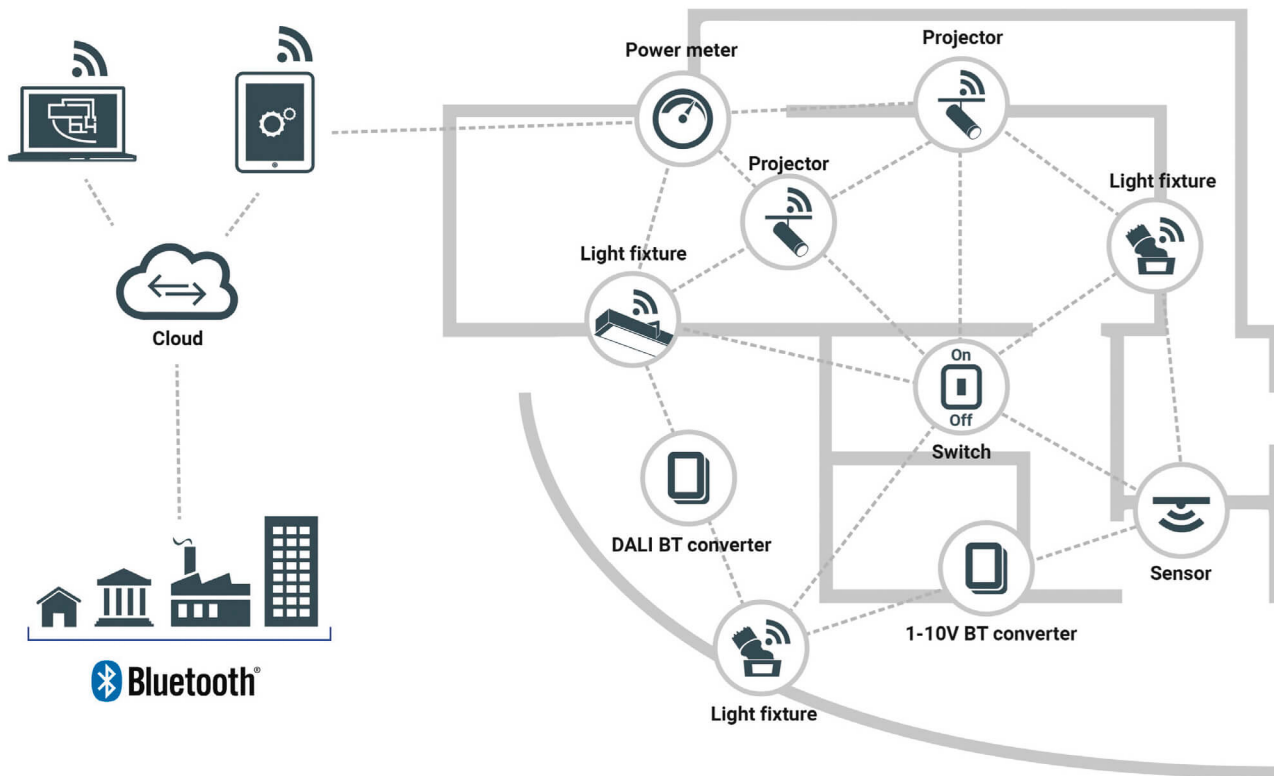

**Identificazione dispositivo**

Alla prima accensione del dispositivo e ogni volta che viene effettuato il reset, il sistema effettua l'identificazione della lampada. L'identificazione consiste in un'animazione definita "Attention event" con il 40% di luminosità per 500ms, 100% di luminosità per 500 ms. Anche il LED blu di stato effettua un lampeggio durante la fase di identificazione con 500ms ON/500ms OFF.

**Ripristino delle impostazioni di fabbrica del dispositivo**

Bluetooth – Factory reset for Bluetooth device Un ripristino delle impostazioni di fabbrica cambierà lo stato del modulo nella rete mesh da connesso a non connesso, ovvero tutte le impostazioni di rete andranno perse. Questa funzionalità è necessaria per ripristinare la connessione di un dispositivo dopo un comportamento imprevisto in cui si perde il controllo del dispositivo. Per effettuare il ripristino alle impostazioni di fabbrica dell'apparecchiatura Bluetooth è sufficiente portare a contatto un magnete al simbolo indicato nell'involucro contenente il modulo Bluetooth. Mettere a contatto il magnete per 5 secondi. Una volta effettuato il ripristino alle impostazioni di fabbrica, il sistema effettuerà un'identificazione del dispositivo.



**Antenna**

L'antenna è incorporata all'interno dell'articolo.

**Lampeggio del LED**

Il LED blu di stato posizionato nell'involucro contenente l'interfaccia Bluetooth effettua una serie di lampeggi a seconda dello stato in cui la lampada si trova.

**Lampeggio veloce / lampeggio lento**

Il LED effettua un lampeggio veloce se la lampada non è connessa alla rete (ogni 300ms) Il LED effettua un lampeggio lento se la lampada è connessa alla rete (ogni 2s)

**Lampada non connessa**



**Lampada connessa**



**Lampeggio durante il reset alle impostazioni di fabbrica**

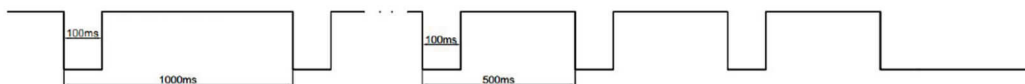

**Ricevimento di un pacchetto mesh**



**Altre informazioni**

- La portata wireless potrebbe essere influenzata, in modo particolare dalle superfici metalliche. In queste condizioni la portata wireless deve essere verificata.
- Se il dispositivo non è connesso ad una rete ci vorranno circa 30 secondi perché sia visualizzato come dispositivo disponibile dopo essere stato acceso.
- Il dispositivo ha superato con successo il processo di test SILVAIR
- Supporta gli switch EnOcean 83017
- Supporta i sensori Murata 83016
- Lo strumento può essere messo in funzione attraverso l'applicazione di messa in servizio SILVAR presente nell'app store del proprio smartphone o tablet.
- Per ulteriori informazioni consultare la guida SILVAIR al seguente link: <https://silvair.com/resources/product-documents/>
- Linea Light non avrà alcuna responsabilità per qualsiasi strumento di messa in servizio di terze parti e non fornisce alcuna dichiarazione, espressa o implicita, sulla disponibilità e / o sulle prestazioni di tale strumento di messa in servizio.

**POUND\_T  
POUND FOCUS**

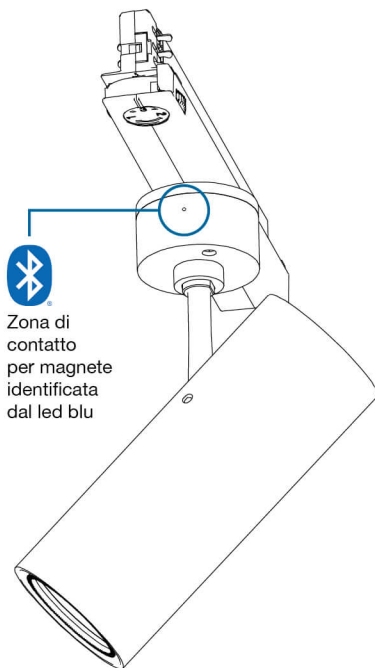

**POUND SHAPER**

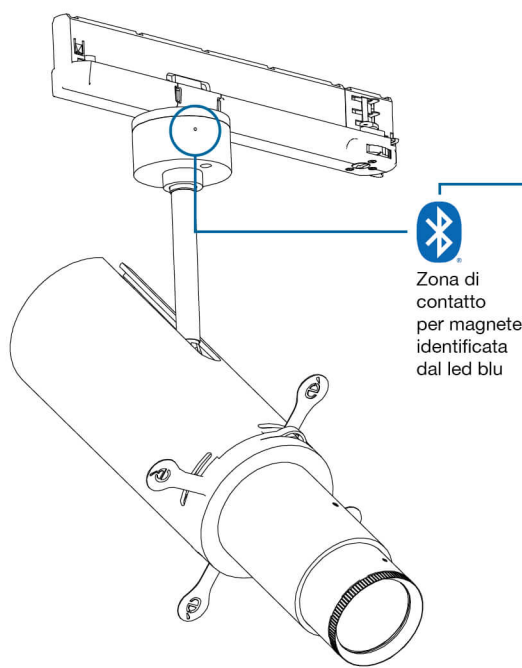

**OPTUS\_T**

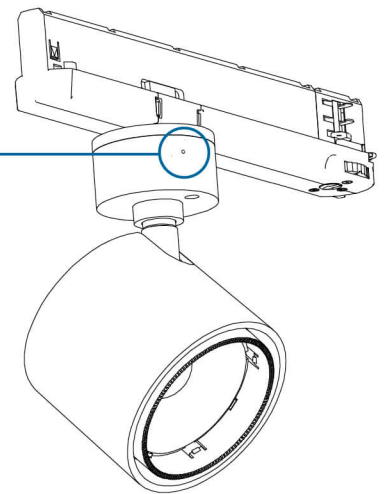

**OPTUS\_Ww**

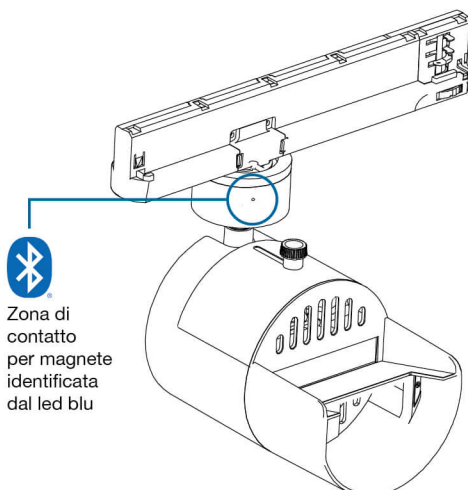

Base  
**NAVATA OPTUS  
NAVATA POUND  
SHAPER**

