

Proiettori | 198-264 V
1 arrayLED 32.5 W DC - 37 W AC | CRI 90
83840W85

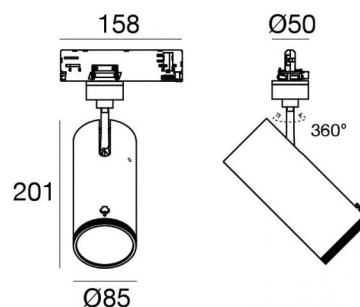

Dati tecnici	
Tipologia	Binario
Posizione installativa	Soffitto
Ambiente installativo	Indoor
Sorgente luminosa	Tecnologia LED
Struttura del circuito	arrayLED
Ottica	Adjustable Focus
Direzione emissione luminosa	frontale
Potenza nominale	32.5 W DC
Potenza totale	37 W
Flusso luminoso sorgente	4801 lm
Tensione nominale di ingresso	220 - 240 V AC
Range di tensione in ingresso	198 - 264 V AC
Frequenza	50 - 60 Hz
CCT / Tonalità	3000 K
Indice di resa cromatica	90 Ra
C.C. / C.V.	AC
Classe di isolamento	2
IP	IP20
Prova del filo incandescente	850°
Montaggio diretto su superfici normalmente infiammabili	Si
CE	Si
Driver incluso	Driver
Articolo dimmerabile	Bluetooth
Orientabilità	Orientabile
angolo totale (piano verticale)	90 °
angolo totale (piano orizzontale)	360 °
Basculante	No
Calpestabilità	No
Carrabilità	No
Cavo incluso	No
Resinatura	No
Tipologia di emissione luminosa	Singola emissione
Peso netto	0.92 Kg
Protezione scariche elettrostatiche	Si
Protezione surge	2 KV
Tecnologia ottica	Anti - Glare

Finitura Finitura corpo	
Materiale	Alluminio Pressofuso EN AB - 46100
Colore	Text black (R9005)
Lavorazione	Verniciatura a polvere termoidurente

Technology Partner

SILVAIR

Proiettori | 198-264 V | 1 arrayLED 32.5 W DC - 37 W AC | CRI 90 | Angolo Max 83840W85

Proiettori a singola emissione per applicazione indoor. La sorgente luminosa LED, di colore bianco caldo, con distribuzione luminosa Adjustable Focus, è composta da 1 LED arrayled, con una CCT 3000 K ed un CRI 90; il flusso luminoso della sorgente è di 4801 lm, con un'efficienza nominale di 147.7 lm/W.

Il corpo dell'apparecchio, realizzato in alluminio pressofuso en ab - 46100, presenta una finitura di colore text black (r9005), ottenuta tramite verniciatura a polvere termoindurente.

Il grado di protezione è IP20; il peso complessivo è di 0.92 kg.

La potenza assorbita dall'apparecchio è di 37 W

L'apparecchio presenta una classe di isolamento II ed è installabile a soffitto.

Conforme alla norma EN 60598-1 e alle relative prescrizioni particolari.

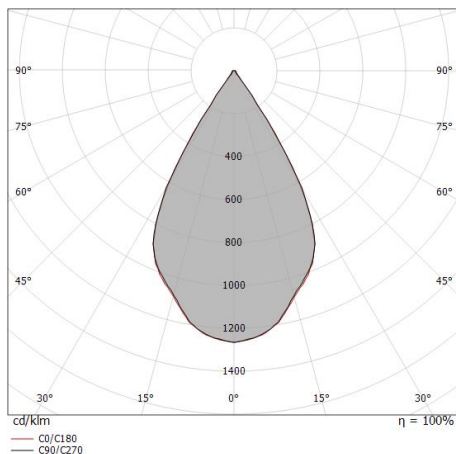

Distance [m]	Cone diameter [m]	illuminance [lx]
0.5	0.58 0.57	E(0°) 11724 E(C90) 29.9° 3833 E(C0) 29.7° 3867
1.0	1.15 1.14	E(0°) 2931 E(C90) 29.9° 958 E(C0) 29.7° 967
1.5	1.73 1.71	E(0°) 1303 E(C90) 29.9° 426 E(C0) 29.7° 430
2.0	2.30 2.28	E(0°) 733 E(C90) 29.9° 240 E(C0) 29.7° 242
2.5	2.88 2.85	E(0°) 469 E(C90) 29.9° 153 E(C0) 29.7° 155
3.0	3.45 3.42	E(0°) 326 E(C90) 29.9° 106 E(C0) 29.7° 107

— C0/C180 (Half-peak divergence: 59.4°)
— C90/C270 (Half-peak divergence: 59.8°)

Classe di efficienza energetica

Questo prodotto contiene una sorgente luminosa di classe di efficienza energetica D.

Caratteristiche Illuminotecniche

Resa luminosa apparecchio (LOR)	48 %
Flusso luminoso sorgente	4801 lm
Flusso luminoso apparecchio	2317 lm
Potenza reale apparecchio	37 W
Efficienza reale apparecchio	62 lm/W
Temperatura di colore	3000 K
Deviazione standard di corrispondenza colore	2 Step MacAdam
Indice di resa cromatica	90 Ra
Indice Resa Cromatica	60 R9
Black Body Locus	On
Temperatura standard dell'ambiente di esercizio	-20 / +50°C
Temperatura tipica sul vetro	40°C

LED Life / Failure Ratio

L70 B10 C0 235315h (at Tj 65 Ta 25)
L80 B10 C0 147343h (at Tj 65 Ta 25)
L90 B10 C0 69745h (at Tj 65 Ta 25)

UGR

UGR axial	20.9
UGR transversal	20.8
X=4H Y=8H	S=0.25H
Reflection factor	70/50/20

OPTICAL

Optica C0/C180	59°
Light distribution simmetry	Symmetrical

COLOR VECTOR GRAPHIC

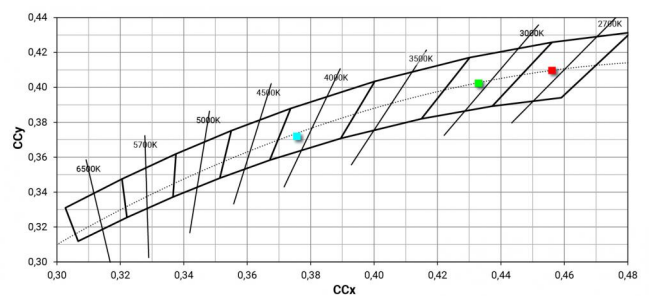
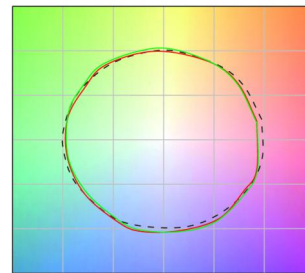

Proiettori | 198-264 V | 1 arrayLED 32.5 W DC - 37 W AC | CRI 90 | Angolo Min

83840W85

Proiettori a singola emissione per applicazione indoor. La sorgente luminosa LED, di colore bianco caldo, con distribuzione luminosa Adjustable Focus, è composta da 1 LED arrayled, con una CCT 3000 K ed un CRI 90; il flusso luminoso della sorgente è di 4801 lm, con un'efficienza nominale di 147.7 lm/W.

Il corpo dell'apparecchio, realizzato in alluminio pressofuso en ab - 46100, presenta una finitura di colore text black (r9005), ottenuta tramite verniciatura a polvere termoindurente.

Il grado di protezione è IP20; il peso complessivo è di 0.92 kg.

La potenza assorbita dall'apparecchio è di 37 W

L'apparecchio presenta una classe di isolamento II ed è installabile a soffitto.

Conforme alla norma EN 60598-1 e alle relative prescrizioni particolari.

Classe di efficienza energetica

Questo prodotto contiene una sorgente luminosa di classe di efficienza energetica D.

Caratteristiche Illuminotecniche

Resa luminosa apparecchio (LOR)	23 %
Flusso luminoso sorgente	4801 lm
Flusso luminoso apparecchio	1112 lm
Potenza reale apparecchio	37 W
Efficienza reale apparecchio	30 lm/W
Temperatura di colore	3000 K
Deviazione standard di corrispondenza colore	2 Step MacAdam
Indice di resa cromatica	90 Ra
Indice Resa Cromatica	60 R9
Black Body Locus	On
Temperatura standard dell'ambiente di esercizio	-20 / +50°C
Temperatura tipica sul vetro	40°C

LED Life / Failure Ratio

L70 B10 C0 235315h (at Tj 65 Ta 25)

L80 B10 C0 147343h (at Tj 65 Ta 25)

L90 B10 C0 69745h (at Tj 65 Ta 25)

UGR

UGR axial	11.5
UGR transversal	11.6
X=4H Y=8H	S=0.25H
Reflection factor	70/50/20

OPTICAL

Optica C0/C180	16°
Light distribution simmetry	Symmetrical

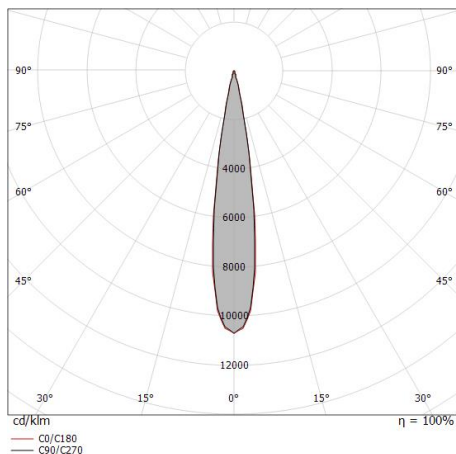

Distance [m]	Cone diameter [m]	illuminance [lx]
0.5	0.15 0.15	E(0°) 47602 E(C90) 8.2° 23573 E(C0) 8.5° 23096
1.0	0.29 0.30	E(0°) 11900 E(C90) 8.2° 5893 E(C0) 8.5° 5774
1.5	0.43 0.45	E(0°) 5289 E(C90) 8.2° 2819 E(C0) 8.5° 2566
2.0	0.58 0.60	E(0°) 2975 E(C90) 8.2° 1473 E(C0) 8.5° 1443
2.5	0.72 0.75	E(0°) 1904 E(C90) 8.2° 943 E(C0) 8.5° 924
3.0	0.86 0.90	E(0°) 1322 E(C90) 8.2° 655 E(C0) 8.5° 642

— C0/C180 (Half-peak divergence: 17.0°)
— C90/C270 (Half-peak divergence: 16.4°)

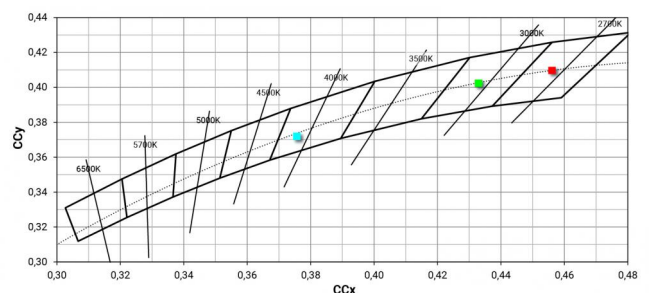
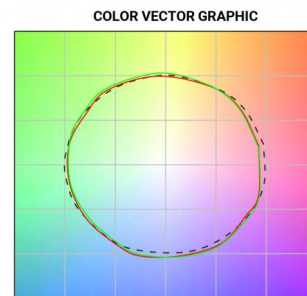

Pound_Focus | Projectors | Accessories
83840W85

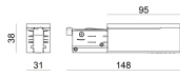

Power Supply - Testata di alimentazione destra bianca (9001/W)
Materiale:policarbonato, colore:Bianco .

Code
81033

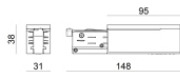

Power Supply - Testata di alimentazione sinistra bianca (9002/W)
Materiale:policarbonato, colore:Bianco .

Code
81036

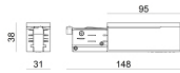

Power Supply - Testata di alimentazione sinistra nera (9002/B)
Materiale:policarbonato, colore:Black.

Code
81037

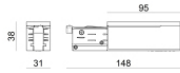

Power Supply - Testata di alimentazione destra nera (9001/B)
Materiale:policarbonato, colore:Black.

Code
81034



Tappo - Tappo di chiusura bianco 9004/W
Materiale:policarbonato, colore:Bianco .

Code
80999



Tappo - Tappo di chiusura nero 9004/B
Materiale:policarbonato, colore:Black.

Code
81000



Tappo - Tappo di chiusura bianco per incasso 9004-R/W
Materiale:policarbonato, colore:Bianco .

Code
81002



Tappo - Tappo di chiusura nero per incasso 9004-R/B
Materiale:policarbonato, colore:Black.

Code
81003

Pound_Focus | Projectors | Accessories
83840W85

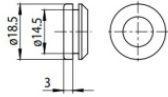

Tappo - Guarnizione bianca (S-9001/115-W)
Materiale: Bianco .

Code
81084

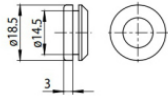

Tappo - Guarnizione nera (S-9001/115-B)
Materiale: Nero , colore: Black.

Code
81085



Rosone - Kit sospensione bianco 1.5m + staffa (9000-KIT5-1,5-W)
Driver incluso: No.
Materiale: plastica, colore: Bianco .

Code
81012

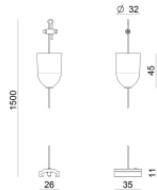

Rosone - Kit sospensione nero 1.5m + staffa (9000-KIT5-1,5-B)
Driver incluso: No.
Materiale: plastica, colore: Black.

Code
81014

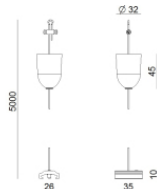

Rosone - Kit sospensione bianco 5m + staffa (9000-KIT5-5-W)
Driver incluso: No.
Materiale: plastica, colore: Bianco .

Code
81013



Rosone - Kit sospensione nero 5m + staffa (9000-KIT5-5-B)
Driver incluso: No.
Materiale: plastica, colore: Black.

Code
81015



Staffa - Staffa anodizzata per fissaggio a soffitto (S-9000/131)
L=35mm, H=14mm, D=24mm.
Materiale: alluminio, colore: Polished aluminium.

Code
81086



Staffa - Staffa anodizzata di irrigidimento (S-9000/333)
L=180mm, H=24mm, D=26mm.
Materiale: alluminio, colore: Anodised aluminium, lavorazione: anodizzazione.

Code
81024

Pound_Focus | Projectors | Accessories
83840W85



Staffa - Staffa bianca di irrigidimento (S-9000/333-W)

L=180mm, H=24mm, D=20mm.

Materiale:alluminio, colore:Bianco RAL 9010, lavorazione:verniciatura.

Code

81025



Staffa - Staffa nera di irrigidimento (S-9000/333-B)

L=180mm, H=24mm, D=20mm.

Materiale:alluminio, colore:Nero RAL 9005, lavorazione:verniciatura.

Code

81026



Staffa - Staffa bianca per fissaggio a soffitto (S-9000/131-W)

L=35mm, H=14mm, D=24mm.

Materiale:alluminio, colore:Bianco , lavorazione:verniciatura.

Code

81087



Staffa - Staffa nera per fissaggio a soffitto (S-9000/131-B)

L=35mm, H=14mm, D=24mm.

Materiale:alluminio, colore:Text black (R9005), lavorazione:verniciatura.

Code

81088

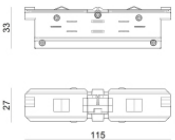

Giunzione - Giunto elettrico bianco - interno (9003/W)

Tipologia linear.

Materiale:policarbonato, colore:Bianco .

Code

81039

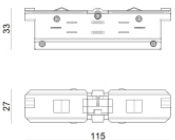

Giunzione - Giunto elettrico nero - interno (9003/B)

Tipologia linear.

Materiale:policarbonato, colore:Black.

Code

81040



Giunzione - Giunto di alimentazione bianco - centrale (9010/W)

Tipologia linear.

Materiale:policarbonato, colore:Bianco .

Code

81042

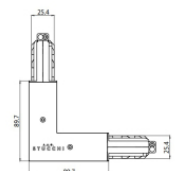

Giunzione - Giunto a L bianco - interno (9011/W)

Tipologia linear.

Materiale:policarbonato, colore:Bianco .











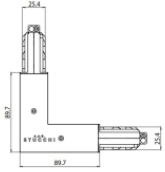

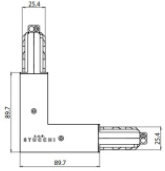
Code

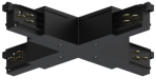
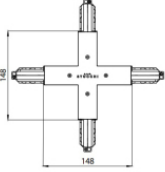
81045

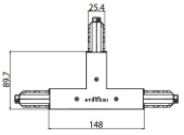
Pound_Focus | Projectors | Accessories
83840W85

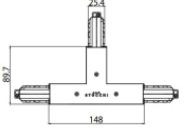
		<p>Giunzione - Giunto a L bianco - esterno (9012/W)</p> <p>Tipologia linear.</p> <p>Materiale:policarbonato, colore:Bianco .</p>	<p>Code <u>81048</u></p>
		<p>Giunzione - Giunto flessibile bianco (9018/W)</p> <p>Tipologia flexible curve.</p> <p>Materiale:policarbonato, colore:Bianco .</p>	<p>Code <u>81066</u></p>
		<p>Giunzione - Giunto a X bianco (9017/W)</p> <p>Tipologia linear.</p> <p>Materiale:policarbonato, colore:Bianco .</p>	<p>Code <u>81063</u></p>
		<p>Giunzione - Giunto a T sinistro bianco - esterno (9013/W)</p> <p>Tipologia linear.</p> <p>Materiale:policarbonato, colore:Bianco .</p>	<p>Code <u>81051</u></p>
		<p>Giunzione - Giunto a T destro bianco - esterno (9014/W)</p> <p>Tipologia linear.</p> <p>Materiale:policarbonato, colore:Bianco .</p>	<p>Code <u>81054</u></p>
		<p>Giunzione - Giunto a T bianco sinistro - interno (9015/W)</p> <p>Tipologia linear.</p> <p>Materiale:policarbonato, colore:Bianco .</p>	<p>Code <u>81057</u></p>
		<p>Giunzione - Giunto a T bianco destro - interno (9016/W)</p> <p>Tipologia linear.</p> <p>Materiale:policarbonato, colore:Bianco .</p>	<p>Code <u>81060</u></p>
		<p>Giunzione - Giunto di alimentazione nero - centrale (9010/B)</p> <p>Tipologia linear.</p> <p>Materiale:policarbonato, colore:Black.</p>	<p>Code <u>81043</u></p>

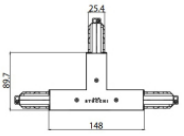
Pound_Focus | Projectors | Accessories
83840W85

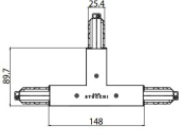
		<p>Giunzione - Giunto a L nero - interno (9011/B)</p> <p>Tipologia linear.</p> <p>Materiale:policarbonato, colore:Black.</p>	<p>Code <u>81046</u></p>
		<p>Giunzione - Giunto a L nero - esterno (9012/B)</p> <p>Tipologia linear.</p> <p>Materiale:policarbonato, colore:Black.</p>	<p>Code <u>81049</u></p>
		<p>Giunzione - Giunto flessibile nero (9018/B)</p> <p>Tipologia flexible curve.</p> <p>Materiale:policarbonato, colore:Black.</p>	<p>Code <u>81067</u></p>
		<p>Giunzione - Giunto a X nero (9017/B)</p> <p>Tipologia linear.</p> <p>Materiale:policarbonato, colore:Black.</p>	<p>Code <u>81064</u></p>
		<p>Giunzione - Giunto a T sinistro nero - esterno (9013/B)</p> <p>Tipologia linear.</p> <p>Materiale:policarbonato, colore:Black.</p>	<p>Code <u>81052</u></p>
		<p>Giunzione - Giunto a T destro nero - esterno (9014/B)</p> <p>Tipologia linear.</p> <p>Materiale:policarbonato, colore:Black.</p>	<p>Code <u>81055</u></p>
		<p>Giunzione - Giunto a T nero sinistro - interno (9015/B)</p> <p>Tipologia linear.</p> <p>Materiale:policarbonato, colore:Black.</p>	<p>Code <u>81058</u></p>
		<p>Giunzione - Giunto a T destro nero - interno (9016/B)</p> <p>Tipologia linear.</p> <p>Materiale:policarbonato, colore:Black.</p>	<p>Code <u>81061</u></p>

Pound_Focus | Projectors | Accessories
83840W85



Sospensioni - Kit sospensione bianco 1.5m (9000-KIT3-1,5-W)
Materiale:plastica, colore:Bianco .

Code
81006



Sospensioni - Kit sospensione bianco 5m (9000-KIT3-5-W)
Materiale:plastica, colore:Bianco .

Code
81007

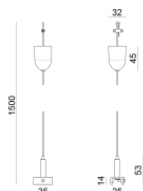

Sospensioni - Kit sospensione nero 1.5m (9000-KIT3-1,5-B)
Materiale:plastica, colore:Black.

Code
81008

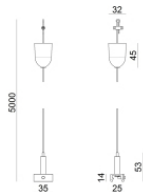

Sospensioni - Kit sospensione nero 5m (9000-KIT3-5-B)
Materiale:plastica, colore:Black.

Code
81009



Sospensioni - Clip per sospensione rigida bianca (S-9000-P2-W)
Materiale:plastica, colore:Bianco .

Code
81018



Sospensioni - Clip per sospensione rigida nera (S-9000-P2-B)
Materiale:plastica, colore:Black.

Code
81019



Sospensioni - Sospensione rigida 1m bianca (S-9000-P3-W)
Materiale:plastica, colore:Bianco .

Code
81021











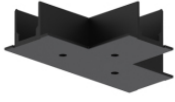
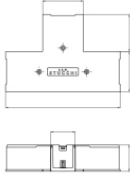
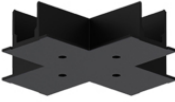
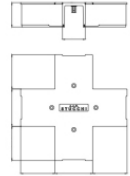

Sospensioni - Sospensione rigida 1m nera (S-9000-P3-B)
Materiale:plastica, colore:Black.

Code
81022

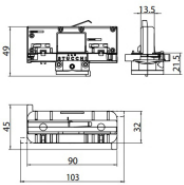
Pound_Focus | Projectors | Accessories
83840W85

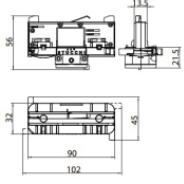
		Coprifilo - Copertura per testata ad incasso bianca (S-9001-R/6-W) Materiale:policarbonato, colore:Bianco .	Code <u>81069</u>
		Coprifilo - Copertura per giunto ad incasso bianco (S-9010-R/6-W) Materiale:policarbonato, colore:Bianco .	Code <u>81072</u>
		Coprifilo - Copertura per giunto L incassato bianco (S-9011-R/6-W) Materiale:policarbonato, colore:Bianco .	Code <u>81075</u>
		Coprifilo - Coperture per giunto T incassato bianco (S-9013-R/6-W) Materiale:policarbonato, colore:Bianco .	Code <u>81078</u>
		Coprifilo - Copertura per giunto X bianco (S-9017-R/6-W) Materiale:policarbonato, colore:Bianco .	Code <u>81081</u>
		Coprifilo - Copertura per testata ad incasso nera (S-9001-R/6-B) Materiale:policarbonato, colore:Black.	Code <u>81070</u>
		Coprifilo - Copertura per giunto ad incasso nero (S-9010-R/6-B) Materiale:policarbonato, colore:Black.	Code <u>81073</u>
		Coprifilo Materiale:policarbonato, colore:Black.	Code <u>81076</u>

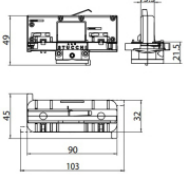
Pound_Focus | Projectors | Accessories
83840W85

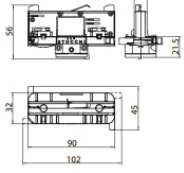
		<p>Coprifilo - Copertura per giunti T incassato nero (S-9013-R/6-B) Materiale:policarbonato, colore:Black.</p>	<p>Code <u>81079</u></p>
		<p>Coprifilo - Copertura per giunto X incassato nero (S-9017-R/6-B) Materiale:policarbonato, colore:Black.</p>	<p>Code <u>81082</u></p>
		<p>Coprifilo Materiale:Bianco .</p>	<p>Code <u>83249</u></p>
		<p>Coprifilo Materiale:Nero , colore:Black.</p>	<p>Code <u>83250</u></p>
		<p>Adattatore trifase/DALI bianco (9009/W)</p>	<p>Code <u>81094</u></p>
		<p>Adattatore trifase bianco (9009-4/W)</p>	<p>Code <u>81091</u></p>
		<p>Adattatore trifase/DALI nero (9009/B)</p>	<p>Code <u>81095</u></p>
		<p>adattatore trifase nero (9009-4/B)</p>	<p>Code <u>81093</u></p>

	<p>Utensile - Tronchese S-9000/T Materiale:gomma, colore:Black.</p>	<p>Code <u>81005</u></p>
 	<p>Binario - Binario Incassato Trifase DALI Bianco, 1 m (9000-1/W-R) Lunghezza: 1000mm; Tipo binario: Standard. Materiale:alluminio, colore:Text white (R9003), lavorazione:verniciatura.</p>	<p>Code <u>80990</u></p>
 	<p>Binario - Binario Incassato Trifase DALI Bianco, 2 m (9000-2/W-R) Lunghezza: 2000mm; Tipo binario: Standard. Materiale:alluminio, colore:Text white (R9003), lavorazione:verniciatura.</p>	<p>Code <u>80991</u></p>
 	<p>Binario - Binario Incassato Trifase DALI Bianco, 3 m (9000-3/W-R) Lunghezza: 3000mm; Tipo binario: Standard. Materiale:alluminio, colore:Text white (R9003), lavorazione:verniciatura.</p>	<p>Code <u>80992</u></p>
 	<p>Binario - Binario Incassato Trifase DALI Nero, 1 m (9000-1/B-R) Lunghezza: 1000mm; Tipo binario: Standard. Materiale:alluminio, colore:Text black (R9005), lavorazione:verniciatura.</p>	<p>Code <u>80993</u></p>
 	<p>Binario - Binario Incassato Trifase DALI Nero, 2 m (9000-2/B-R) Lunghezza: 2000mm; Tipo binario: Standard. Materiale:alluminio, colore:Text black (R9005), lavorazione:verniciatura.</p>	<p>Code <u>80994</u></p>
 	<p>Binario - Binario Incassato Trifase DALI Nero, 3 m (9000-3/B-R) Lunghezza: 3000mm; Tipo binario: Standard. Materiale:alluminio, colore:Text black (R9005), lavorazione:verniciatura.</p>	<p>Code <u>80995</u></p>
 	<p>Binario Lunghezza: 1000mm; Tipo binario: Standard. Materiale:alluminio, colore:Text white (R9003), lavorazione:verniciatura.</p>	<p>Code <u>83336</u></p>

Pound_Focus | Projectors | Accessories
83840W85

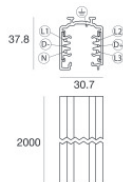

Binario

Lunghezza: 2000mm; Tipo binario: Standard.

Materiale:alluminio, colore:Text white (R9003), lavorazione:verniciatura.

Code

83337

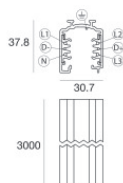

Binario

Lunghezza: 3000mm; Tipo binario: Standard.

Materiale:alluminio, colore:Text white (R9003), lavorazione:verniciatura.

Code

83338

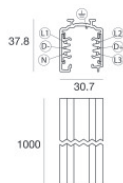

Binario

Lunghezza: 1000mm; Tipo binario: Standard.

Materiale:alluminio, colore:Text black (R9005), lavorazione:verniciatura.

Code

83339

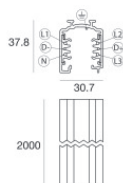

Binario

Lunghezza: 2000mm; Tipo binario: Standard.

Materiale:alluminio, colore:Text black (R9005), lavorazione:verniciatura.

Code

83340

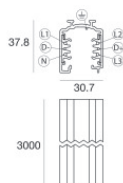

Binario

Lunghezza: 3000mm; Tipo binario: Standard.

Materiale:alluminio, colore:Text black (R9005), lavorazione:verniciatura.

Code

83341

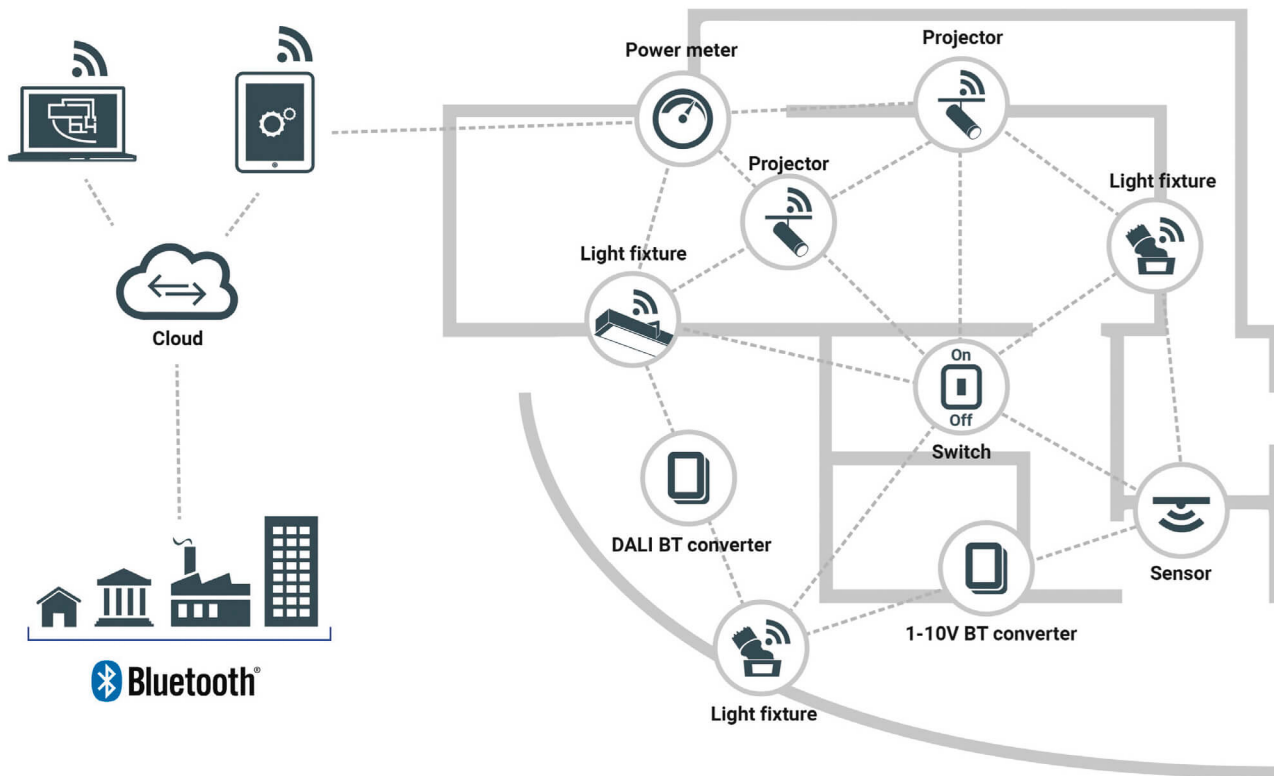

Identificazione dispositivo

Alla prima accensione del dispositivo e ogni volta che viene effettuato il reset, il sistema effettua l'identificazione della lampada. L'identificazione consiste in un'animazione definita "Attention event" con il 40% di luminosità per 500ms, 100% di luminosità per 500 ms. Anche il LED blu di stato effettua un lampeggio durante la fase di identificazione con 500ms ON/500ms OFF.

Ripristino delle impostazioni di fabbrica del dispositivo

Bluetooth – Factory reset for Bluetooth device Un ripristino delle impostazioni di fabbrica cambierà lo stato del modulo nella rete mesh da connesso a non connesso, ovvero tutte le impostazioni di rete andranno perse. Questa funzionalità è necessaria per ripristinare la connessione di un dispositivo dopo un comportamento imprevisto in cui si perde il controllo del dispositivo. Per effettuare il ripristino alle impostazioni di fabbrica dell'apparecchiatura Bluetooth è sufficiente portare a contatto un magnete al simbolo indicato nell'involucro contenente il modulo Bluetooth. Mettere a contatto il magnete per 5 secondi. Una volta effettuato il ripristino alle impostazioni di fabbrica, il sistema effettuerà un'identificazione del dispositivo.



Antenna

L'antenna è incorporata all'interno dell'articolo.

Lampeggio del LED

Il LED blu di stato posizionato nell'involucro contenente l'interfaccia Bluetooth effettua una serie di lampeggi a seconda dello stato in cui la lampada si trova.

Lampeggio veloce / lampeggio lento

Il LED effettua un lampeggio veloce se la lampada non è connessa alla rete (ogni 300ms) Il LED effettua un lampeggio lento se la lampada è connessa alla rete (ogni 2s)

Lampada non connessa



Lampada connessa



Lampeggio durante il reset alle impostazioni di fabbrica

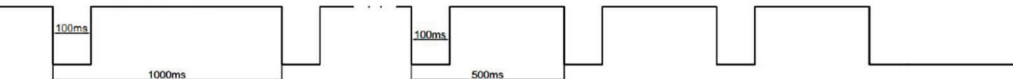

Ricevimento di un pacchetto mesh



Altre informazioni

- La portata wireless potrebbe essere influenzata, in modo particolare dalle superfici metalliche. In queste condizioni la portata wireless deve essere verificata.
- Se il dispositivo non è connesso ad una rete ci vorranno circa 30 secondi perché sia visualizzato come dispositivo disponibile dopo essere stato acceso.
- Il dispositivo ha superato con successo il processo di test SILVAIR
- Supporta gli switch EnOcean 83017
- Supporta i sensori Murata 83016
- Lo strumento può essere messo in funzione attraverso l'applicazione di messa in servizio SILVAR presente nell'app store del proprio smartphone o tablet.
- Per ulteriori informazioni consultare la guida SILVAIR al seguente link: <https://silvair.com/resources/product-documents/>
- Linea Light non avrà alcuna responsabilità per qualsiasi strumento di messa in servizio di terze parti e non fornisce alcuna dichiarazione, espressa o implicita, sulla disponibilità e / o sulle prestazioni di tale strumento di messa in servizio.

**POUND_T
POUND FOCUS**

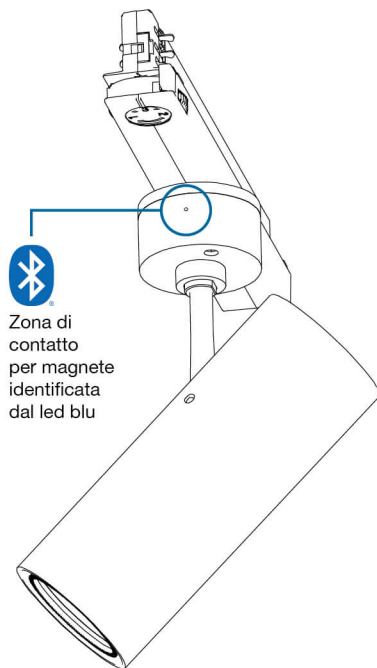

POUND SHAPER

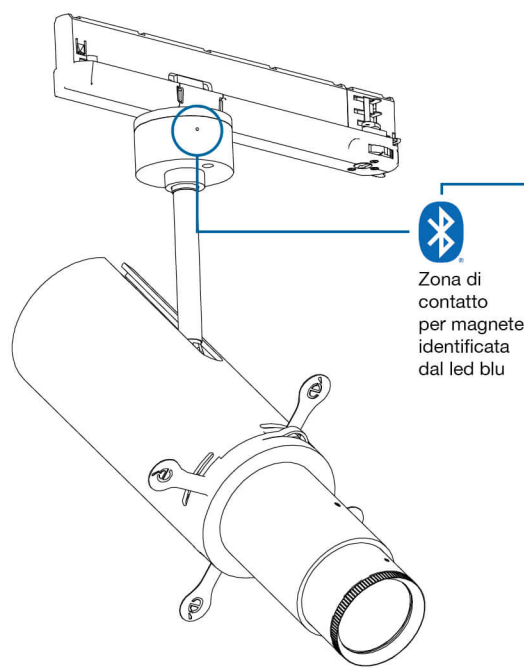

OPTUS_T

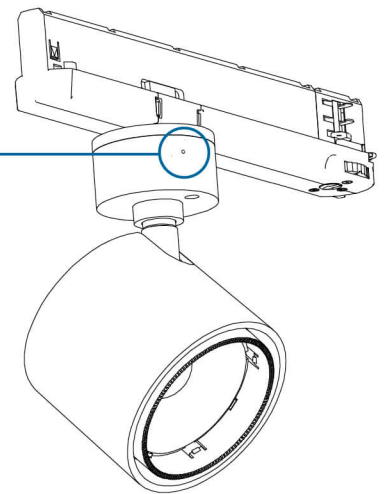

OPTUS_Ww

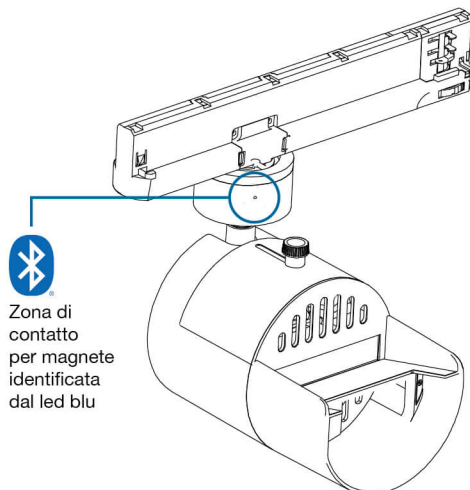

Base
**NAVATA OPTUS
NAVATA POUND
SHAPER**

