

Proiettori | 198-264 V
1 arrayLED 32.5 W DC | 37.5 W AC | CRI 98
83823W30

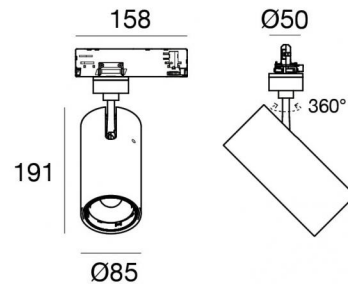

Dati tecnici	
Tipologia	Binario
Posizione installativa	Soffitto
Ambiente installativo	Indoor
Sorgente luminosa	Tecnologia LED
Struttura del circuito	arrayLED
Ottica	Flood
Direzione emissione luminosa	frontale
Potenza nominale	32.5 W DC
Potenza totale	37.5 W
Flusso luminoso sorgente	4225 lm
Tensione nominale di ingresso	220 - 240 V AC
Range di tensione in ingresso	198 - 264 V AC
Frequenza	50 - 60 Hz
CCT / Tonalità	3000 K
Indice di resa cromatica	98 Ra
C.C. / C.V.	AC
Classe di isolamento	2
IP	IP20
Prova del filo incandescente	850°
Montaggio diretto su superfici normalmente infiammabili	Si
CE	Si
Driver incluso	Driver
Articolo dimmerabile	Bluetooth
Orientabilità	Orientabile
angolo totale (piano verticale)	90 °
angolo totale (piano orizzontale)	360 °
Basculante	No
Calpestabilità	No
Carrabilità	No
Cavo incluso	No
Resinatura	No
Tipologia di emissione luminosa	Singola emissione
Peso netto	0.92 Kg
Protezione scariche elettrostatiche	Si
Protezione surge	2 KV
Tecnologia ottica	Anti - Glare

Finitura Finitura corpo	
Materiale	Alluminio Pressofuso EN AB - 46100
Colore	Text white (R9003)
Lavorazione	Verniciatura a polvere termoindurente

Technology Partner
SILVAIR

Proiettori | 198-264 V | 1 arrayLED 32.5 W DC - 37.5 W AC | CRI 98 | Base 83823W30

Proiettori a singola emissione per applicazione indoor. La sorgente luminosa LED, di colore bianco caldo, con distribuzione luminosa Flood, è composta da 1 LED arrayed, con una CCT 3000 K ed un CRI 98; il flusso luminoso della sorgente è di 4225 lm, con un'efficienza nominale di 130.0 lm/W.

Il corpo dell'apparecchio, realizzato in alluminio pressofuso en ab - 46100, presenta una finitura di colore text white (r9003), ottenuta tramite verniciatura a polvere termoidurente.

Il grado di protezione è IP20; il peso complessivo è di 0.92 kg.

La potenza assorbita dall'apparecchio è di 37.5 W

L'apparecchio presenta una classe di isolamento II ed è installabile a soffitto.

Conforme alla norma EN 60598-1 e alle relative prescrizioni particolari.

Classe di efficienza energetica

Questo prodotto contiene una sorgente luminosa di classe di efficienza energetica D.

Caratteristiche Illuminotecniche

Resa luminosa apparecchio (LOR)	75 %
Flusso luminoso sorgente	4225 lm
Flusso luminoso apparecchio	3189 lm
Potenza reale apparecchio	37.5 W
Efficienza reale apparecchio	85 lm/W
Temperatura di colore	3000 K
Deviazione standard di corrispondenza colore	2 Step MacAdam
Indice di resa cromatica	98 Ra
Black Body Locus	On
Temperatura standard dell'ambiente di esercizio	-20 / +50°C
Temperatura tipica sul vetro	40°C

LED Life / Failure Ratio

L70 B10 C0 235315h (at Tj 65 Ta 25)
L80 B10 C0 147343h (at Tj 65 Ta 25)
L90 B10 C0 69745h (at Tj 65 Ta 25)

UGR

UGR axial	16.5
UGR transversal	16.6
X=4H Y=8H	S=0.25H
Reflection factor	70/50/20

OPTICAL

Ottica C0/C180	24°
Light distribution simmetry	Symmetrical

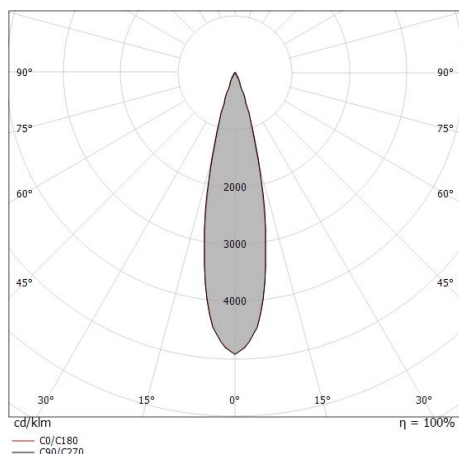

Distance [m]	Cone diameter [m]	illuminance [lx]
0.5	0.21 0.21	E(0°) 62753 E(C90) 29453 E(C0) 29584
1.0	0.43 0.42	E(0°) 15688 E(C90) 7363 E(C0) 7396
1.5	0.64 0.63	E(0°) 6973 E(C90) 3273 E(C0) 3267
2.0	0.85 0.84	E(0°) 3922 E(C90) 1841 E(C0) 1849
2.5	1.06 1.05	E(0°) 2510 E(C90) 1178 E(C0) 1183
3.0	1.28 1.26	E(0°) 1743 E(C90) 818 E(C0) 822

— C0/C180 (Half-peak divergence: 23.8°)
— C90/C270 (Half-peak divergence: 24.0°)

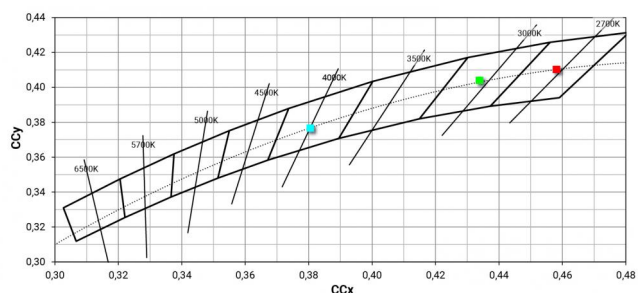
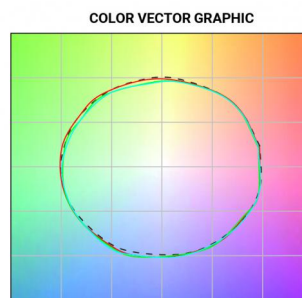

Pound_T | Projectors | Accessories
83823W30



Ottica - SPOT
Distribuzione ottica: spot, Materiale rivestimento: policarbonato uv resistente

Code
C-U300015



Ottica - WIDE FLOOD
Distribuzione ottica: medium flood, Materiale rivestimento: policarbonato uv resistente

Code
C-U300017



Antiabbagliamento
Tipo Antiabbagliamento: frangiluce nido d'ape.
Materiale:Pom-C, colore:Nero.

Code
C-U300014

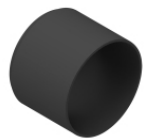

Antiabbagliamento
Tipo Antiabbagliamento: schermo cilindrico.
Materiale:Pom-C, colore:Nero.

Code
C-U300029



Antiabbagliamento
Tipo Antiabbagliamento: schermo cilindrico 45°.
Materiale:Pom-C, colore:Nero.

Code
C-U300030

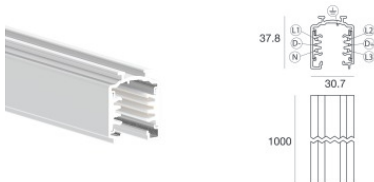

Binario
Lunghezza: 1000mm; Tipo binario: Standard.
Materiale:alluminio, colore:Text white (R9003), lavorazione:verniciatura.

Code
83336

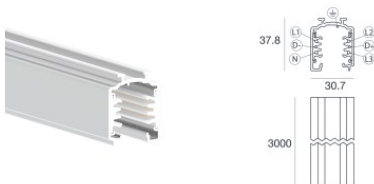

Binario
Lunghezza: 3000mm; Tipo binario: Standard.
Materiale:alluminio, colore:Text white (R9003), lavorazione:verniciatura.

Code
83338



Binario - Binario Incassato Trifase DALI Bianco, 1 m (9000-1/W-R)
Lunghezza: 1000mm; Tipo binario: Standard.
Materiale:alluminio, colore:Text white (R9003), lavorazione:verniciatura.

Code
80990

Pound_T | Projectors | Accessories
83823W30

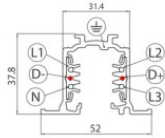

Binario - Binario Incassato Trifase DALI Bianco, 2 m (9000-2/W-R)
Lunghezza: 2000mm; Tipo binario: Standard.
Materiale:alluminio, colore:Text white (R9003), lavorazione:verniciatura.

Code
80991



Diffusore - Non è compatibile con l'ottica da 60°

Code
C-U300013

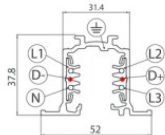

Binario - Binario Incassato Trifase DALI Nero, 1 m (9000-1/B-R)
Lunghezza: 1000mm; Tipo binario: Standard.
Materiale:alluminio, colore:Text black (R9005), lavorazione:verniciatura.

Code
80993



Ottica - FLOOD
Distribuzione ottica: flood,Materiale rivestimento: policarbonato uv resistente

Code
C-U300016

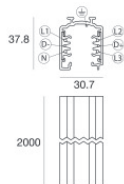

Binario
Lunghezza: 2000mm; Tipo binario: Standard.
Materiale:alluminio, colore:Text black (R9005), lavorazione:verniciatura.

Code
83340

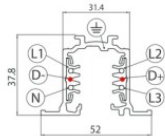

Binario - Binario Incassato Trifase DALI Bianco, 3 m (9000-3/W-R)
Lunghezza: 3000mm; Tipo binario: Standard.
Materiale:alluminio, colore:Text white (R9003), lavorazione:verniciatura.

Code
80992

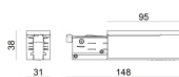

Power Supply - Testata di alimentazione destra nera (9001/B)
Materiale:policarbonato, colore:Black.

Code
81034

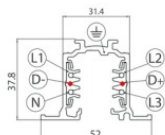

Binario - Binario Incassato Trifase DALI Nero, 2 m (9000-2/B-R)
Lunghezza: 2000mm; Tipo binario: Standard.
Materiale:alluminio, colore:Text black (R9005), lavorazione:verniciatura.

Code
80994

Pound_T | Projectors | Accessories
83823W30

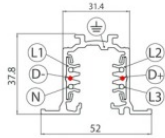

Binario - Binario Incassato Trifase DALI Nero, 3 m (9000-3/B-R)
Lunghezza: 3000mm; Tipo binario: Standard.
Materiale:alluminio, colore:Text black (R9005), lavorazione:verniciatura.

Code
80995

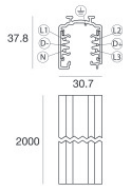

Binario
Lunghezza: 2000mm; Tipo binario: Standard.
Materiale:alluminio, colore:Text white (R9003), lavorazione:verniciatura.

Code
83337



Giunzione - Giunto di alimentazione nero - centrale (9010/B)
Tipologia linear.
Materiale:policarbonato, colore:Black.

Code
81043



Giunzione - Giunto flessibile nero (9018/B)
Tipologia flexible curve.
Materiale:policarbonato, colore:Black.

Code
81067



Giunzione - Giunto di alimentazione bianco - centrale (9010/W)
Tipologia linear.
Materiale:policarbonato, colore:Bianco .

Code
81042



Power Supply - Testata di alimentazione sinistra nera (9002/B)
Materiale:policarbonato, colore:Black.

Code
81037

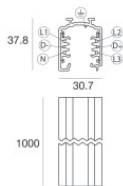

Binario
Lunghezza: 1000mm; Tipo binario: Standard.
Materiale:alluminio, colore:Text black (R9005), lavorazione:verniciatura.

Code
83339



Power Supply - Testata di alimentazione sinistra bianca (9002/W)
Materiale:policarbonato, colore:Bianco .

Code
81036

Pound_T | Projectors | Accessories
83823W30



Tappo - Tappo di chiusura bianco 9004/W
Materiale:policarbonato, colore:Bianco .

Code
80999

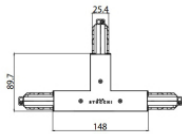

Giunzione - Giunto a T sinistro bianco - esterno (9013/W)
Tipologia linear.
Materiale:policarbonato, colore:Bianco .

Code
81051

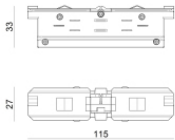

Giunzione - Giunto elettrico bianco - interno (9003/W)
Tipologia linear.
Materiale:policarbonato, colore:Bianco .

Code
81039



Giunzione - Giunto flessibile bianco (9018/W)
Tipologia flexible curve.
Materiale:policarbonato, colore:Bianco .

Code
81066

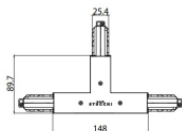

Giunzione - Giunto a T destro bianco - esterno (9014/W)
Tipologia linear.
Materiale:policarbonato, colore:Bianco .

Code
81054

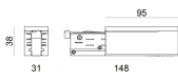

Power Supply - Testata di alimentazione destra bianca (9001/W)
Materiale:policarbonato, colore:Bianco .

Code
81033

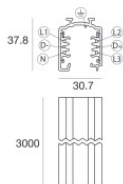

Binario
Lunghezza: 3000mm; Tipo binario: Standard.
Materiale:alluminio, colore:Text black (R9005), lavorazione:verniciatura.

Code
83341

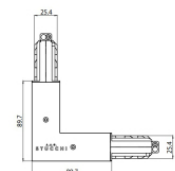

Giunzione - Giunto a L bianco - esterno (9012/W)
Tipologia linear.
Materiale:policarbonato, colore:Bianco .

Code
81048

Pound_T | Projectors | Accessories
83823W30

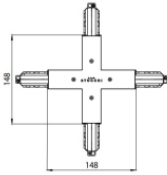
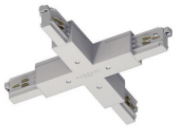

Giunzione - Giunto a X bianco (9017/W)
Tipologia linear.
Materiale:policarbonato, colore:Bianco .

Code
81063



Tappo - Tappo di chiusura nero 9004/B
Materiale:policarbonato, colore:Black.

Code
81000

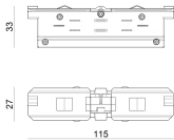

Giunzione - Giunto elettrico nero - interno (9003/B)
Tipologia linear.
Materiale:policarbonato, colore:Black.

Code
81040

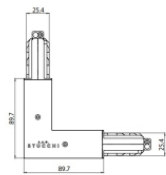

Giunzione - Giunto a L nero - interno (9011/B)
Tipologia linear.
Materiale:policarbonato, colore:Black.

Code
81046

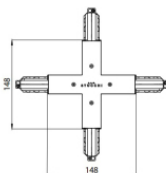
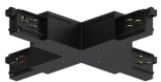

Giunzione - Giunto a X nero (9017/B)
Tipologia linear.
Materiale:policarbonato, colore:Black.

Code
81064

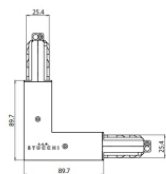

Giunzione - Giunto a L nero - esterno (9012/B)
Tipologia linear.
Materiale:policarbonato, colore:Black.

Code
81049

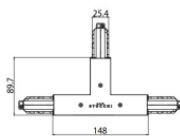

Giunzione - Giunto a T destro nero - interno (9016/B)
Tipologia linear.
Materiale:policarbonato, colore:Black.

Code
81061

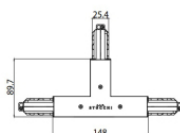

Giunzione - Giunto a T bianco destro - interno (9016/W)
Tipologia linear.
Materiale:policarbonato, colore:Bianco .

Code
81060

Pound_T | Projectors | Accessories
83823W30

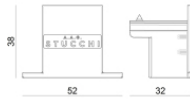

Tappo - Tappo di chiusura nero per incasso 9004-R/B
Materiale:policarbonato, colore:Black.

Code
81003



Rosone - Kit sospensione bianco 1.5m + staffa (9000-KIT5-1,5-W)
Driver incluso: No.
Materiale:plastica, colore:Bianco .

Code
81012



Tappo - Tappo di chiusura bianco per incasso 9004-R/W
Materiale:policarbonato, colore:Bianco .

Code
81002



Rosone - Kit sospensione nero 5m + staffa (9000-KIT5-5-B)
Driver incluso: No.
Materiale:plastica, colore:Black.

Code
81015

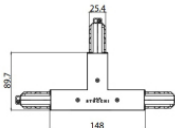

Giunzione - Giunto a T sinistro nero - esterno (9013/B)
Tipologia linear.
Materiale:policarbonato, colore:Black.

Code
81052



Sospensioni - Sospensione rigida 1m bianca (S-9000-P3-W)
Materiale:plastica, colore:Bianco .

Code
81021

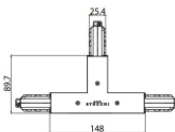

Giunzione - Giunto a T destro nero - esterno (9014/B)
Tipologia linear.
Materiale:policarbonato, colore:Black.

Code
81055



Sospensioni - Sospensione rigida 1m nera (S-9000-P3-B)
Materiale:plastica, colore:Black.

Code
81022

Pound_T | Projectors | Accessories
83823W30

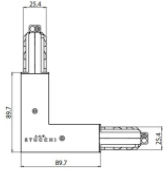

Giunzione - Giunto a L bianco - interno (9011/W)
Tipologia linear.
Materiale:policarbonato, colore:Bianco .

Code
81045



Coprifilo - Copertura per testata ad incasso bianca (S-9001-R/6-W)
Materiale:policarbonato, colore:Bianco .

Code
81069

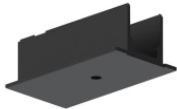

Coprifilo - Copertura per testata ad incasso nera (S-9001-R/6-B)
Materiale:policarbonato, colore:Black.

Code
81070

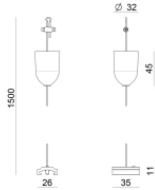

Rosone - Kit sospensione nero 1.5m + staffa (9000-KIT5-1,5-B)
Driver incluso: No.
Materiale:plastica, colore:Black.

Code
81014

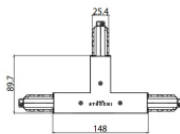

Giunzione - Giunto a T bianco sinistro - interno (9015/W)
Tipologia linear.
Materiale:policarbonato, colore:Bianco .

Code
81057



Coprifilo - Copertura per giunto L incassato bianco (S-9011-R/6-W)
Materiale:policarbonato, colore:Bianco .

Code
81075



Staffa - Staffa bianca per fissaggio a soffitto (S-9000/131-W)
L=35mm, H=14mm, D=24mm.
Materiale:alluminio, colore:Bianco , lavorazione:verniciatura.

Code
81087

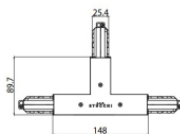

Giunzione - Giunto a T nero sinistro - interno (9015/B)
Tipologia linear.
Materiale:policarbonato, colore:Black.

Code
81058

Pound_T | Projectors | Accessories
83823W30

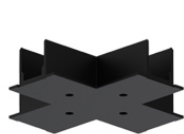

Coprifilo - Copertura per giunto X incassato nero (S-9017-R/6-B)
Materiale:policarbonato, colore:Black.

Code
81082



Utensile - Tronchese S-9000/T
Materiale:gomma, colore:Black.

Code
81005



Staffa - Staffa nera per fissaggio a soffitto (S-9000/131-B)
L=35mm, H=14mm, D=24mm.
Materiale:alluminio, colore:Text black (R9005), lavorazione:verniciatura.

Code
81088

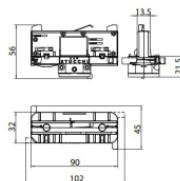

Adattatore trifase bianco (9009-4/W)

Code
81091



Coprifilo
Materiale:policarbonato, colore:Black.

Code
81076



Staffa - Staffa anodizzata per fissaggio a soffitto (S-9000/131)
L=35mm, H=14mm, D=24mm.
Materiale:alluminio, colore:Polished aluminium.

Code
81086

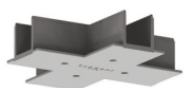

Coprifilo - Copertura per giunto X bianco (S-9017-R/6-W)
Materiale:policarbonato, colore:Bianco .

Code
81081



Sospensioni - Clip per sospensione rigida nera (S-9000-P2-B)
Materiale:plastica, colore:Black.

Code
81019

Pound_T | Projectors | Accessories
83823W30



Sospensioni - Clip per sospensione rigida bianca (S-9000-P2-W)
Materiale:plastica, colore:Bianco .

Code
81018

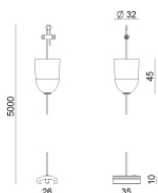

Rosone - Kit sospensione bianco 5m + staffa (9000-KIT5-5-W)
Driver incluso: No.
Materiale:plastica, colore:Bianco .

Code
81013



Staffa - Staffa anodizzata di irrigidimento (S-9000/333)
L=180mm, H=24mm, D=26mm.
Materiale:alluminio, colore:Anodised aluminium, lavorazione:anodizzazione.

Code
81024



Sospensioni - Kit sospensione bianco 1.5m (9000-KIT3-1,5-W)
Materiale:plastica, colore:Bianco .

Code
81006

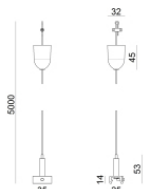

Sospensioni - Kit sospensione nero 5m (9000-KIT3-5-B)
Materiale:plastica, colore:Black.

Code
81009



Sospensioni - Kit sospensione bianco 5m (9000-KIT3-5-W)
Materiale:plastica, colore:Bianco .

Code
81007



Staffa - Staffa bianca di irrigidimento (S-9000/333-W)
L=180mm, H=24mm, D=20mm.
Materiale:alluminio, colore:Bianco RAL 9010, lavorazione:verniciatura.

Code
81025



Staffa - Staffa nera di irrigidimento (S-9000/333-B)
L=180mm, H=24mm, D=20mm.
Materiale:alluminio, colore:Nero RAL 9005, lavorazione:verniciatura.

Code
81026

Pound_T | Projectors | Accessories
83823W30

		adattatore trifase nero (9009-4/B)	Code <u>81093</u>
		Coprifilo - Coperture per giunto T incassato bianco (S-9013-R/6-W) Materiale:policarbonato, colore:Bianco .	Code <u>81078</u>
		Sospensioni - Kit sospensione nero 1.5m (9000-KIT3-1,5-B) Materiale:plastica, colore:Black.	Code <u>81008</u>
		Coprifilo - Copertura per giunti T incassato nero (S-9013-R/6-B) Materiale:policarbonato, colore:Black.	Code <u>81079</u>
		Coprifilo - Copertura per giunto ad incasso bianco (S-9010-R/6-W) Materiale:policarbonato, colore:Bianco .	Code <u>81072</u>
		Coprifilo - Copertura per giunto ad incasso nero (S-9010-R/6-B) Materiale:policarbonato, colore:Black.	Code <u>81073</u>
		Coprifilo Materiale:Nero , colore:Black.	Code <u>83250</u>
		Coprifilo Materiale:Bianco .	Code <u>83249</u>

Pound_T | Projectors | Accessories
83823W30

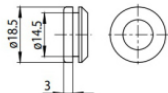

Tappo - Guarnizione nera (S-9001/115-B)
Materiale:Nero , colore:Black.

Code
81085

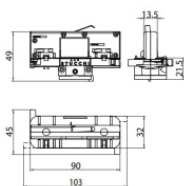

Adattatore trifase/DALI bianco (9009/W)

Code
81094

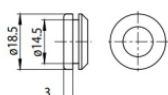

Tappo - Guarnizione bianca (S-9001/115-W)
Materiale:Bianco .

Code
81084

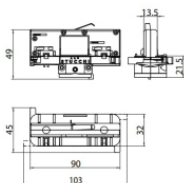

Adattatore trifase/DALI nero (9009/B)

Code
81095

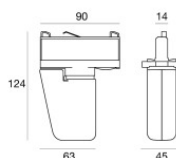

Accessorio elettronica - Controller TWIL-DALI per dispositivi con protocollo DALI installati su binario trifase.
posizione installativa: soffitto L=90mm, H=124mm, D=45mm.
Materiale:Plastica ABS, colore:Black.

Code
C-E700008

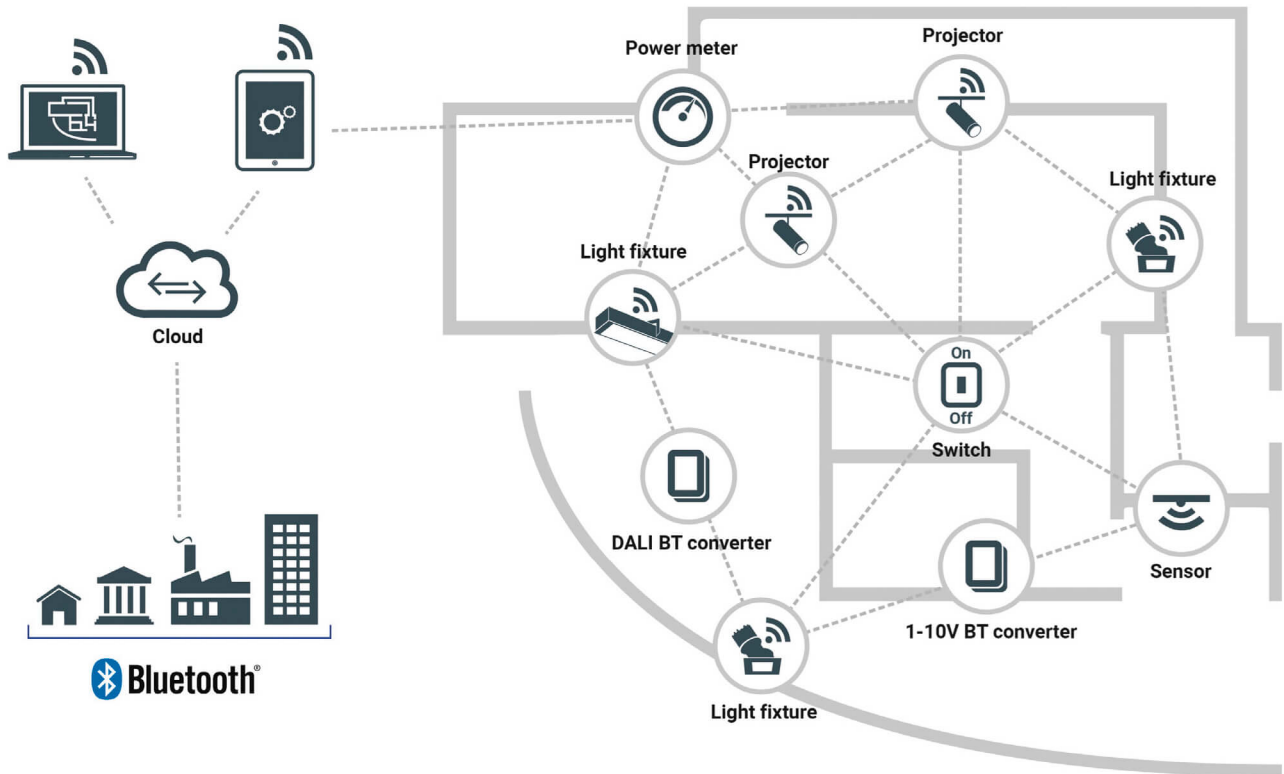

Identificazione dispositivo

Alla prima accensione del dispositivo e ogni volta che viene effettuato il reset, il sistema effettua l'identificazione della lampada. L'identificazione consiste in un'animazione definita "Attention event" con il 40% di luminosità per 500ms, 100% di luminosità per 500 ms. Anche il LED blu di stato effettua un lampeggio durante la fase di identificazione con 500ms ON/500ms OFF.

Ripristino delle impostazioni di fabbrica del dispositivo

Bluetooth – Factory reset for Bluetooth device Un ripristino delle impostazioni di fabbrica cambierà lo stato del modulo nella rete mesh da connesso a non connesso, ovvero tutte le impostazioni di rete andranno perse. Questa funzionalità è necessaria per ripristinare la connessione di un dispositivo dopo un comportamento imprevisto in cui si perde il controllo del dispositivo. Per effettuare il ripristino alle impostazioni di fabbrica dell'apparecchiatura Bluetooth è sufficiente portare a contatto un magnete al simbolo indicato nell'involucro contenente il modulo Bluetooth. Mettere a contatto il magnete per 5 secondi. Una volta effettuato il ripristino alle impostazioni di fabbrica, il sistema effettuerà un'identificazione del dispositivo.



Antenna

L'antenna è incorporata all'interno dell'articolo.

Lampeggio del LED

Il LED blu di stato posizionato nell'involucro contenente l'interfaccia Bluetooth effettua una serie di lampeggi a seconda dello stato in cui la lampada si trova.

Lampeggio veloce / lampeggio lento

Il LED effettua un lampeggio veloce se la lampada non è connessa alla rete (ogni 300ms) Il LED effettua un lampeggio lento se la lampada è connessa alla rete (ogni 2s)

Lampada non connessa



Lampada connessa



Lampeggio durante il reset alle impostazioni di fabbrica

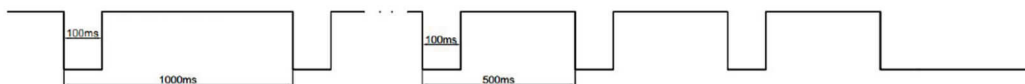

Ricevimento di un pacchetto mesh



Altre informazioni

- La portata wireless potrebbe essere influenzata, in modo particolare dalle superfici metalliche. In queste condizioni la portata wireless deve essere verificata.
- Se il dispositivo non è connesso ad una rete ci vorranno circa 30 secondi perché sia visualizzato come dispositivo disponibile dopo essere stato acceso.
- Il dispositivo ha superato con successo il processo di test SILVAIR
- Supporta gli switch EnOcean 83017
- Supporta i sensori Murata 83016
- Lo strumento può essere messo in funzione attraverso l'applicazione di messa in servizio SILVAR presente nell'app store del proprio smartphone o tablet.
- Per ulteriori informazioni consultare la guida SILVAIR al seguente link: <https://silvair.com/resources/product-documents/>
- Linea Light non avrà alcuna responsabilità per qualsiasi strumento di messa in servizio di terze parti e non fornisce alcuna dichiarazione, espressa o implicita, sulla disponibilità e / o sulle prestazioni di tale strumento di messa in servizio.

**POUND_T
POUND FOCUS**

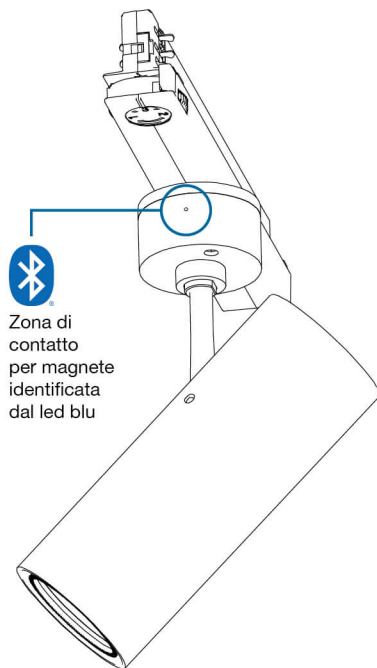

POUND SHAPER

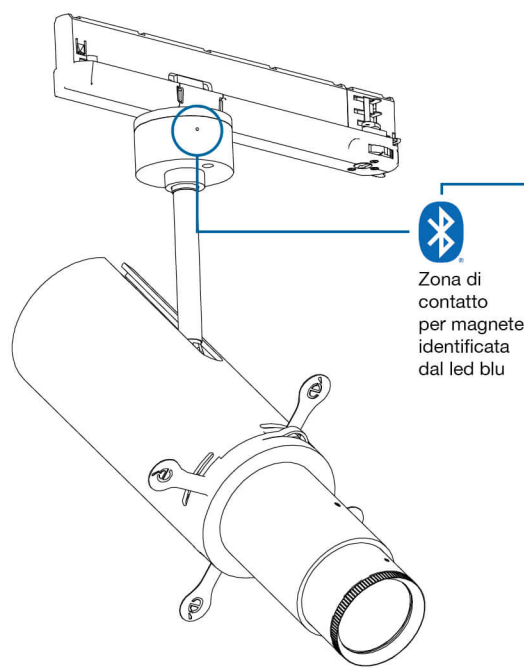

OPTUS_T

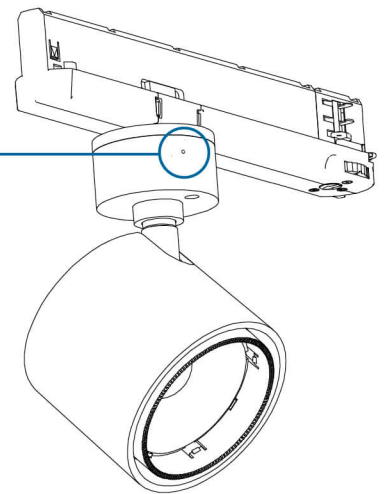

OPTUS_Ww

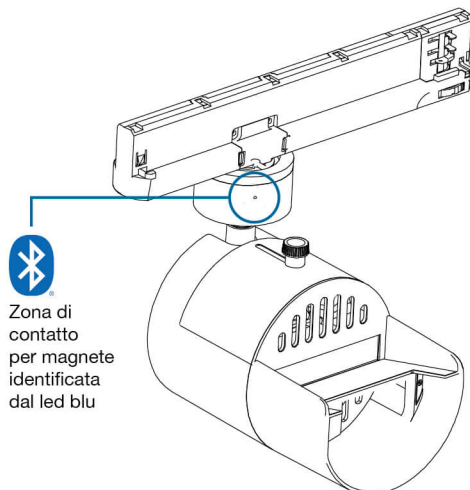

Base
**NAVATA OPTUS
NAVATA POUND
SHAPER**

