

Proiettori | 198-264 V
1 arrayLED 13 W DC - 15.5 W AC | CRI 90
83803M30

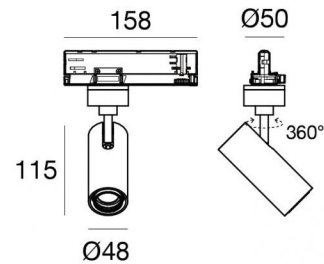

Dati tecnici	
Tipologia	Binario
Posizione installativa	Soffitto
Ambiente installativo	Indoor
Sorgente luminosa	Tecnologia LED
Struttura del circuito	arrayLED
Ottica	Flood
Direzione emissione luminosa	frontale
Potenza nominale	13 W DC
Potenza totale	15.5 W
Flusso luminoso sorgente	1669 lm
Tensione nominale di ingresso	220 - 240 V AC
Range di tensione in ingresso	198 - 264 V AC
Frequenza	50 - 60 Hz
CCT / Tonalità	2700 K
Indice di resa cromatica	90 Ra
C.C. / C.V.	AC
Classe di isolamento	2
IP	IP20
Prova del filo incandescente	850°
Montaggio diretto su superfici normalmente infiammabili	Si
CE	Si
Driver incluso	Driver
Articolo dimmerabile	Bluetooth
Orientabilità	Orientabile
angolo totale (piano verticale)	90 °
angolo totale (piano orizzontale)	360 °
Basculante	No
Calpestabilità	No
Carrabilità	No
Cavo incluso	No
Resinatura	No
Tipologia di emissione luminosa	Singola emissione
Peso netto	0.39 Kg
Protezione scariche elettrostatiche	Si
Protezione surge	2 KV
Tecnologia ottica	Anti - Glare

Finitura Finitura corpo	
Materiale	Alluminio Pressofuso EN AB - 46100
Colore	Text white (R9003)
Lavorazione	Verniciatura a polvere termoidurente

Technology Partner
SILVAIR

Proiettori | 198-264 V | 1 arrayLED 13 W DC - 15.5 W AC | CRI 90 | Base 83803M30

Proiettori a singola emissione per applicazione indoor. La sorgente luminosa LED, di colore bianco super caldo, con distribuzione luminosa Flood, è composta da 1 LED arrayed, con una CCT 2700 K ed un CRI 90; il flusso luminoso della sorgente è di 1669 lm, con un'efficienza nominale di 128.4 lm/W.

Il corpo dell'apparecchio, realizzato in alluminio pressofuso en ab - 46100, presenta una finitura di colore text white (r9003), ottenuta tramite verniciatura a polvere termoidurente.

Il grado di protezione è IP20; il peso complessivo è di 0.39 kg.

La potenza assorbita dall'apparecchio è di 15.5 W

L'apparecchio presenta una classe di isolamento II ed è installabile a soffitto.

Conforme alla norma EN 60598-1 e alle relative prescrizioni particolari.

Classe di efficienza energetica

Questo prodotto contiene una sorgente luminosa di classe di efficienza energetica E.

Caratteristiche Illuminotecniche

Resa luminosa apparecchio (LOR)	70 %
Flusso luminoso sorgente	1669 lm
Flusso luminoso apparecchio	1170 lm
Potenza reale apparecchio	15.5 W
Efficienza reale apparecchio	75 lm/W
Temperatura di colore	2700 K
Deviazione standard di corrispondenza colore	2 Step MacAdam
Indice di resa cromatica	90 Ra
Indice Resa Cromatica	60 R9
Black Body Locus	On
Temperatura standard dell'ambiente di esercizio	-20 / +50°C
Temperatura tipica sul vetro	40°C

LED Life / Failure Ratio

L70 B10 C0 231262h (at Tj 65 Ta 25)
L80 B10 C0 144799h (at Tj 65 Ta 25)
L90 B10 C0 68534h (at Tj 65 Ta 25)

UGR

UGR axial	16.6
UGR transversal	16.3
X=4H Y=8H	S=0.25H
Reflection factor	70/50/20

OPTICAL

Optica C0/C180	25°
Light distribution simmetry	Symmetrical

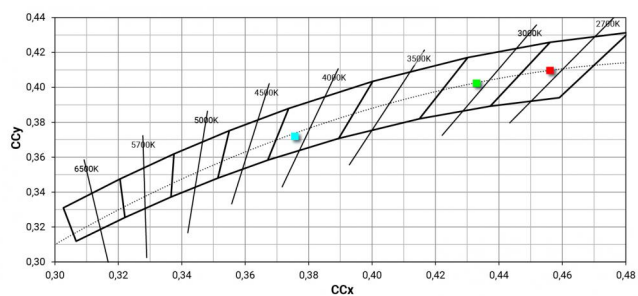
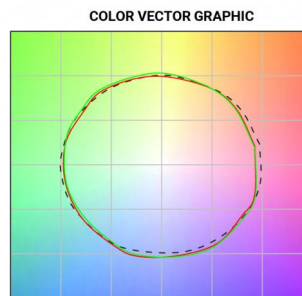
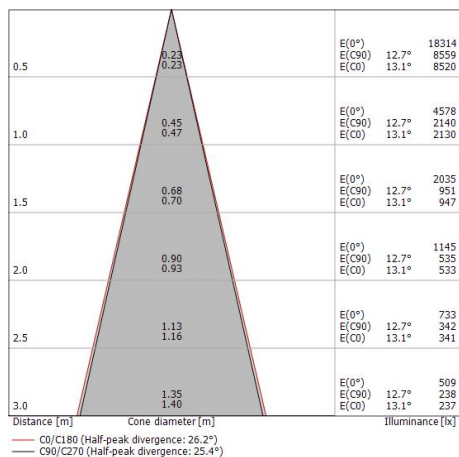
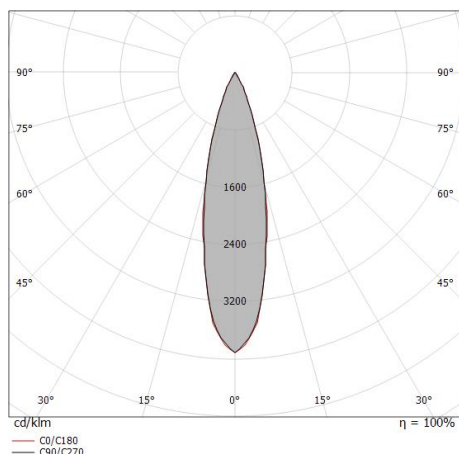

Pound_T | Projectors | Accessories
83803M30



Ottica
Distribuzione ottica: spot, Materiale rivestimento: policarbonato uv resistente

Code
99805



Ottica
Distribuzione ottica: medium flood, Materiale rivestimento: policarbonato uv resistente

Code
99806



Ottica
Distribuzione ottica: flood, Materiale rivestimento: policarbonato uv resistente

Code
99807



Antiabbagliamento
Tipo Antiabbagliamento: schermo cilindrico 45°.
Materiale: Pom-C, colore: Nero.

Code
99773

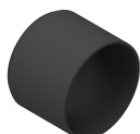

Antiabbagliamento
Tipo Antiabbagliamento: schermo cilindrico.
Materiale: Pom-C, colore: Nero.

Code
99774



Diffusore
Tipo diffusore: filtro ellittico.
Materiale: Pom-C, colore: Nero.

Code
99775



Antiabbagliamento
Tipo Antiabbagliamento: frangiluce nido d'ape.
Materiale: Pom-C, colore: Nero.

Code
99776

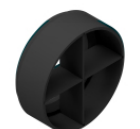

Antiabbagliamento
Tipo Antiabbagliamento: frangiluce a croce.
Materiale: Pom-C, colore: Nero.

Code
99777

Pound_T | Projectors | Accessories
83803M30

		<p>Binario</p> <p>Lunghezza: 1000mm; Tipo binario: Standard.</p> <p>Materiale:alluminio, colore:Text white (R9003), lavorazione:verniciatura.</p>	<p>Code</p> <p><u>83336</u></p>
		<p>Binario</p> <p>Lunghezza: 2000mm; Tipo binario: Standard.</p> <p>Materiale:alluminio, colore:Text white (R9003), lavorazione:verniciatura.</p>	<p>Code</p> <p><u>83337</u></p>
		<p>Binario - Binario Incassato Trifase DALI Bianco, 2 m (9000-2/W-R)</p> <p>Lunghezza: 2000mm; Tipo binario: Standard.</p> <p>Materiale:alluminio, colore:Text white (R9003), lavorazione:verniciatura.</p>	<p>Code</p> <p><u>80991</u></p>
		<p>Binario</p> <p>Lunghezza: 2000mm; Tipo binario: Standard.</p> <p>Materiale:alluminio, colore:Text black (R9005), lavorazione:verniciatura.</p>	<p>Code</p> <p><u>83340</u></p>
		<p>Binario - Binario Incassato Trifase DALI Nero, 3 m (9000-3/B-R)</p> <p>Lunghezza: 3000mm; Tipo binario: Standard.</p> <p>Materiale:alluminio, colore:Text black (R9005), lavorazione:verniciatura.</p>	<p>Code</p> <p><u>80995</u></p>
		<p>Power Supply - Testata di alimentazione destra bianca (9001/W)</p> <p>Materiale:polycarbonato, colore:Bianco .</p>	<p>Code</p> <p><u>81033</u></p>
		<p>Power Supply - Testata di alimentazione destra nera (9001/B)</p> <p>Materiale:polycarbonato, colore:Black.</p>	<p>Code</p> <p><u>81034</u></p>
		<p>Binario - Binario Incassato Trifase DALI Nero, 2 m (9000-2/B-R)</p> <p>Lunghezza: 2000mm; Tipo binario: Standard.</p> <p>Materiale:alluminio, colore:Text black (R9005), lavorazione:verniciatura.</p>	<p>Code</p> <p><u>80994</u></p>

Pound_T | Projectors | Accessories
83803M30

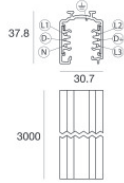

Binario

Lunghezza: 3000mm; Tipo binario: Standard.

Materiale: alluminio, colore: Text white (R9003), lavorazione: verniciatura.

Code

83338



Giunzione - Giunto di alimentazione nero - centrale (9010/B)

Tipologia linear.

Materiale: policarbonato, colore: Black.

Code

81043

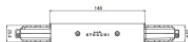

Giunzione - Giunto di alimentazione bianco - centrale (9010/W)

Tipologia linear.

Materiale: policarbonato, colore: Bianco .

Code

81042

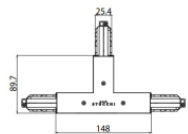

Giunzione - Giunto a T sinistro bianco - esterno (9013/W)

Tipologia linear.

Materiale: policarbonato, colore: Bianco .

Code

81051

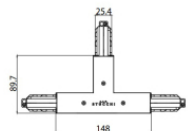

Giunzione - Giunto a T sinistro nero - esterno (9013/B)

Tipologia linear.

Materiale: policarbonato, colore: Black.

Code

81052

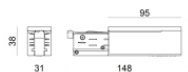

Power Supply - Testata di alimentazione sinistra bianca (9002/W)

Materiale: policarbonato, colore: Bianco .

Code

81036



Giunzione - Giunto flessibile bianco (9018/W)

Tipologia flexible curve.

Materiale: policarbonato, colore: Bianco .

Code

81066



Tappo - Tappo di chiusura bianco 9004/W

Materiale: policarbonato, colore: Bianco .

Code

80999

Pound_T | Projectors | Accessories
83803M30

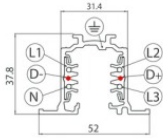

Binario - Binario Incassato Trifase DALI Bianco, 1 m (9000-1/W-R)
Lunghezza: 1000mm; Tipo binario: Standard.
Materiale: alluminio, colore: Text white (R9003), lavorazione: verniciatura.

Code
80990

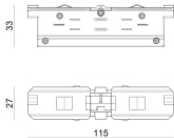

Giunzione - Giunto elettrico bianco - interno (9003/W)
Tipologia linear.
Materiale: policarbonato, colore: Bianco .

Code
81039

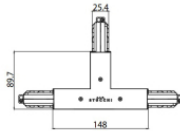

Giunzione - Giunto a T destro bianco - esterno (9014/W)
Tipologia linear.
Materiale: policarbonato, colore: Bianco .

Code
81054

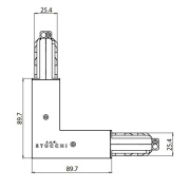

Giunzione - Giunto a L bianco - interno (9011/W)
Tipologia linear.
Materiale: policarbonato, colore: Bianco .

Code
81045

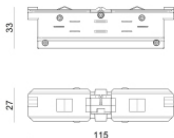

Giunzione - Giunto elettrico nero - interno (9003/B)
Tipologia linear.
Materiale: policarbonato, colore: Black.

Code
81040

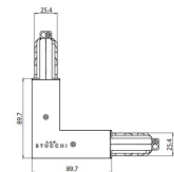

Giunzione - Giunto a L bianco - esterno (9012/W)
Tipologia linear.
Materiale: policarbonato, colore: Bianco .

Code
81048

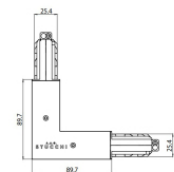

Giunzione - Giunto a L nero - esterno (9012/B)
Tipologia linear.
Materiale: policarbonato, colore: Black.

Code
81049



Tappo - Tappo di chiusura nero 9004/B
Materiale: policarbonato, colore: Black.

Code
81000

Pound_T | Projectors | Accessories
83803M30

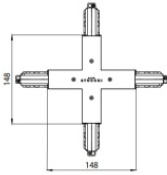
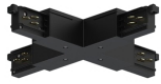

Giunzione - Giunto a X nero (9017/B)
Tipologia linear.
Materiale:policarbonato, colore:Black.

Code
81064

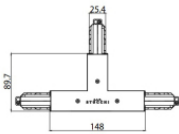

Giunzione - Giunto a T bianco sinistro - interno (9015/W)
Tipologia linear.
Materiale:policarbonato, colore:Bianco .

Code
81057

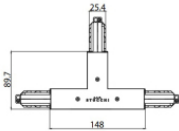

Giunzione - Giunto a T nero sinistro - interno (9015/B)
Tipologia linear.
Materiale:policarbonato, colore:Black.

Code
81058

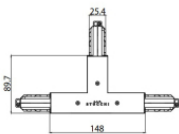

Giunzione - Giunto a T bianco destro - interno (9016/W)
Tipologia linear.
Materiale:policarbonato, colore:Bianco .

Code
81060

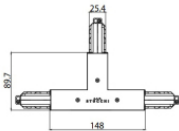

Giunzione - Giunto a T destro nero - interno (9016/B)
Tipologia linear.
Materiale:policarbonato, colore:Black.

Code
81061



Tappo - Tappo di chiusura bianco per incasso 9004-R/W
Materiale:policarbonato, colore:Bianco .

Code
81002



Tappo - Tappo di chiusura nero per incasso 9004-R/B
Materiale:policarbonato, colore:Black.

Code
81003



Rosone - Kit sospensione bianco 1.5m + staffa (9000-KIT5-1,5-W)
Driver incluso: No.
Materiale:plastica, colore:Bianco .

Code
81012

Pound_T | Projectors | Accessories
83803M30

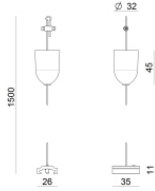

Rosone - Kit sospensione nero 1.5m + staffa (9000-KIT5-1,5-B)
Driver incluso: No.
Materiale:plastica, colore:Black.

Code
81014

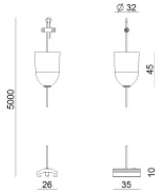

Rosone - Kit sospensione bianco 5m + staffa (9000-KIT5-5-W)
Driver incluso: No.
Materiale:plastica, colore:Bianco .

Code
81013

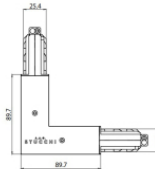

Giunzione - Giunto a L nero - interno (9011/B)
Tipologia linear.
Materiale:policarbonato, colore:Black.

Code
81046



Sospensioni - Sospensione rigida 1m bianca (S-9000-P3-W)
Materiale:plastica, colore:Bianco .

Code
81021



Sospensioni - Sospensione rigida 1m nera (S-9000-P3-B)
Materiale:plastica, colore:Black.

Code
81022



Staffa - Staffa anodizzata per fissaggio a soffitto (S-9000/131)
L=35mm, H=14mm, D=24mm.
Materiale:alluminio, colore:Polished aluminium.

Code
81086



Staffa - Staffa bianca per fissaggio a soffitto (S-9000/131-W)
L=35mm, H=14mm, D=24mm.
Materiale:alluminio, colore:Bianco , lavorazione:verniciatura.

Code
81087



Staffa - Staffa nera per fissaggio a soffitto (S-9000/131-B)
L=35mm, H=14mm, D=24mm.
Materiale:alluminio, colore:Text black (R9005), lavorazione:verniciatura.

Code
81088

Pound_T | Projectors | Accessories
83803M30

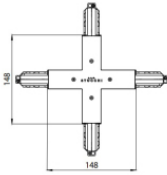
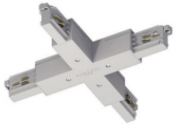

Giunzione - Giunto a X bianco (9017/W)
Tipologia linear.
Materiale:policarbonato, colore:Bianco .

Code
81063



Rosone - Kit sospensione nero 5m + staffa (9000-KIT5-5-B)
Driver incluso: No.
Materiale:plastica, colore:Black.

Code
81015



Coprifilo - Copertura per giunto L incassato bianco (S-9011-R/6-W)
Materiale:policarbonato, colore:Bianco .

Code
81075

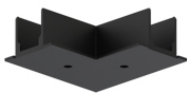

Coprifilo
Materiale:policarbonato, colore:Black.

Code
81076

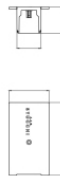

Coprifilo - Copertura per testata ad incasso nera (S-9001-R/6-B)
Materiale:policarbonato, colore:Black.

Code
81070

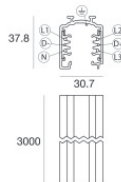

Binario
Lunghezza: 3000mm; Tipo binario: Standard.
Materiale:alluminio, colore:Text black (R9005), lavorazione:verniciatura.

Code
83341

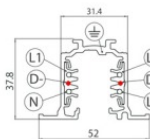

Binario - Binario Incassato Trifase DALI Bianco, 3 m (9000-3/W-R)
Lunghezza: 3000mm; Tipo binario: Standard.
Materiale:alluminio, colore:Text white (R9003), lavorazione:verniciatura.

Code
80992

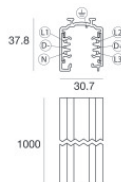









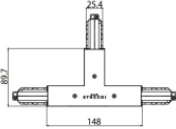

Binario
Lunghezza: 1000mm; Tipo binario: Standard.
Materiale:alluminio, colore:Text black (R9005), lavorazione:verniciatura.

Code
83339

Pound_T | Projectors | Accessories
83803M30

	<p>adattatore trifase nero (9009-4/B)</p>	Code 81093
	<p>Staffa - Staffa nera di irrigidimento (S-9000/333-B) L=180mm, H=24mm, D=20mm. Materiale:alluminio, colore:Nero RAL 9005, lavorazione:verniciatura.</p>	Code 81026
	<p>Power Supply - Testata di alimentazione sinistra nera (9002/B) Materiale:policarbonato, colore:Black.</p>	Code 81037
	<p>Binario - Binario Incassato Trifase DALI Nero, 1 m (9000-1/B-R) Lunghezza: 1000mm; Tipo binario: Standard. Materiale:alluminio, colore:Text black (R9005), lavorazione:verniciatura.</p>	Code 80993
	<p>Coprifilo - Copertura per giunto X incassato nero (S-9017-R/6-B) Materiale:policarbonato, colore:Black.</p>	Code 81082
	<p>Staffa - Staffa bianca di irrigidimento (S-9000/333-W) L=180mm, H=24mm, D=20mm. Materiale:alluminio, colore:Bianco RAL 9010, lavorazione:verniciatura.</p>	Code 81025
	<p>Coprifilo - Coperture per giunto T incassato bianco (S-9013-R/6-W) Materiale:policarbonato, colore:Bianco .</p>	Code 81078
	<p>Sospensioni - Clip per sospensione rigida bianca (S-9000-P2-W) Materiale:plastica, colore:Bianco .</p>	Code 81018

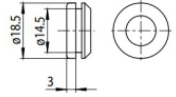
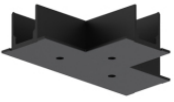
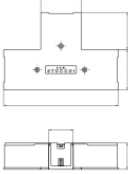
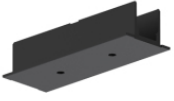
Pound_T | Projectors | Accessories
83803M30

	<p>Coprifilo Materiale:Nero , colore:Black.</p>	<p>Code <u>83250</u></p>	
	<p>Coprifilo Materiale:Bianco .</p>	<p>Code <u>83249</u></p>	
		<p>Giunzione - Giunto a T destro nero - esterno (9014/B) Tipologia linear. Materiale:policarbonato, colore:Black.</p>	<p>Code <u>81055</u></p>
		<p>Coprifilo - Copertura per giunto ad incasso bianco (S-9010-R/6-W) Materiale:policarbonato, colore:Bianco .</p>	<p>Code <u>81072</u></p>
		<p>Staffa - Staffa anodizzata di irrigidimento (S-9000/333) L=180mm, H=24mm, D=26mm. Materiale:alluminio, colore:Anodised aluminium, lavorazione:anodizzazione.</p>	<p>Code <u>81024</u></p>
		<p>Tappo - Guarnizione bianca (S-9001/115-W) Materiale:Bianco .</p>	<p>Code <u>81084</u></p>
		<p>Coprifilo - Copertura per giunti T incassato nero (S-9013-R/6-B) Materiale:policarbonato, colore:Black.</p>	<p>Code <u>81079</u></p>
		<p>Coprifilo - Copertura per giunto ad incasso nero (S-9010-R/6-B) Materiale:policarbonato, colore:Black.</p>	<p>Code <u>81073</u></p>

Pound_T | Projectors | Accessories
83803M30



Sospensioni - Kit sospensione bianco 1.5m (9000-KIT3-1,5-W)
Materiale:plastica, colore:Bianco .

Code
81006

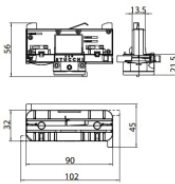

Adattatore trifase bianco (9009-4/W)

Code
81091

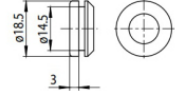

Tappo - Guarnizione nera (S-9001/115-B)
Materiale:Nero , colore:Black.

Code
81085

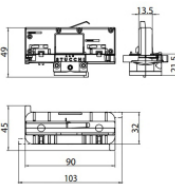

Adattatore trifase/DALI bianco (9009/W)

Code
81094

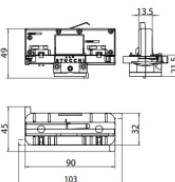

Adattatore trifase/DALI nero (9009/B)

Code
81095

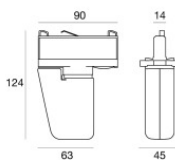

Accessorio elettronica - Controller TWIL-DALI per dispositivi con protocollo DALI installati su binario trifase.
posizione installativa: soffitto L=90mm, H=124mm, D=45mm.
Materiale:Plastica ABS, colore:Black.

Code
C-E700008

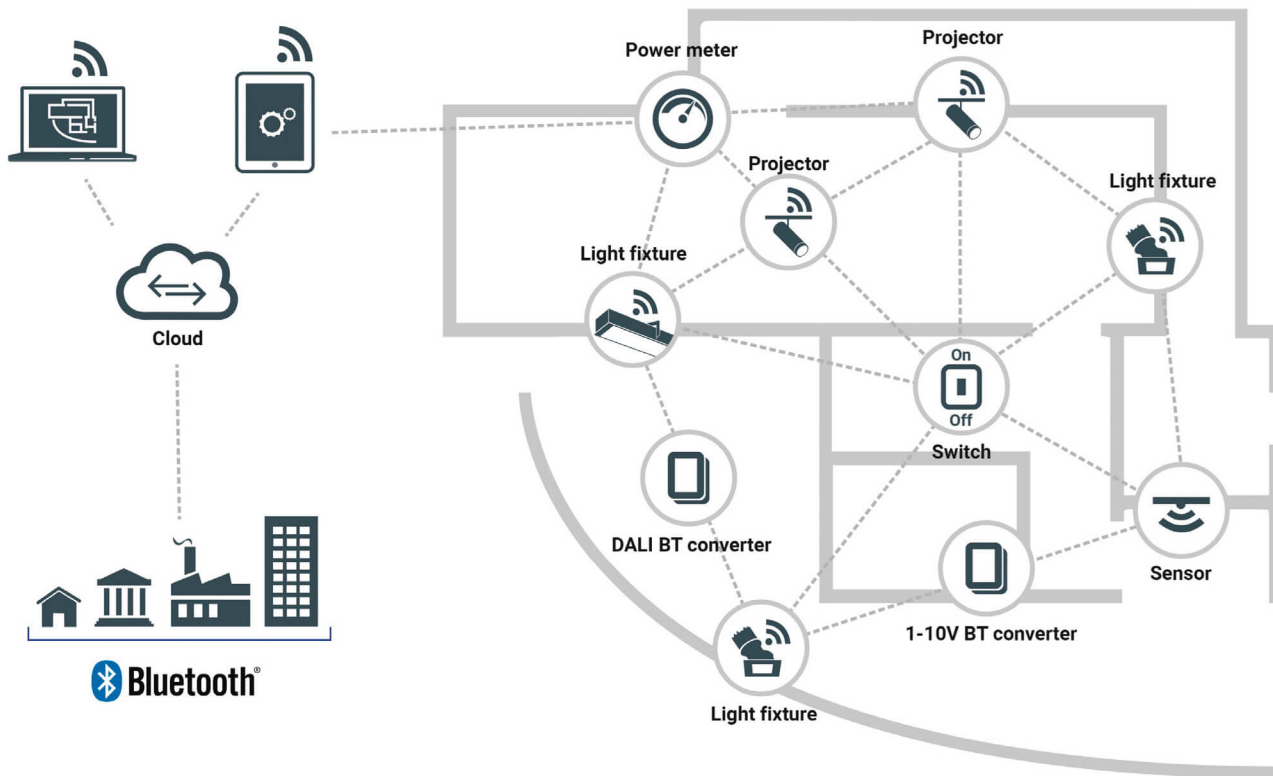

Identificazione dispositivo

Alla prima accensione del dispositivo e ogni volta che viene effettuato il reset, il sistema effettua l'identificazione della lampada. L'identificazione consiste in un'animazione definita "Attention event" con il 40% di luminosità per 500ms, 100% di luminosità per 500 ms. Anche il LED blu di stato effettua un lampeggio durante la fase di identificazione con 500ms ON/500ms OFF.

Ripristino delle impostazioni di fabbrica del dispositivo

Bluetooth – Factory reset for Bluetooth device Un ripristino delle impostazioni di fabbrica cambierà lo stato del modulo nella rete mesh da connesso a non connesso, ovvero tutte le impostazioni di rete andranno perse. Questa funzionalità è necessaria per ripristinare la connessione di un dispositivo dopo un comportamento imprevisto in cui si perde il controllo del dispositivo. Per effettuare il ripristino alle impostazioni di fabbrica dell'apparecchiatura Bluetooth è sufficiente portare a contatto un magnete al simbolo indicato nell'involucro contenente il modulo Bluetooth. Mettere a contatto il magnete per 5 secondi. Una volta effettuato il ripristino alle impostazioni di fabbrica, il sistema effettuerà un'identificazione del dispositivo.



Antenna

L'antenna è incorporata all'interno dell'articolo.

Lampeggio del LED

Il LED blu di stato posizionato nell'involucro contenente l'interfaccia Bluetooth effettua una serie di lampeggi a seconda dello stato in cui la lampada si trova.

Lampeggio veloce / lampeggio lento

Il LED effettua un lampeggio veloce se la lampada non è connessa alla rete (ogni 300ms) Il LED effettua un lampeggio lento se la lampada è connessa alla rete (ogni 2s)

Lampada non connessa

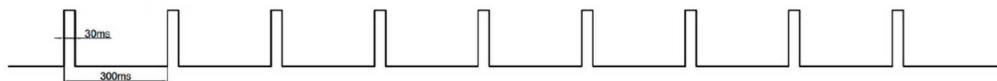

Lampada connessa



Lampeggio durante il reset alle impostazioni di fabbrica

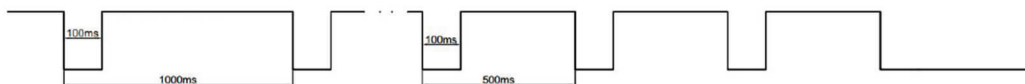

Ricevimento di un pacchetto mesh



Altre informazioni

- La portata wireless potrebbe essere influenzata, in modo particolare dalle superfici metalliche. In queste condizioni la portata wireless deve essere verificata.
- Se il dispositivo non è connesso ad una rete ci vorranno circa 30 secondi perché sia visualizzato come dispositivo disponibile dopo essere stato acceso.
- Il dispositivo ha superato con successo il processo di test SILVAIR
- Supporta gli switch EnOcean 83017
- Supporta i sensori Murata 83016
- Lo strumento può essere messo in funzione attraverso l'applicazione di messa in servizio SILVAR presente nell'app store del proprio smartphone o tablet.
- Per ulteriori informazioni consultare la guida SILVAIR al seguente link: <https://silvair.com/resources/product-documents/>
- Linea Light non avrà alcuna responsabilità per qualsiasi strumento di messa in servizio di terze parti e non fornisce alcuna dichiarazione, espressa o implicita, sulla disponibilità e / o sulle prestazioni di tale strumento di messa in servizio.

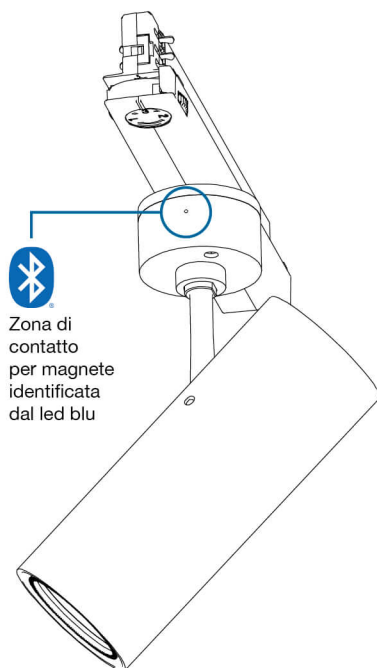
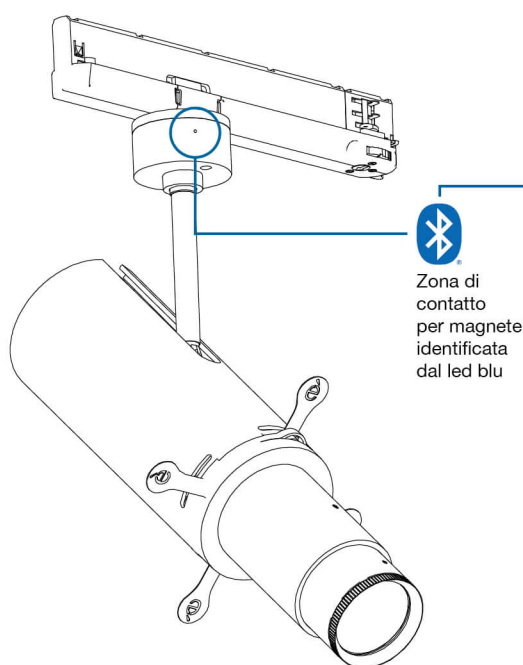
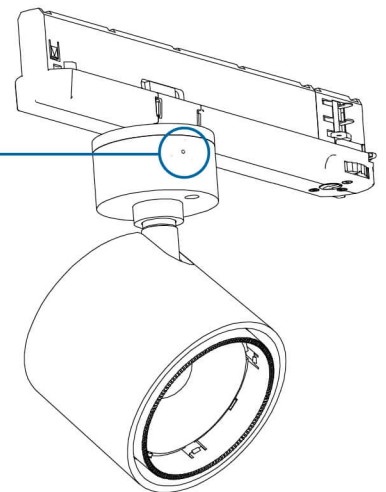
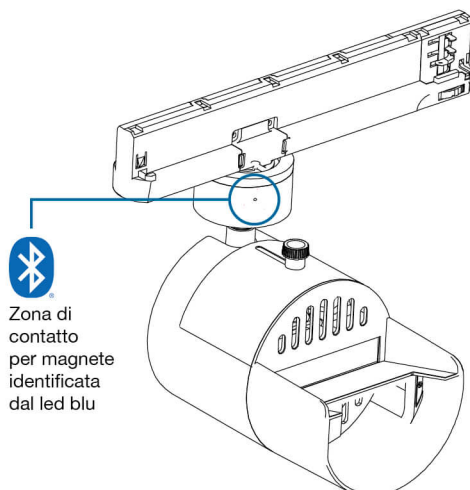
**POUND_T
POUND FOCUS****POUND SHAPER****OPTUS_T****OPTUS_Ww****Base
NAVATA OPTUS
NAVATA POUND
SHAPER**