

Proiettori | 176-264 V
1 arrayLED 27 W DC - 30 W AC | CRI 98
82113M66

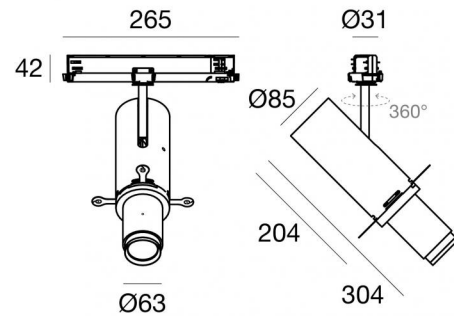

Dati tecnici	
Tipologia	Binario
Posizione installativa	Soffitto
Ambiente installativo	Indoor
Sorgente luminosa	Tecnologia LED
Struttura del circuito	arrayLED
Ottica	Shaper Medium Distance
Direzione emissione luminosa	frontale
Potenza nominale	27 W DC
Potenza totale	30 W
Flusso luminoso sorgente	2799 lm
Tensione nominale di ingresso	220 - 240 V AC
Range di tensione in ingresso	176 - 264 V AC
Frequenza	50 - 60 Hz
CCT / Tonalità	2700 K
Indice di resa cromatica	98 Ra
C.C. / C.V.	AC
Classe di isolamento	2
IP	IP20
Prova del filo incandescente	850°
Montaggio diretto su superfici normalmente infiammabili	Si
CE	Si
Driver incluso	Driver
Articolo dimmerabile	DALI-2 - PUSH DIM
Orientabilità	Orientabile
angolo totale (piano verticale)	90 °
angolo totale (piano orizzontale)	360 °
Basculante	No
Calpestabilità	No
Carrabilità	No
Cavo incluso	No
Resinatura	No
Tipologia di emissione luminosa	Singola emissione
Peso netto	1.5 Kg
Protezione scariche elettrostatiche	Si
Protezione surge	2 KV

Finitura Finitura corpo

Materiale	Alluminio Pressofuso EN AB - 46100
Colore	Text black (R9005)
Lavorazione	Verniciatura a polvere termoidurente

Proiettori | 176-264 V | 1 arrayLED 27 W DC - 30 W AC | CRI 98 | Base 82113M66

Proiettori a singola emissione per applicazione indoor. La sorgente luminosa LED, di colore bianco super caldo, con distribuzione luminosa Shaper Medium Distance, è composta da 1 LED arrayled, con una CCT 2700 K ed un CRI 98; il flusso luminoso della sorgente è di 2799 lm, con un'efficienza nominale di 103.7 lm/W.

Il corpo dell'apparecchio, realizzato in alluminio pressofuso en ab - 46100, presenta una finitura di colore text black (r9005), ottenuta tramite verniciatura a polvere termoindurente.

Il grado di protezione è IP20; il peso complessivo è di 1.5 kg.

La potenza assorbita dall'apparecchio è di 30 W

L'apparecchio presenta una classe di isolamento II ed è installabile a soffitto.

Conforme alla norma EN 60598-1 e alle relative prescrizioni particolari.

Classe di efficienza energetica

Questo prodotto contiene una sorgente luminosa di classe di efficienza energetica G.

Caratteristiche Illuminotecniche

Resa luminosa apparecchio (LOR)	18 %
Flusso luminoso sorgente	2799 lm
Flusso luminoso apparecchio	530 lm
Potenza reale apparecchio	30 W
Efficienza reale apparecchio	17 lm/W
Temperatura di colore	2700 K
Deviazione standard di corrispondenza colore	2 Step MacAdam
Indice di resa cromatica	98 Ra
Black Body Locus	On
Temperatura standard dell'ambiente di esercizio	-20 / +50°C
Temperatura tipica sul vetro	45°C

LED Life / Failure Ratio

L70 B10 C0 252000h (at Tj 65 Ta 25)

UGR

UGR axial	-4
UGR transversal	-4
X=4H Y=8H	S=0.25H
Reflection factor	70/50/20

OPTICAL

Ottica C0/C180	24°
Light distribution simmetry	Symmetrical

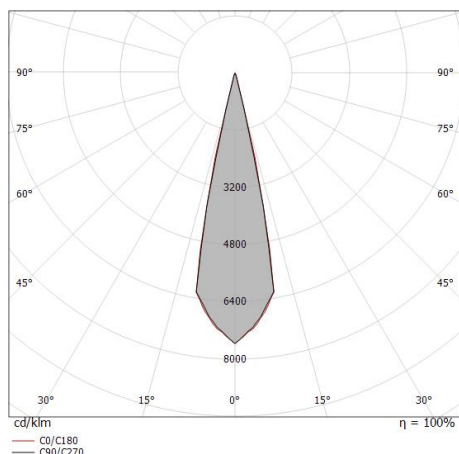

Distance [m]	Cone diameter [m]	illuminance [lx]
0.5	0.21 0.21	E(0°) 16022 E(C90) 7743 E(C0) 7529
1.0	0.42 0.43	E(0°) 4005 E(C90) 1936 E(C0) 1882
1.5	0.63 0.64	E(0°) 1780 E(C90) 860 E(C0) 837
2.0	0.84 0.85	E(0°) 1001 E(C90) 484 E(C0) 471
2.5	1.05 1.06	E(0°) 641 E(C90) 310 E(C0) 301
3.0	1.26 1.28	E(0°) 445 E(C90) 215 E(C0) 209

— C0/C180 (Half-peak divergence: 24.0°)
— C90/C270 (Half-peak divergence: 23.8°)

COLOR VECTOR GRAPHIC

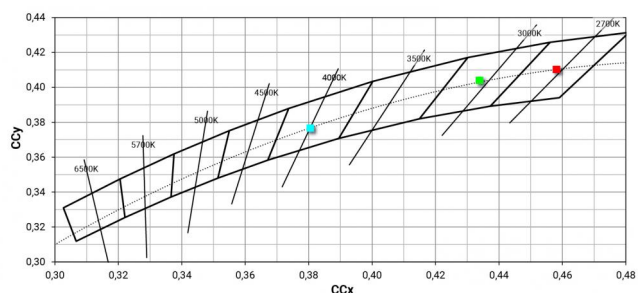
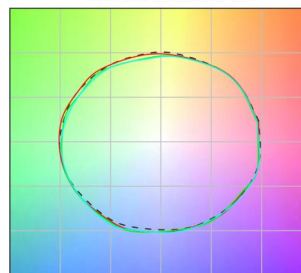

Pound_Shaper | Projectors | Accessories
82113M66



Power Supply - Testata di alimentazione destra bianca (9001/W)
 Materiale:policarbonato, colore:Bianco .

Code
81033

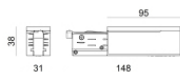

Power Supply - Testata di alimentazione sinistra bianca (9002/W)
 Materiale:policarbonato, colore:Bianco .

Code
81036

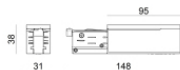

Power Supply - Testata di alimentazione sinistra nera (9002/B)
 Materiale:policarbonato, colore:Black.

Code
81037

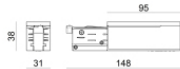

Power Supply - Testata di alimentazione destra nera (9001/B)
 Materiale:policarbonato, colore:Black.

Code
81034



Tappo - Tappo di chiusura bianco 9004/W
 Materiale:policarbonato, colore:Bianco .

Code
80999



Tappo - Tappo di chiusura nero 9004/B
 Materiale:policarbonato, colore:Black.

Code
81000



Tappo - Tappo di chiusura bianco per incasso 9004-R/W
 Materiale:policarbonato, colore:Bianco .

Code
81002



Tappo - Tappo di chiusura nero per incasso 9004-R/B
 Materiale:policarbonato, colore:Black.

Code
81003

Pound_Shaper | Projectors | Accessories
82113M66

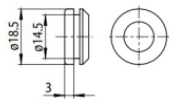

Tappo - Guarnizione bianca (S-9001/115-W)
Materiale: Bianco .

Code
81084

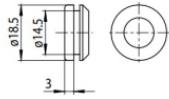

Tappo - Guarnizione nera (S-9001/115-B)
Materiale: Nero , colore: Black.

Code
81085



Rosone - Kit sospensione bianco 1.5m + staffa (9000-KIT5-1,5-W)
Driver incluso: No.
Materiale: plastica, colore: Bianco .

Code
81012

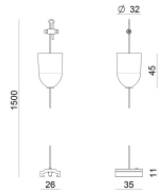

Rosone - Kit sospensione nero 1.5m + staffa (9000-KIT5-1,5-B)
Driver incluso: No.
Materiale: plastica, colore: Black.

Code
81014

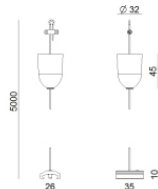

Rosone - Kit sospensione bianco 5m + staffa (9000-KIT5-5-W)
Driver incluso: No.
Materiale: plastica, colore: Bianco .

Code
81013



Rosone - Kit sospensione nero 5m + staffa (9000-KIT5-5-B)
Driver incluso: No.
Materiale: plastica, colore: Black.

Code
81015



Staffa - Staffa anodizzata per fissaggio a soffitto (S-9000/131)
L=35mm, H=14mm, D=24mm.
Materiale: alluminio, colore: Polished aluminium.

Code
81086



Staffa - Staffa anodizzata di irrigidimento (S-9000/333)
L=180mm, H=24mm, D=26mm.
Materiale: alluminio, colore: Anodised aluminium, lavorazione: anodizzazione.

Code
81024

Pound_Shaper | Projectors | Accessories
82113M66



Staffa - Staffa bianca di irrigidimento (S-9000/333-W)

L=180mm, H=24mm, D=20mm.

Materiale:alluminio, colore:Bianco RAL 9010, lavorazione:verniciatura.

Code

81025



Staffa - Staffa nera di irrigidimento (S-9000/333-B)

L=180mm, H=24mm, D=20mm.

Materiale:alluminio, colore:Nero RAL 9005, lavorazione:verniciatura.

Code

81026



Staffa - Staffa bianca per fissaggio a soffitto (S-9000/131-W)

L=35mm, H=14mm, D=24mm.

Materiale:alluminio, colore:Bianco , lavorazione:verniciatura.

Code

81087



Staffa - Staffa nera per fissaggio a soffitto (S-9000/131-B)

L=35mm, H=14mm, D=24mm.

Materiale:alluminio, colore:Text black (R9005), lavorazione:verniciatura.

Code

81088

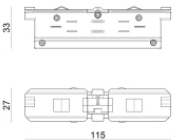

Giunzione - Giunto elettrico bianco - interno (9003/W)

Tipologia linear.

Materiale:policarbonato, colore:Bianco .

Code

81039

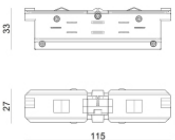

Giunzione - Giunto elettrico nero - interno (9003/B)

Tipologia linear.

Materiale:policarbonato, colore:Black.

Code

81040



Giunzione - Giunto di alimentazione bianco - centrale (9010/W)

Tipologia linear.

Materiale:policarbonato, colore:Bianco .

Code

81042

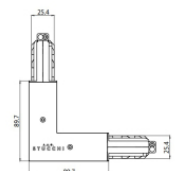

Giunzione - Giunto a L bianco - interno (9011/W)

Tipologia linear.

Materiale:policarbonato, colore:Bianco .

Code

81045

Pound_Shaper | Projectors | Accessories
82113M66

		<p>Giunzione - Giunto a L bianco - esterno (9012/W) Tipologia linear. Materiale:policarbonato, colore:Bianco .</p>	<p>Code <u>81048</u></p>
		<p>Giunzione - Giunto flessibile bianco (9018/W) Tipologia flexible curve. Materiale:policarbonato, colore:Bianco .</p>	<p>Code <u>81066</u></p>
		<p>Giunzione - Giunto a X bianco (9017/W) Tipologia linear. Materiale:policarbonato, colore:Bianco .</p>	<p>Code <u>81063</u></p>
		<p>Giunzione - Giunto a T sinistro bianco - esterno (9013/W) Tipologia linear. Materiale:policarbonato, colore:Bianco .</p>	<p>Code <u>81051</u></p>
		<p>Giunzione - Giunto a T destro bianco - esterno (9014/W) Tipologia linear. Materiale:policarbonato, colore:Bianco .</p>	<p>Code <u>81054</u></p>
		<p>Giunzione - Giunto a T bianco sinistro - interno (9015/W) Tipologia linear. Materiale:policarbonato, colore:Bianco .</p>	<p>Code <u>81057</u></p>
		<p>Giunzione - Giunto a T bianco destro - interno (9016/W) Tipologia linear. Materiale:policarbonato, colore:Bianco .</p>	<p>Code <u>81060</u></p>
		<p>Giunzione - Giunto di alimentazione nero - centrale (9010/B) Tipologia linear. Materiale:policarbonato, colore:Black.</p>	<p>Code <u>81043</u></p>

Pound_Shaper | Projectors | Accessories
82113M66

		<p>Giunzione - Giunto a L nero - interno (9011/B)</p> <p>Tipologia linear.</p> <p>Materiale:policarbonato, colore:Black.</p>	<p>Code 81046</p>
		<p>Giunzione - Giunto a L nero - esterno (9012/B)</p> <p>Tipologia linear.</p> <p>Materiale:policarbonato, colore:Black.</p>	<p>Code 81049</p>
		<p>Giunzione - Giunto flessibile nero (9018/B)</p> <p>Tipologia flexible curve.</p> <p>Materiale:policarbonato, colore:Black.</p>	<p>Code 81067</p>
		<p>Giunzione - Giunto a X nero (9017/B)</p> <p>Tipologia linear.</p> <p>Materiale:policarbonato, colore:Black.</p>	<p>Code 81064</p>
		<p>Giunzione - Giunto a T sinistro nero - esterno (9013/B)</p> <p>Tipologia linear.</p> <p>Materiale:policarbonato, colore:Black.</p>	<p>Code 81052</p>
		<p>Giunzione - Giunto a T destro nero - esterno (9014/B)</p> <p>Tipologia linear.</p> <p>Materiale:policarbonato, colore:Black.</p>	<p>Code 81055</p>
		<p>Giunzione - Giunto a T nero sinistro - interno (9015/B)</p> <p>Tipologia linear.</p> <p>Materiale:policarbonato, colore:Black.</p>	<p>Code 81058</p>
		<p>Giunzione - Giunto a T destro nero - interno (9016/B)</p> <p>Tipologia linear.</p> <p>Materiale:policarbonato, colore:Black.</p>	<p>Code 81061</p>

Pound_Shaper | Projectors | Accessories
82113M66



Sospensioni - Kit sospensione bianco 1.5m (9000-KIT3-1,5-W)
Materiale:plastica, colore:Bianco .

Code
81006



Sospensioni - Kit sospensione bianco 5m (9000-KIT3-5-W)
Materiale:plastica, colore:Bianco .

Code
81007



Sospensioni - Kit sospensione nero 1.5m (9000-KIT3-1,5-B)
Materiale:plastica, colore:Black.

Code
81008



Sospensioni - Kit sospensione nero 5m (9000-KIT3-5-B)
Materiale:plastica, colore:Black.

Code
81009



Sospensioni - Clip per sospensione rigida bianca (S-9000-P2-W)
Materiale:plastica, colore:Bianco .

Code
81018



Sospensioni - Clip per sospensione rigida nera (S-9000-P2-B)
Materiale:plastica, colore:Black.

Code
81019



Sospensioni - Sospensione rigida 1m bianca (S-9000-P3-W)
Materiale:plastica, colore:Bianco .

Code
81021



Sospensioni - Sospensione rigida 1m nera (S-9000-P3-B)
Materiale:plastica, colore:Black.

Code
81022

Pound_Shaper | Projectors | Accessories
82113M66

		Coprifilo - Copertura per testata ad incasso bianca (S-9001-R/6-W) Materiale:policarbonato, colore:Bianco .	Code <u>81069</u>
		Coprifilo - Copertura per giunto ad incasso bianco (S-9010-R/6-W) Materiale:policarbonato, colore:Bianco .	Code <u>81072</u>
		Coprifilo - Copertura per giunto L incassato bianco (S-9011-R/6-W) Materiale:policarbonato, colore:Bianco .	Code <u>81075</u>
		Coprifilo - Coperture per giunto T incassato bianco (S-9013-R/6-W) Materiale:policarbonato, colore:Bianco .	Code <u>81078</u>
		Coprifilo - Copertura per giunto X bianco (S-9017-R/6-W) Materiale:policarbonato, colore:Bianco .	Code <u>81081</u>
		Coprifilo - Copertura per testata ad incasso nera (S-9001-R/6-B) Materiale:policarbonato, colore:Black.	Code <u>81070</u>
		Coprifilo - Copertura per giunto ad incasso nero (S-9010-R/6-B) Materiale:policarbonato, colore:Black.	Code <u>81073</u>
		Coprifilo Materiale:policarbonato, colore:Black.	Code <u>81076</u>

Pound_Shaper | Projectors | Accessories
82113M66

		<p>Coprifilo - Copertura per giunti T incassato nero (S-9013-R/6-B) Materiale:policarbonato, colore:Black.</p>	<p>Code 81079</p>
		<p>Coprifilo - Copertura per giunto X incassato nero (S-9017-R/6-B) Materiale:policarbonato, colore:Black.</p>	<p>Code 81082</p>
		<p>Coprifilo Materiale:Bianco .</p>	<p>Code 83249</p>
		<p>Coprifilo Materiale:Nero , colore:Black.</p>	<p>Code 83250</p>
		<p>Adattatore trifase/DALI bianco (9009/W)</p>	<p>Code 81094</p>
		<p>Adattatore trifase bianco (9009-4/W)</p>	<p>Code 81091</p>
		<p>Adattatore trifase/DALI nero (9009/B)</p>	<p>Code 81095</p>
		<p>adattatore trifase nero (9009-4/B)</p>	<p>Code 81093</p>

Pound_Shaper | Projectors | Accessories
82113M66



Utensile - Tranchese S-9000/T
Materiale:gomma, colore:Black.

Code
81005



Utensile - Accessorio porta gobo
Materiale:alluminio, colore:Black, lavorazione:anodizzazione.

Code
99853

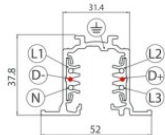

Binario - Binario Incassato Trifase DALI Bianco, 1 m (9000-1/W-R)
Lunghezza: 1000mm; Tipo binario: Standard.
Materiale:alluminio, colore:Text white (R9003), lavorazione:verniciatura.

Code
80990

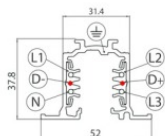

Binario - Binario Incassato Trifase DALI Bianco, 2 m (9000-2/W-R)
Lunghezza: 2000mm; Tipo binario: Standard.
Materiale:alluminio, colore:Text white (R9003), lavorazione:verniciatura.

Code
80991

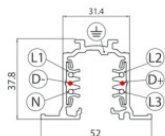

Binario - Binario Incassato Trifase DALI Bianco, 3 m (9000-3/W-R)
Lunghezza: 3000mm; Tipo binario: Standard.
Materiale:alluminio, colore:Text white (R9003), lavorazione:verniciatura.

Code
80992

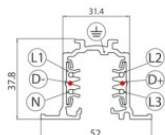

Binario - Binario Incassato Trifase DALI Nero, 1 m (9000-1/B-R)
Lunghezza: 1000mm; Tipo binario: Standard.
Materiale:alluminio, colore:Text black (R9005), lavorazione:verniciatura.

Code
80993

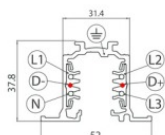

Binario - Binario Incassato Trifase DALI Nero, 2 m (9000-2/B-R)
Lunghezza: 2000mm; Tipo binario: Standard.
Materiale:alluminio, colore:Text black (R9005), lavorazione:verniciatura.

Code
80994

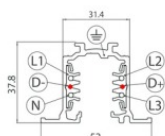

Binario - Binario Incassato Trifase DALI Nero, 3 m (9000-3/B-R)
Lunghezza: 3000mm; Tipo binario: Standard.
Materiale:alluminio, colore:Text black (R9005), lavorazione:verniciatura.

Code
80995

Pound_Shaper | Projectors | Accessories
82113M66

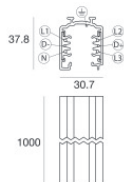

Binario

Lunghezza: 1000mm; Tipo binario: Standard.

Materiale:alluminio, colore:Text white (R9003), lavorazione:verniciatura.

Code

83336

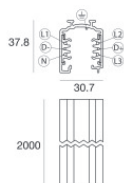

Binario

Lunghezza: 2000mm; Tipo binario: Standard.

Materiale:alluminio, colore:Text white (R9003), lavorazione:verniciatura.

Code

83337

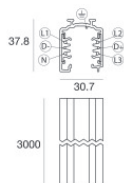

Binario

Lunghezza: 3000mm; Tipo binario: Standard.

Materiale:alluminio, colore:Text white (R9003), lavorazione:verniciatura.

Code

83338

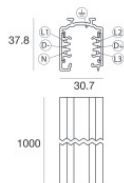

Binario

Lunghezza: 1000mm; Tipo binario: Standard.

Materiale:alluminio, colore:Text black (R9005), lavorazione:verniciatura.

Code

83339

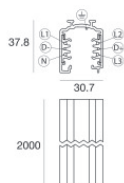

Binario

Lunghezza: 2000mm; Tipo binario: Standard.

Materiale:alluminio, colore:Text black (R9005), lavorazione:verniciatura.

Code

83340

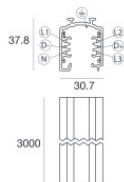

Binario

Lunghezza: 3000mm; Tipo binario: Standard.

Materiale:alluminio, colore:Text black (R9005), lavorazione:verniciatura.

Code

83341