





 CZ150DWWMDI

 CZ150DVBM DI

 CZ150DVDMDI

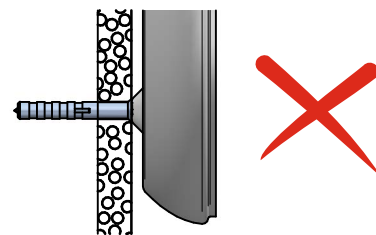
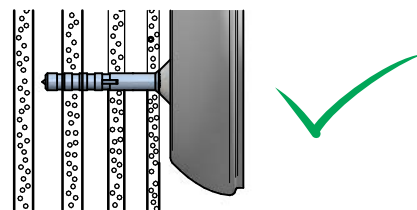
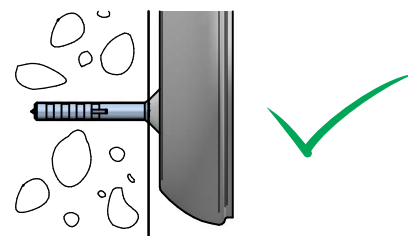
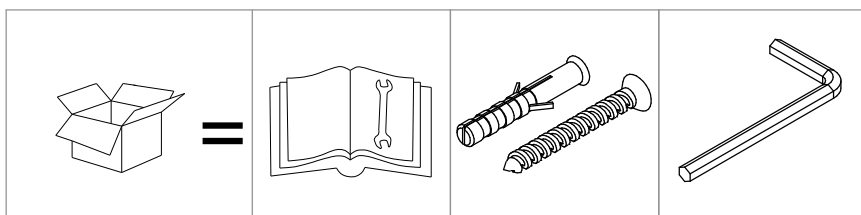
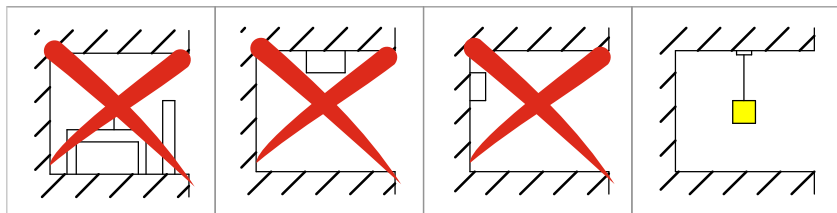
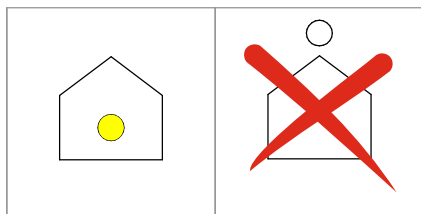

ATTENZIONE
PER L'INSTALLAZIONE E UTILIZZO DELL'APPARECCHIO
ATTENERSI ALLE ISTRUZIONI DI SEGUITO.
QUALSIASI VARIANTE DEVE ESSERE CONCORDATA
CON L'AZIENDA PER NON PERDERE LA GARANZIA

1

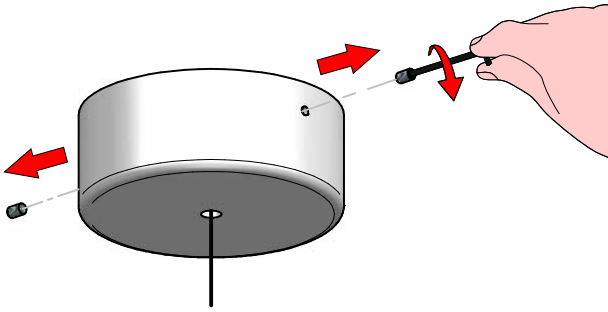

2

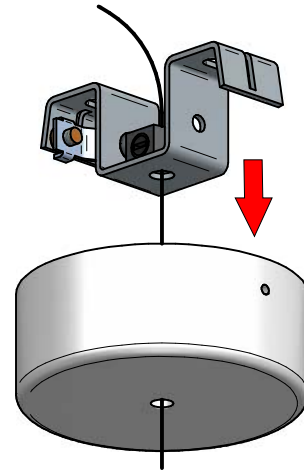

3

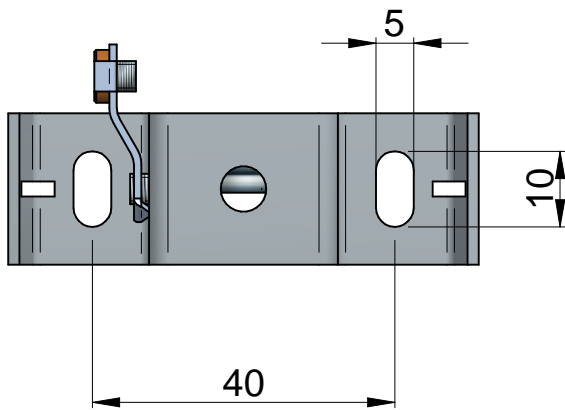

4

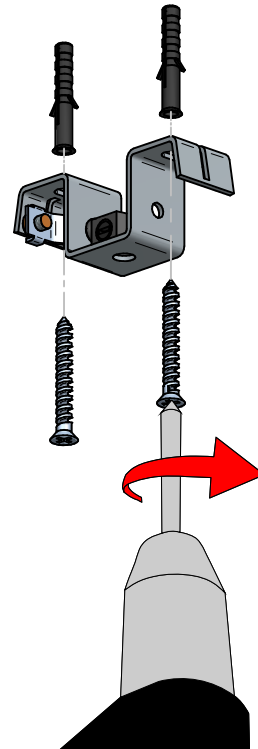

5

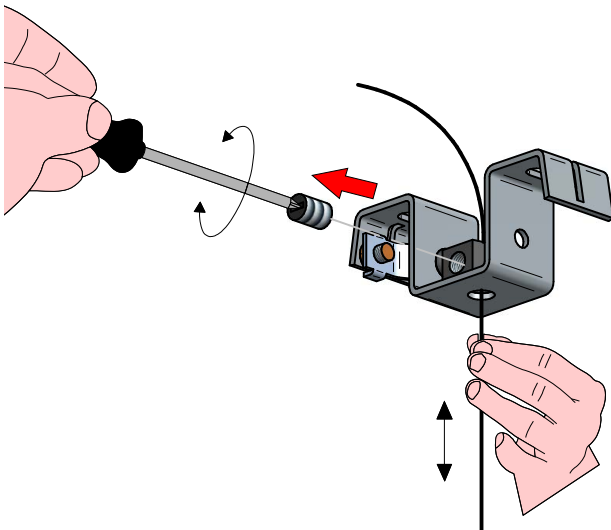

6

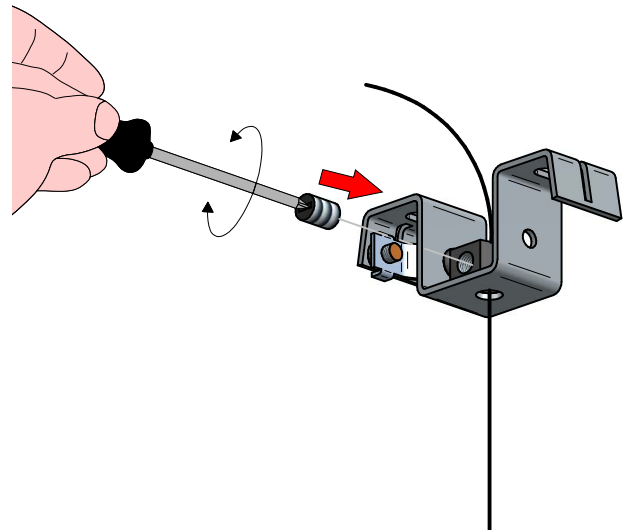

7

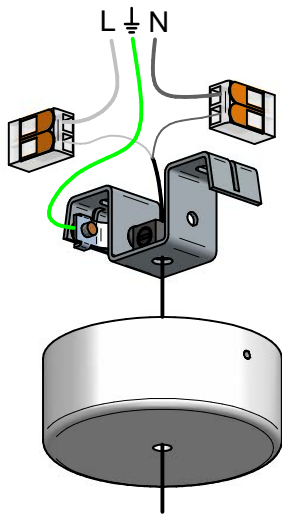

8

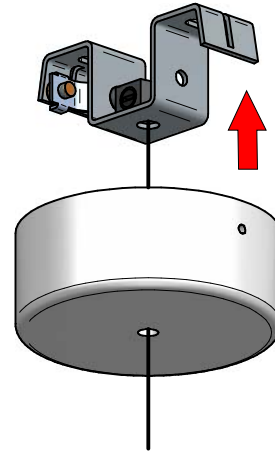

9

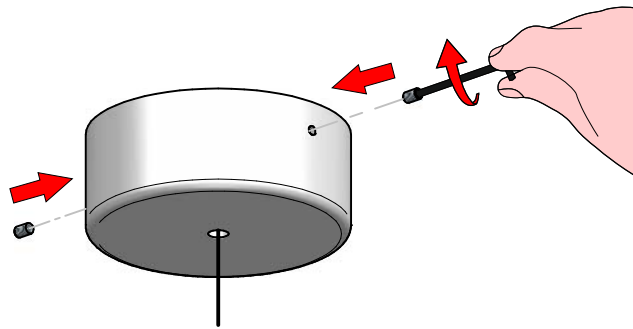

10

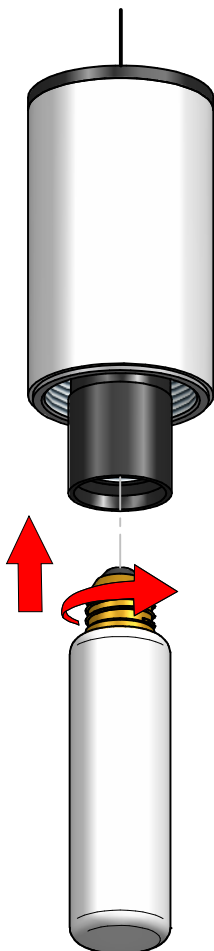

11

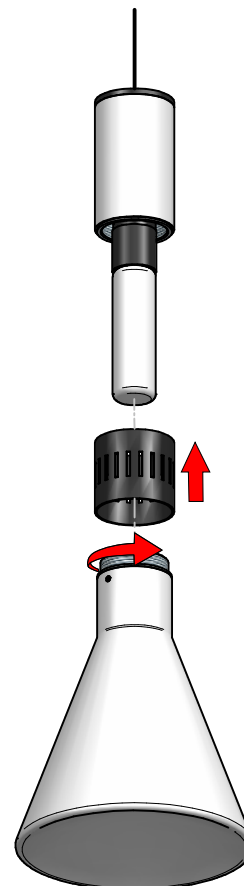

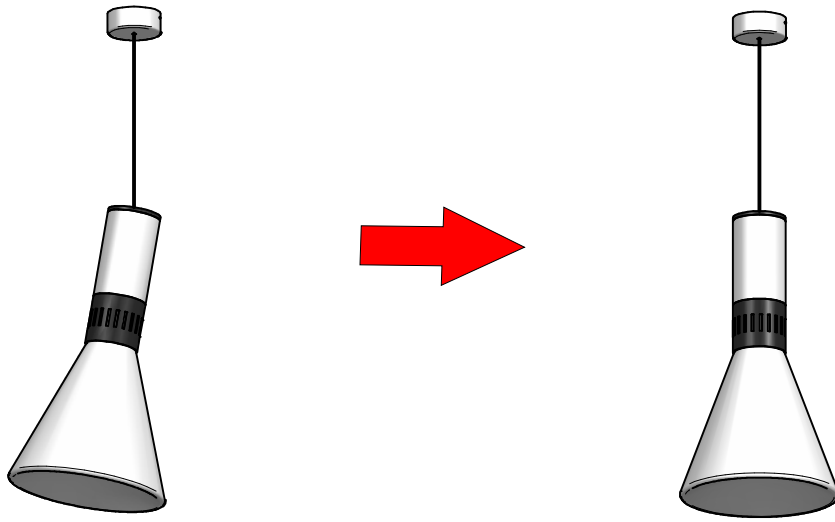

1

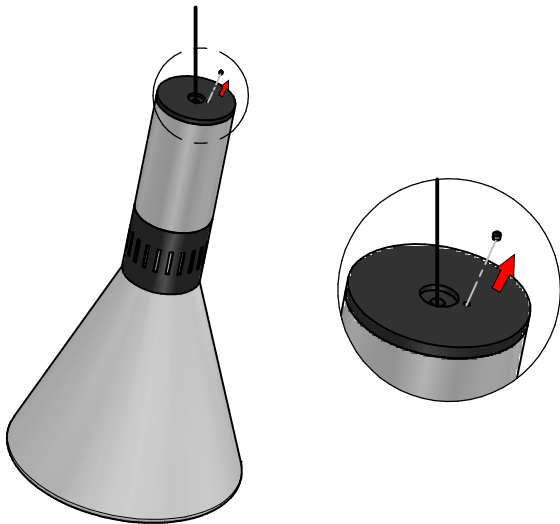

2

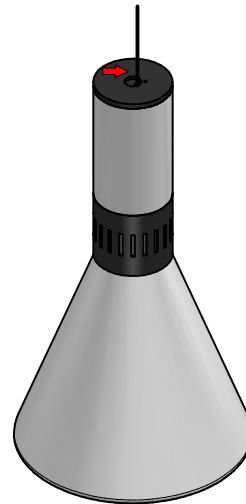

3

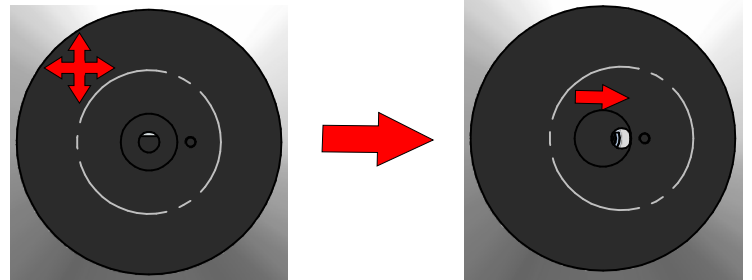
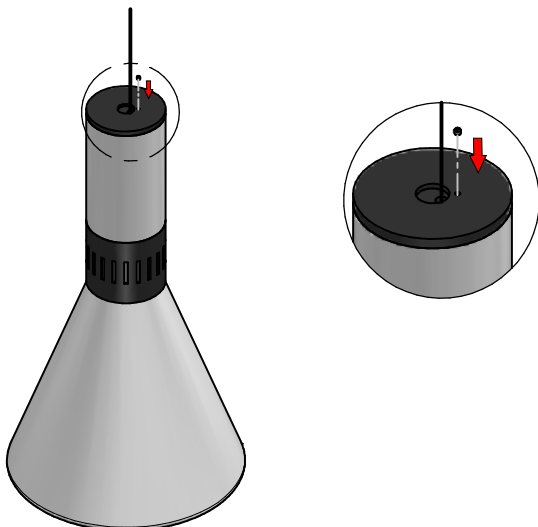

ISTRUZIONI PER IL LAVAGGIO DELL'APPARECCHIO D'ILLUMINAZIONE
LUMINAIRE CARE INSTRUCTIONS
ISTRUCCIONES PARA LIMPIAR LA LUMINARA
INSTRUCTIONS POUR LE LAVAGE DE L'APPAREIL D'ECLAIRAGE
ANLEITUNG ZUR REINIGUNG DES BELEUCHTUNGSGERATS

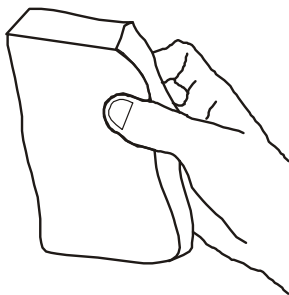
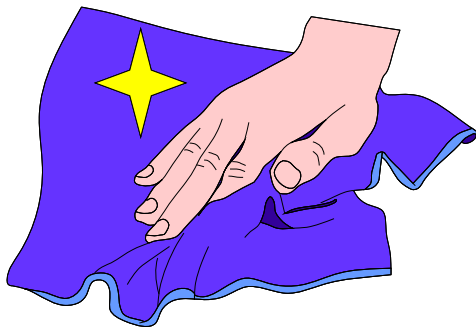

IT - ATTENZIONE!!!

Lavare la superficie della lampada con panno umido, utilizzando solo acqua e sapone neutro.

EN - WARNING!!!

Wipe clean with a cloth dampened in water with neutral detergent.

ES - ATENCION!!!

Limpie la superficie de la l mpara con un pano humedecido con agua y jabon neutro.

FR - ATTENTION!!!

Laver la surface de la lampe a l'aide d'un chiffon humide et en utilisant seulement de l'eau et du savon neutre.

DE - ACHTUNG!!!

Die Lampenoberfl che mit einem feuchten lappen reinigen. De lappen mit wasser und neutralseife befeuchten.

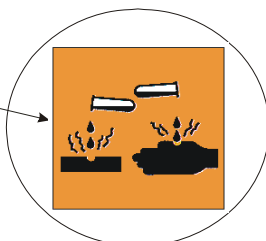
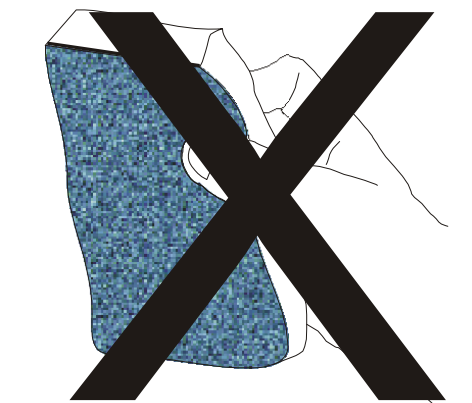

IT - ATTENZIONE!!!

Non utilizzare panni abrasivi e/o solventi.

EN - WARNING!!!

Avoiding the use of chemical solvents and/or abrasive cloths.

ES - ATENCION!!!

No utilizar panos abrasivos y solventes.

FR - ATTENTION!!!

Ne pas utiliser de chiffons abrasifs ou de dissolvants.

DE - ACHTUNG!!!

Abschleifende tuche und/oder losungsmittel nicht benutzen.