

D

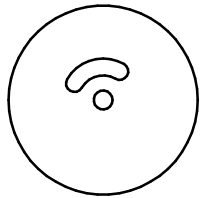

E

Assembly



OK

Assembly

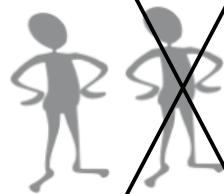

NOT OK

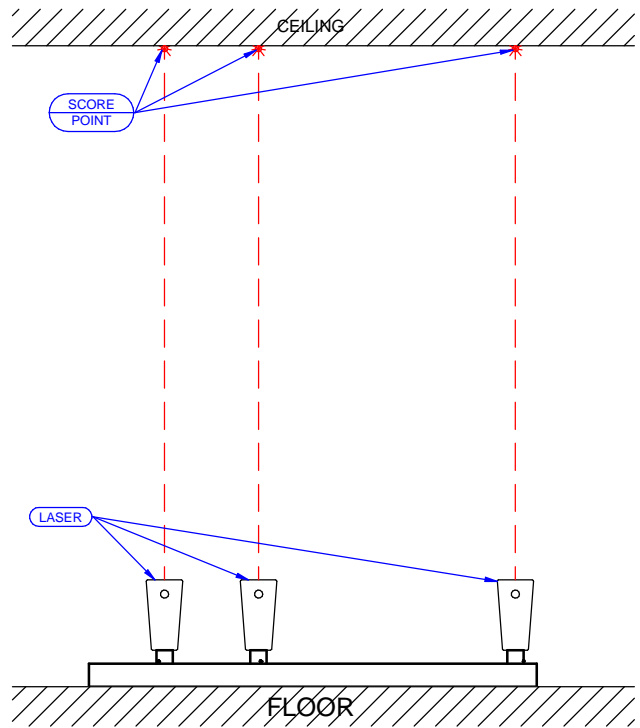

1

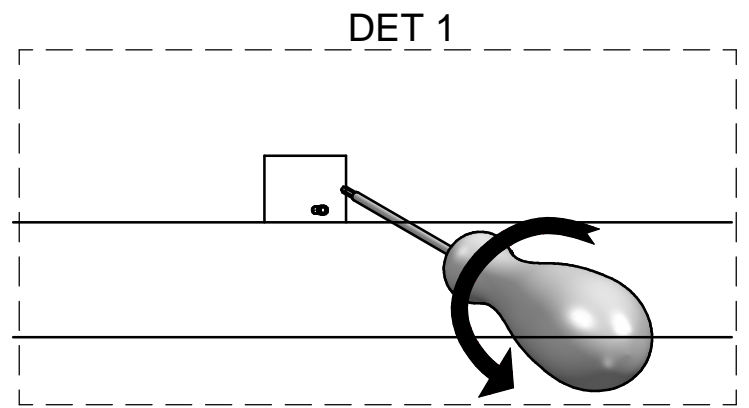
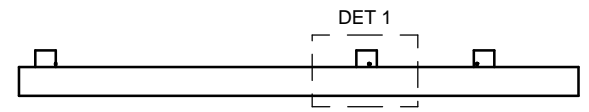

2

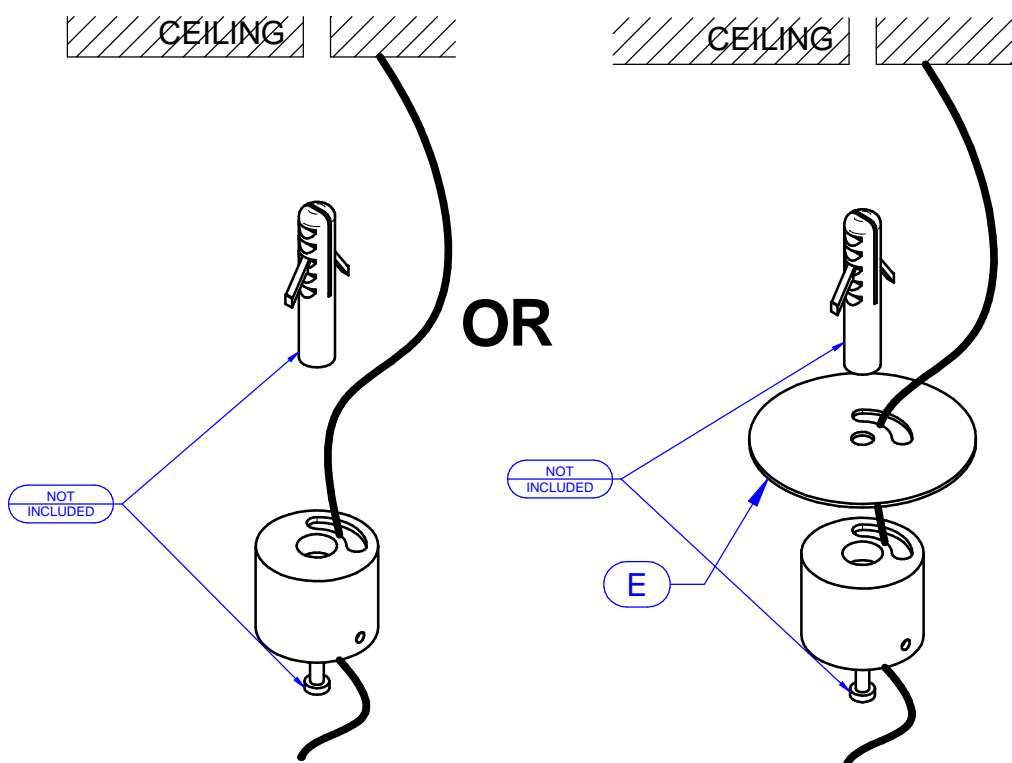

3

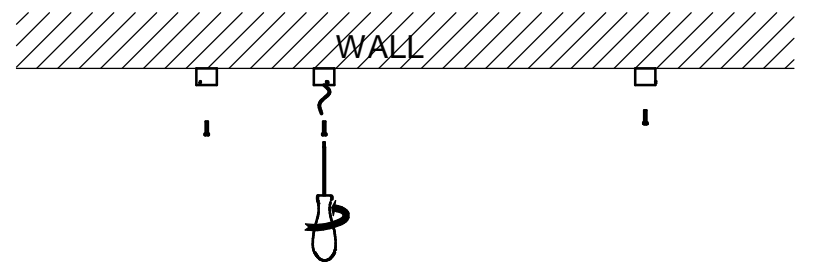

CORRECT ASSEMBLY

WRONG ASSEMBLY

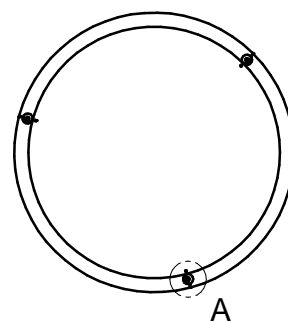

A

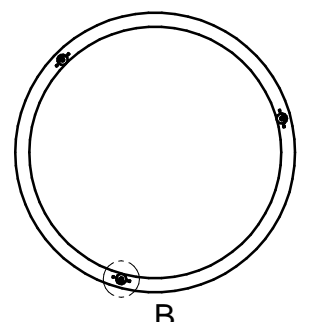

B

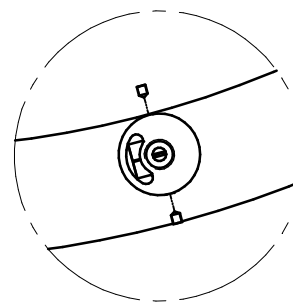

DETTAGLIO A

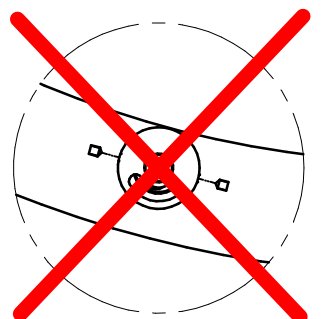

DETTAGLIO B

4

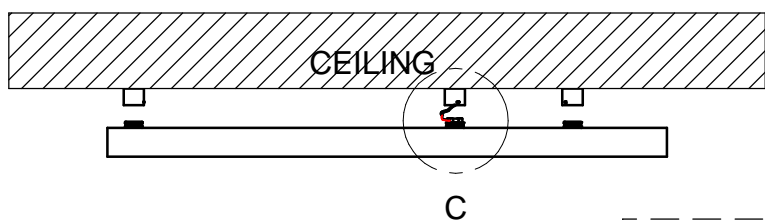

C

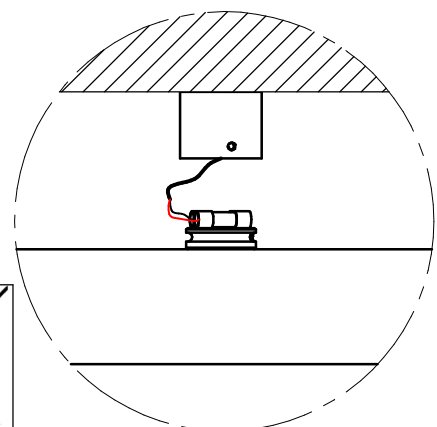

DETTAGLIO C

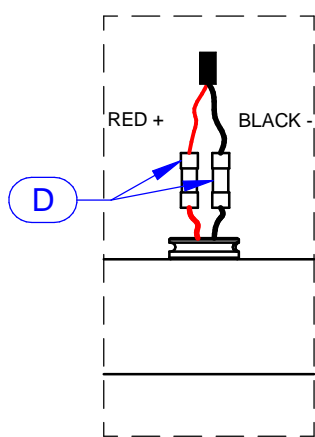

D

5

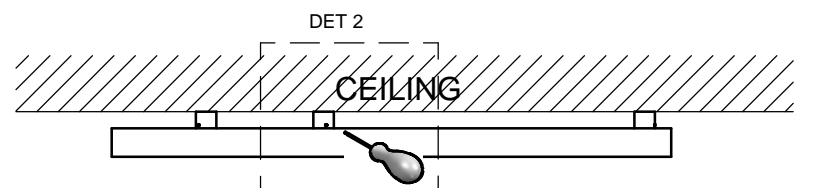

DET 2

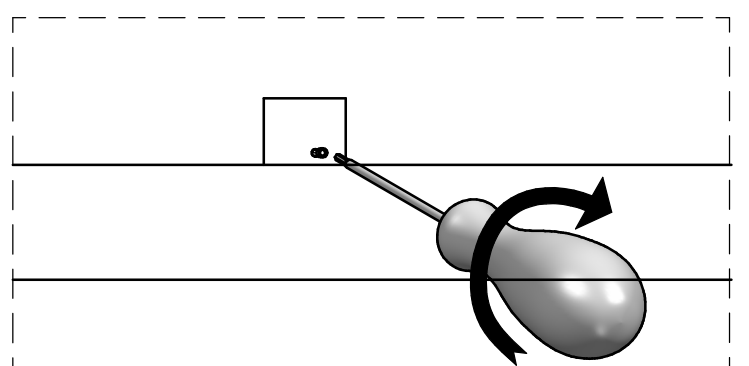

6



