

| Code | Length | Type |
|-------------|--------|----------------|
| C00126WHADI | 1m | 2200K |
| C00126WHMDI | 1m | 2700K |
| C00126WHWDI | 1m | 3000K |
| C00126WHTDI | 1m | 3500K |
| C00126WHNDI | 1m | 4000K |
| C00126WHDDI | 1m | Dynamic white |
| C00126WHVDI | 1m | RGBW |
| C00126CCWDI | 1m | 3000K concrete |

| Code | Length | Type |
|-------------|--------|----------------|
| C00127WHADI | 5m | 2200K |
| C00127WHMDI | 5m | 2700K |
| C00127WHWDI | 5m | 3000K |
| C00127WHTDI | 5m | 3500K |
| C00127WHNDI | 5m | 4000K |
| C00127WHDDI | 5m | Dynamic white |
| C00127WHVDI | 5m | RGBW |
| C00127CCWDI | 5m | 3000K Concrete |

| Code | Length | Type |
|-------------|--------|----------------|
| C00128WHADI | 10m | 2200K |
| C00128WHMDI | 10m | 2700K |
| C00128WHWDI | 10m | 3000K |
| C00128WHTDI | 10m | 3500K |
| C00128WHNDI | 10m | 4000K |
| C00128CCWDI | 10m | 3000K Concrete |

| Rubber 5W/M | | | |
|-------------|-----------|-----------|---------------|
| Code | CCT code | Type | Rubber length |
| C0013 | A (2200k) | DI-ffused | 67 - 10004 mm |
| | M (2700k) | | 67 - 10004 mm |
| | W (3000k) | | 67 - 10004 mm |
| | T (3500k) | | 67 - 10004 mm |
| | N (4000k) | | 67 - 10004 mm |

| Rubber 10W/M | | | |
|--------------|-----------|-----------|---------------|
| Code | CCT code | Type | Rubber length |
| C0014 | A (2200k) | DI-ffused | 67 - 10004 mm |
| | M (2700k) | | 67 - 10004 mm |
| | W (3000k) | | 67 - 10004 mm |
| | T (3500k) | | 67 - 10004 mm |
| | N (4000k) | | 67 - 10004 mm |

| Rubber RGBW/DYNAMIC | | | |
|---------------------|-------------------------|-----------|---------------|
| Code | CCT code | Type | Rubber length |
| C0014 | V (RGBW) | DI-ffused | 67 - 5004 mm |
| | D (DYNAMIC) (2000-6000) | | 67 - 5004 mm |

| Rubber 10W/M Concrete | | | |
|-----------------------|-----------|-----------|---------------|
| Code | CCT code | Type | Rubber length |
| C0017 | W (3000k) | DI-ffused | 67 - 10004 mm |

| Rubber 15W/M | | | |
|--------------|-----------|-----------|---------------|
| Code | CCT code | Type | Rubber length |
| C0015 | A (2200k) | DI-ffused | 67 - 10004 mm |
| | M (2700k) | | 67 - 10004 mm |
| | W (3000k) | | 67 - 10004 mm |
| | T (3500k) | | 67 - 10004 mm |
| | N (4000k) | | 67 - 10004 mm |

ATTENZIONE
PER L'INSTALLAZIONE E UTILIZZO DELL'APPARECCHIO ATTENERSI ALLE ISTRUZIONI DI SEGUITO. QUALSIASI VARIANTE DEVE ESSERE CONCORDATA CON L'AZIENDA PER NON PERDERE LA GARANZIA

ATTENTION
FOR INSTALLATION AND USE OF THE APPLIANCE, FOLLOW THE INSTRUCTIONS BELOW. ANY VARIANTS MUST BE AGREED ON WITH THE COMPANY TO PREVENT VOIDING THE WARRANTY.

ATTENTION
POUR L'INSTALLATION ET L'UTILISATION DE L'APPAREIL, SUIVEZ LES INSTRUCTIONS CI-DESSOUS. TOUT ACCORD AVEC L'ENTREPRISE POUR TOUTE VARIATION DOIT ÊTRE ACCEPTÉ AFIN D'ÉVITER L'ANNULATION DE LA GARANTIE.

AUFMERKSAMKEIT
BEFOLGEN SIE FÜR DIE INSTALLATION UND BENUTZUNG DES GERÄTS DIE UNTENSTEHENDEN ANWEISUNGEN. ALLE ABWEICHUNGEN MÜSSEN MIT DEM UNTERNEHMEN ABGESEHEN WERDEN, DAMIT DIE GARANTIE NICHT ERLISCHT.

ATENCIÓN
PARA LA INSTALACIÓN Y EL USO DEL APARATO, SIGA LAS INSTRUCCIONES A CONTINUACIÓN. CUALQUIER VARIANTE DEBE ACORDARSE CON LA EMPRESA PARA EVITAR LA ANULACIÓN DE LA GARANTÍA.

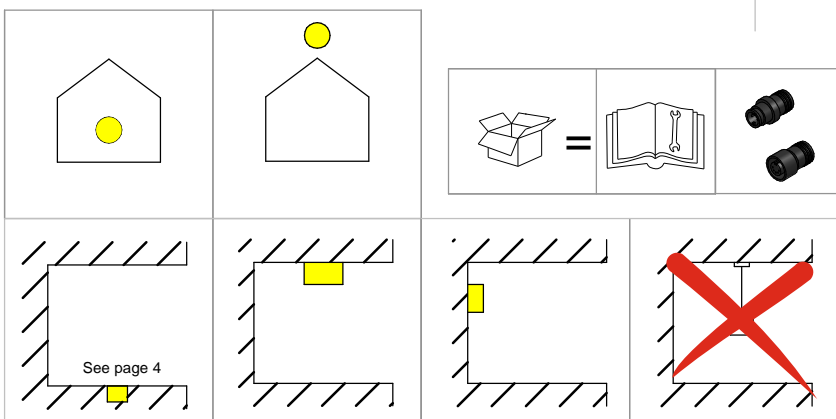

1

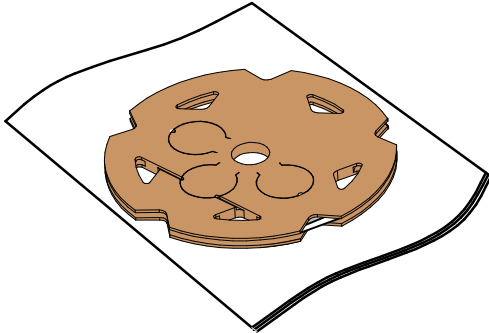

2

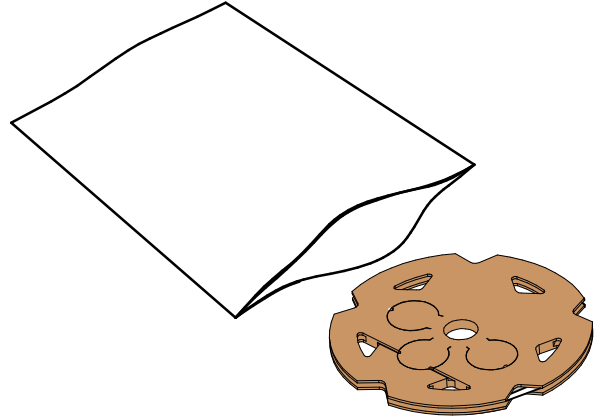

3

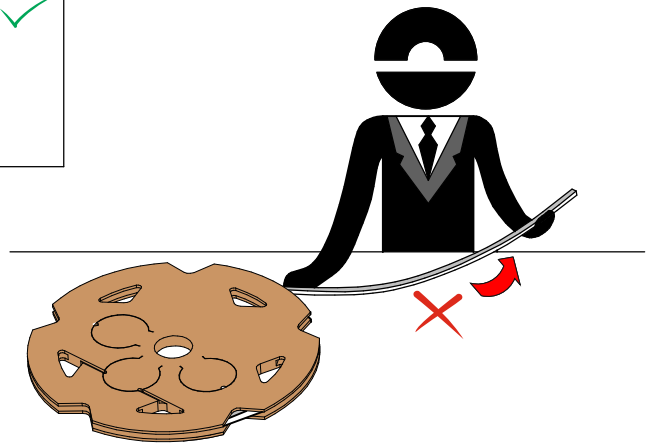
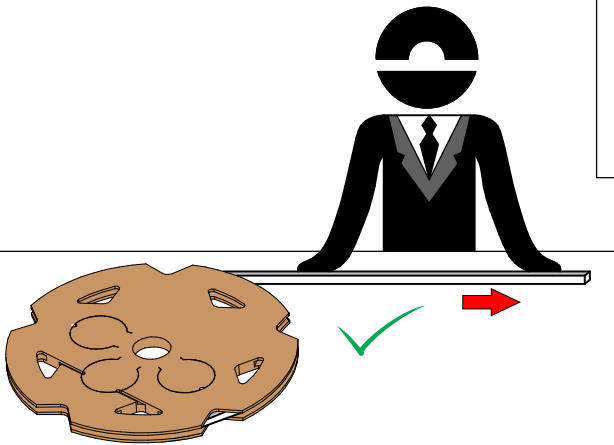
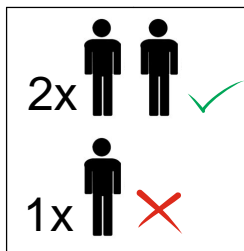

4

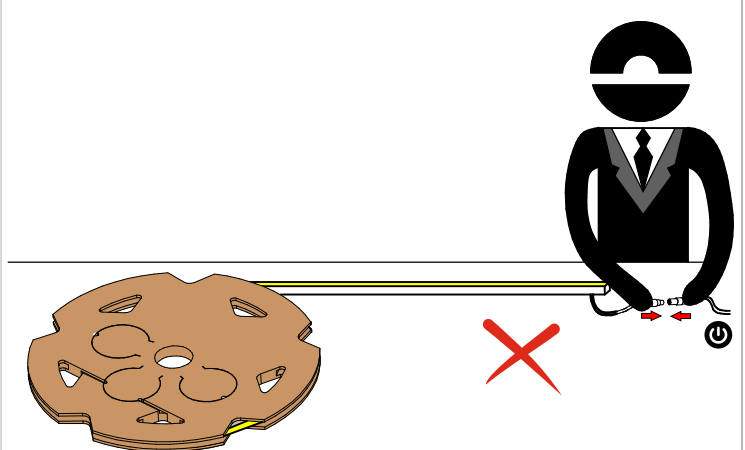
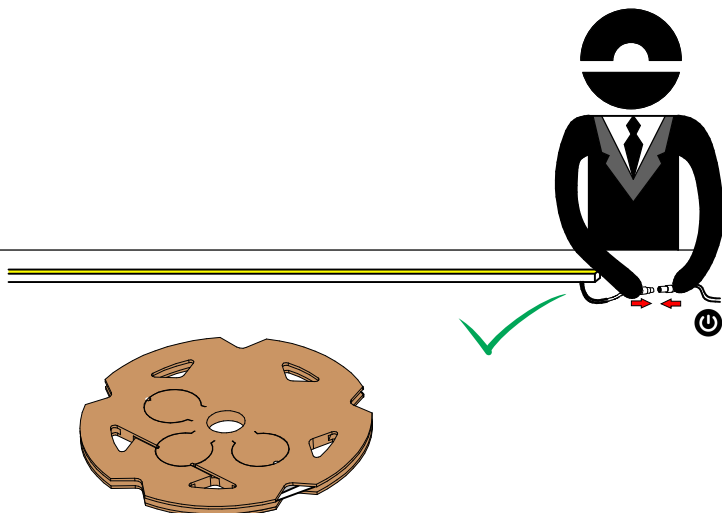

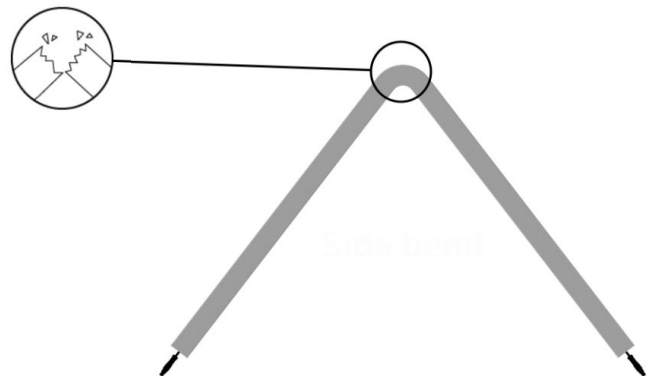
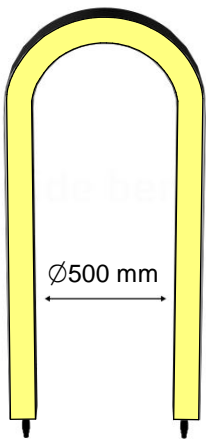
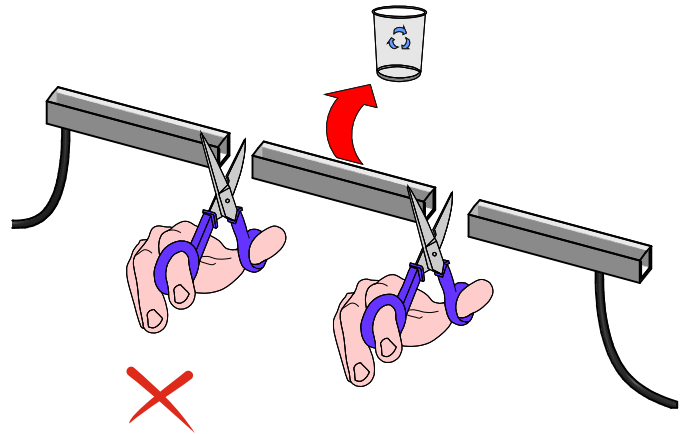
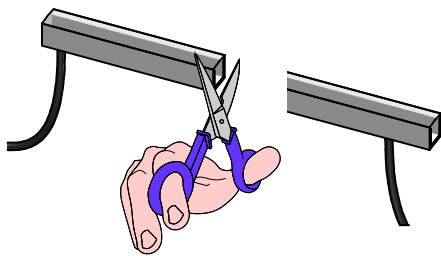
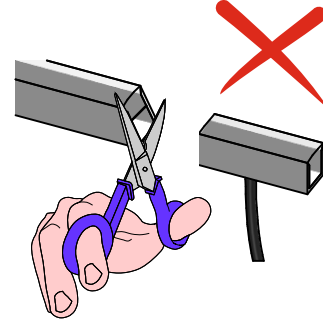
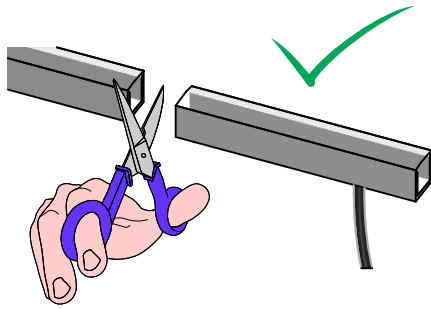

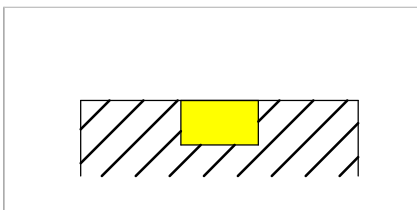
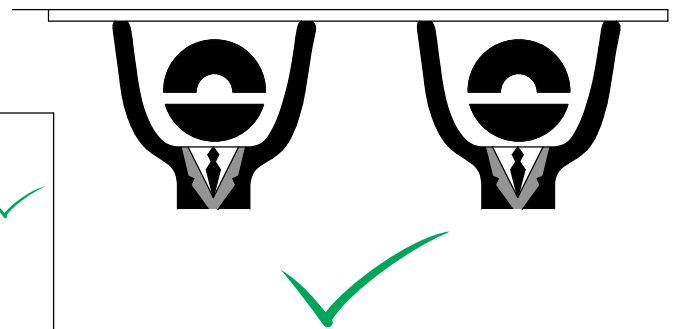
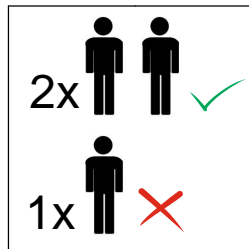
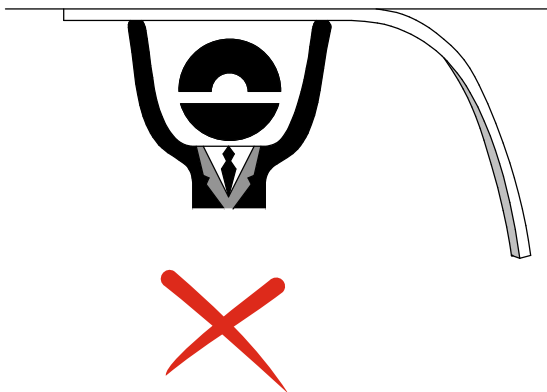
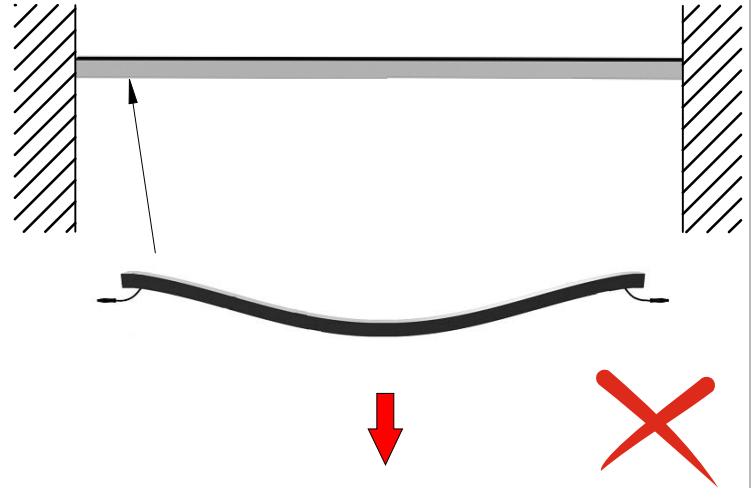
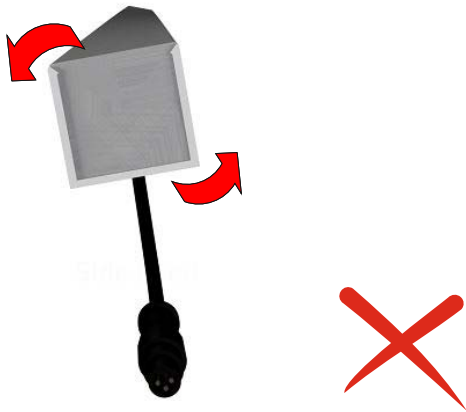
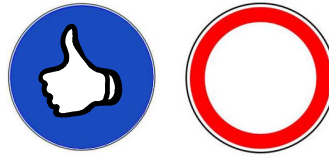

IT - Garantire il drenaggio dell'acqua per installazioni a pavimento

EN - Ensuring water drainage for floor installations

DE - Sicherstellung des Wasserabflusses für Bodeninstallationen

FR - Assurer l'évacuation de l'eau pour les installations au sol

ES - Garantizar el drenaje del agua en instalaciones de suelo

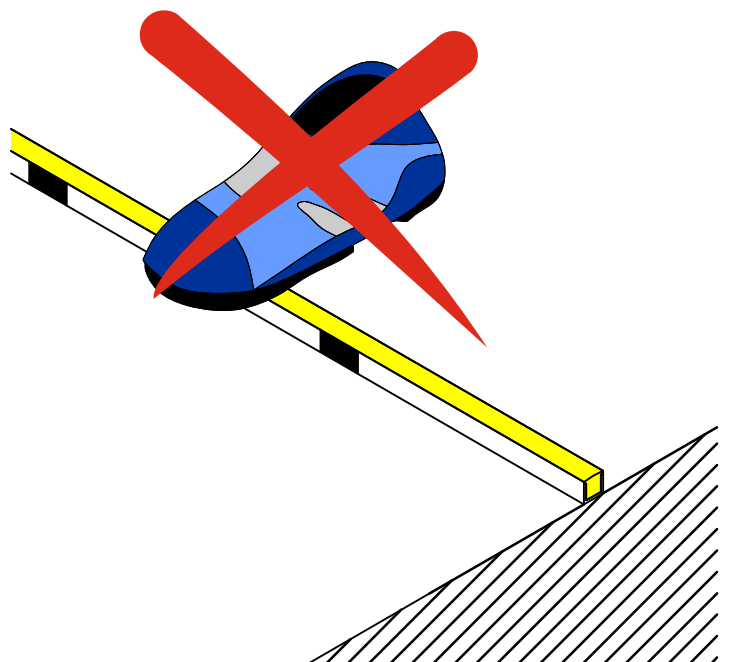

IT - Accessori da utilizzare e non, per il montaggio
 EN - Accessories to use and not to use for assembly
 DE - Für die Montage zu verwendendes und nicht zu verwendendes Zubehör
 FR - Accessoires à utiliser et à ne pas utiliser pour le montage
 ES - Accesorios a utilizar y no utilizar para el montaje

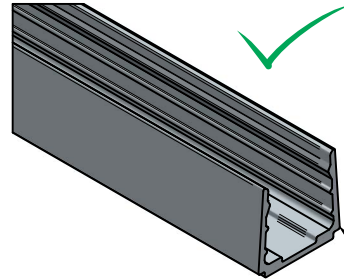
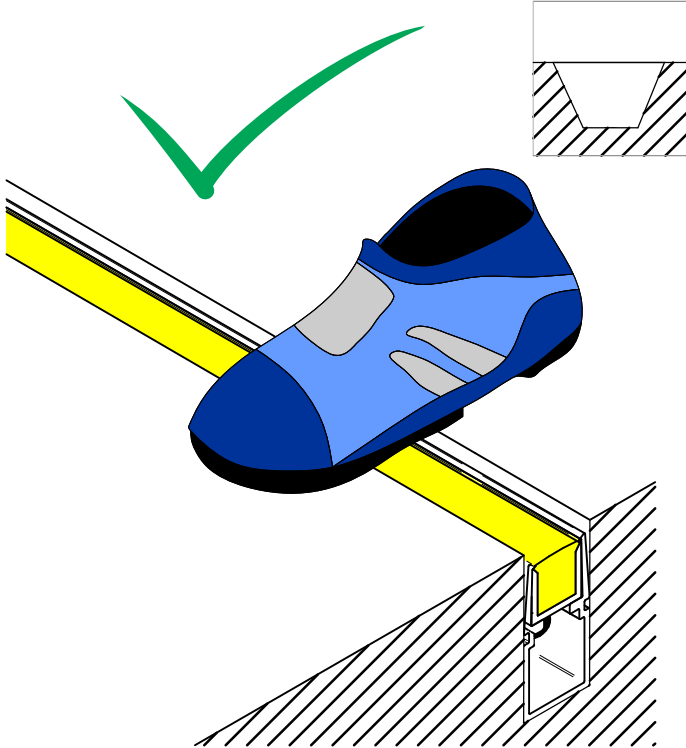

| Code | Color | Length |
|-----------|-------|--------|
| 99549 | Gray | 1m |
| 82198 | Gray | 2m |
| C-K100007 | Black | 1m |
| C-K100008 | Black | 2m |

See instruction sheet FGI00249

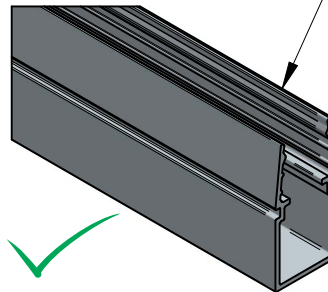

| Code | Color | Length |
|-----------|-------|--------|
| 83034 | Gray | 1m |
| 82199 | Gray | 2m |
| C-K100009 | Black | 1m |
| C-K100010 | Black | 2m |

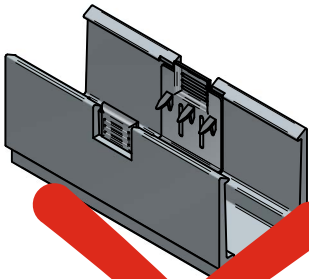

| Code | Color | Length |
|-----------|-------|--------|
| C-F400001 | Gray | 50 mm |
| C-F400002 | Black | 50 mm |

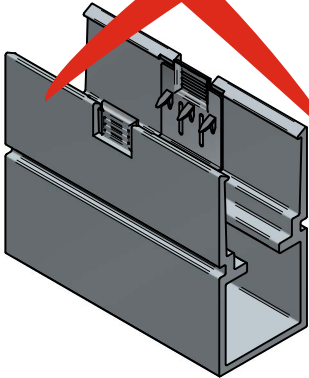

| Code | Color | Length |
|-----------|-------|--------|
| C-F400003 | Gray | 50 mm |
| C-F400004 | Black | 50 mm |

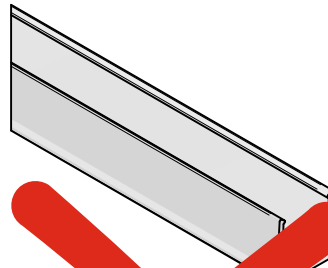

| Code | Color | Length |
|-----------|-------|--------|
| C-K100004 | White | 2m |
| C-K100005 | White | 1m |

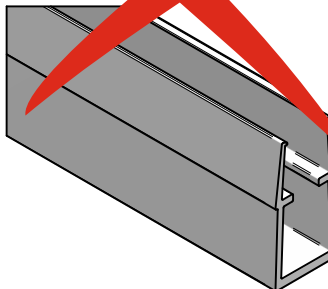

| Code | Color | Length |
|-----------|-------|--------|
| C-K100001 | White | 2m |
| C-K100002 | White | 1m |

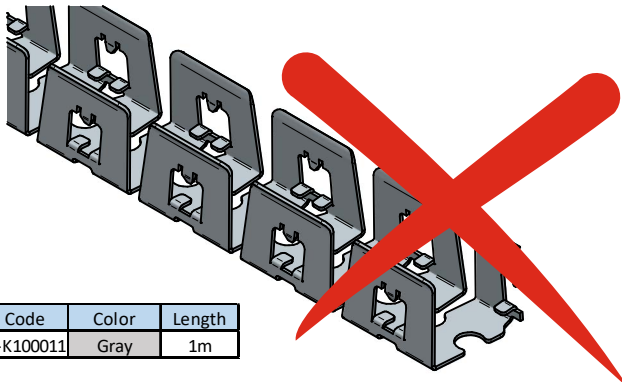

| Code | Color | Length |
|-----------|-------|--------|
| C-K100011 | Gray | 1m |

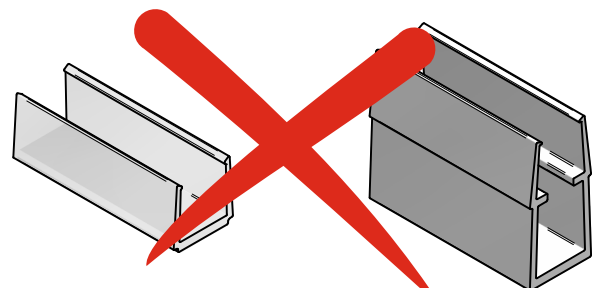

| Code | Color | Length |
|-----------|-------|--------|
| C-K100003 | White | 50 mm |

| Code | Color | Length |
|-----------|-------|--------|
| C-K100006 | White | 50 mm |

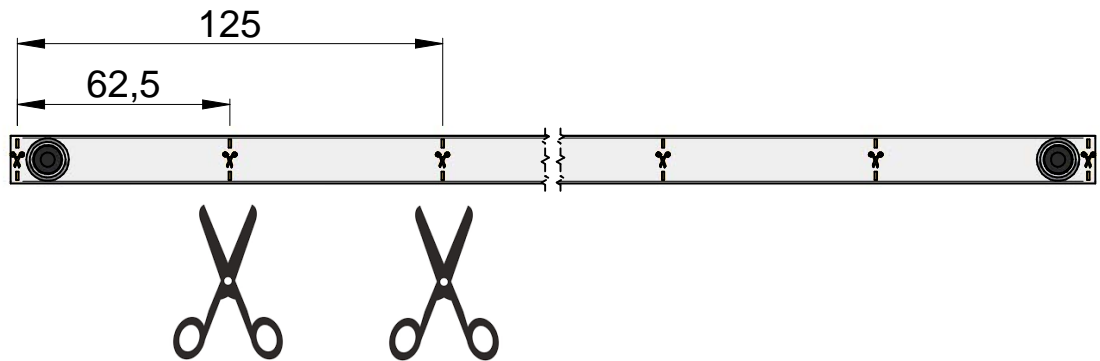

1

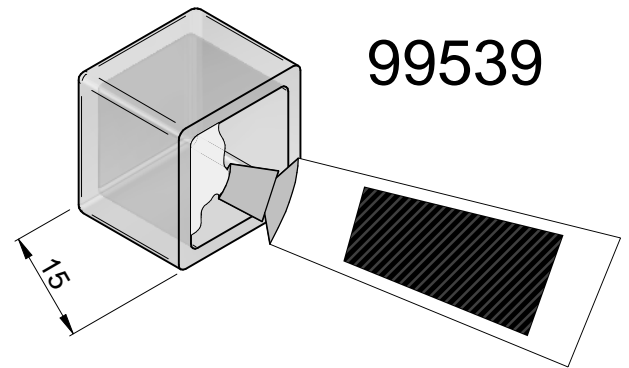
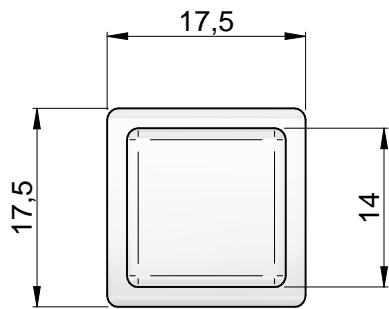

2

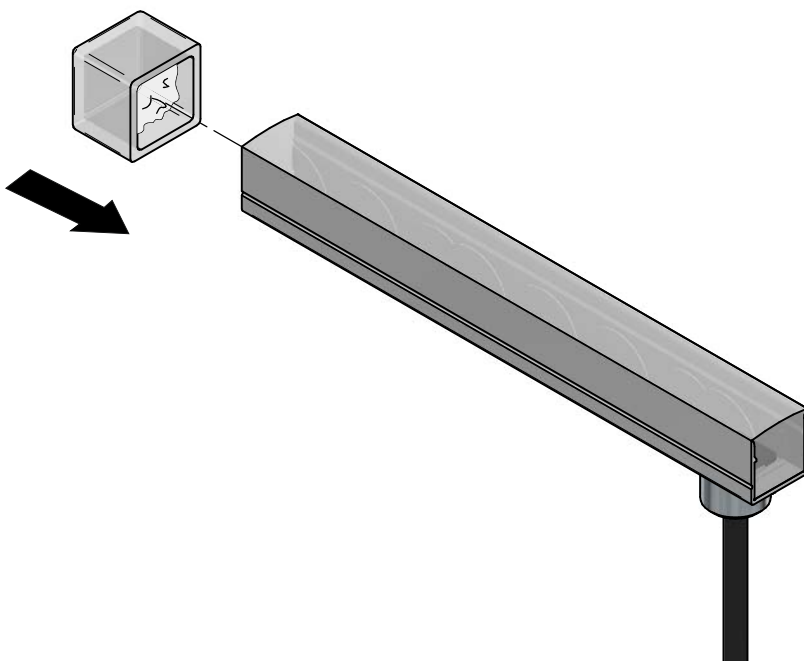

3

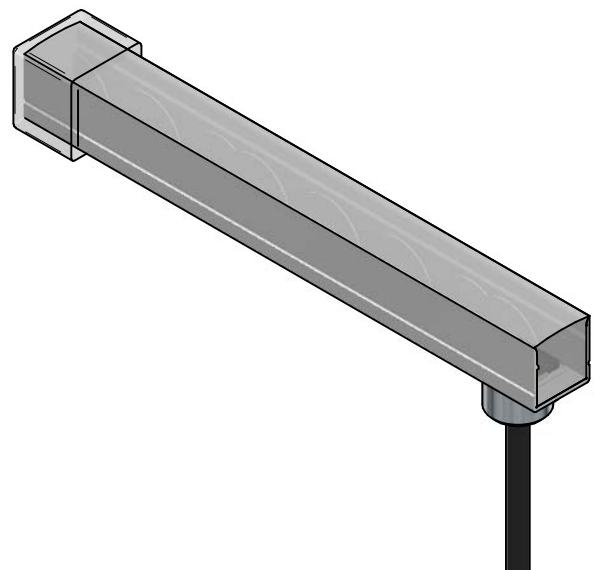

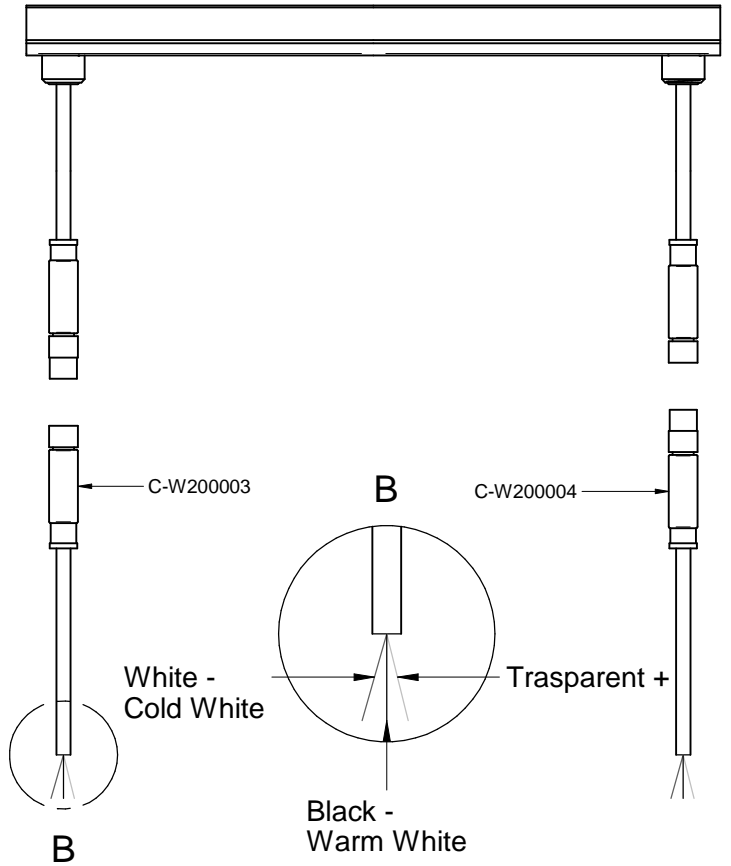
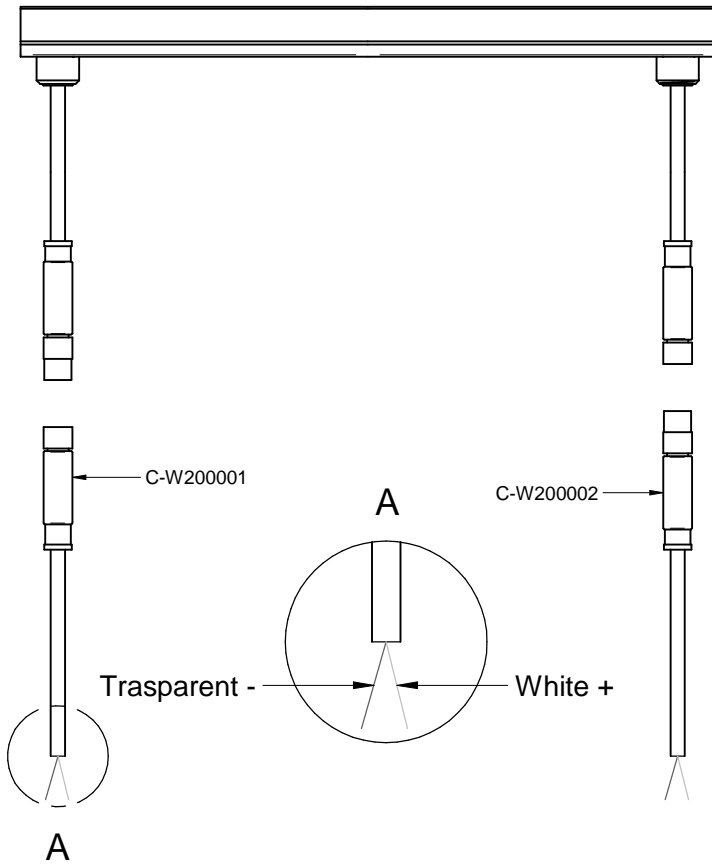

Cable not included

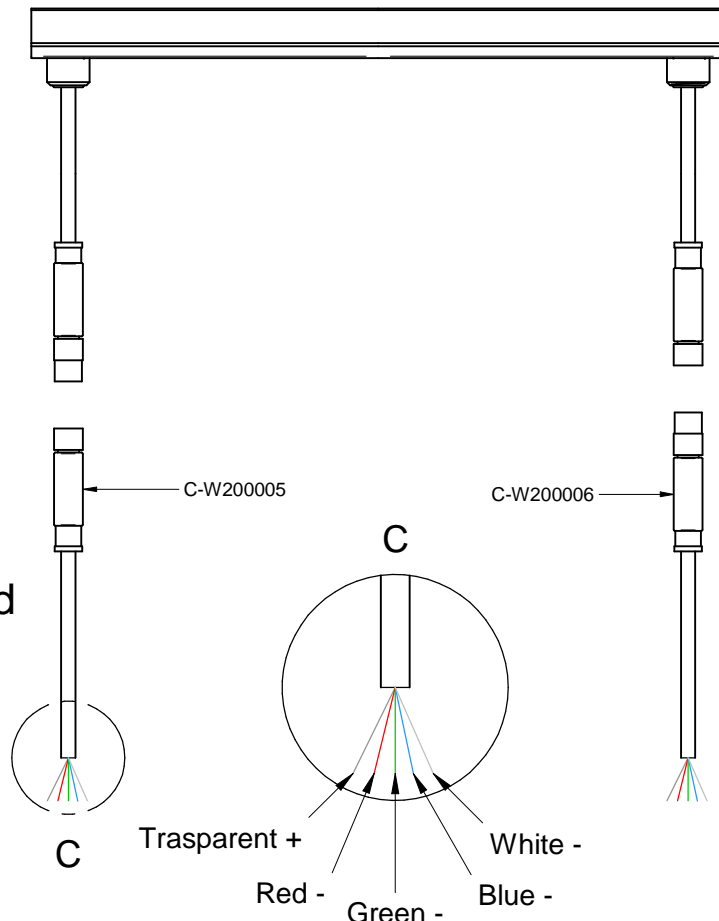

Single color

| Rubber 5W/M | | | |
|-------------|------|--------|--------|
| | Xmm | L1 max | L2 max |
| | 0,75 | 40m | 5m |
| | 0,75 | 25m | 10m |
| | 1,5 | 50m | 5m |
| | 1,5 | 50m | 10m |
| | 2,5 | 60m | 5m |
| | 2,5 | 50m | 10m |

| Rubber 10W/M | | | |
|--------------|------|--------|--------|
| | Xmm | L1 max | L2 max |
| | 0,75 | 30m | 5m |
| | 0,75 | 5m | 10m |
| | 1,5 | 40m | 5m |
| | 1,5 | 10m | 10m |
| | 2,5 | 40m | 5m |
| | 2,5 | 20m | 10m |

| Rubber 15W/M | | | |
|--------------|------|--------|--------|
| | Xmm | L1 max | L2 max |
| | 0,75 | 20m | 5m |
| | 1,5 | 30m | 5m |
| | 2,5 | 30m | 5m |
| | 2,5 | 5m | 10m |
| | 2,5 | 5m | 10m |

$$L2 = L3 + L4$$

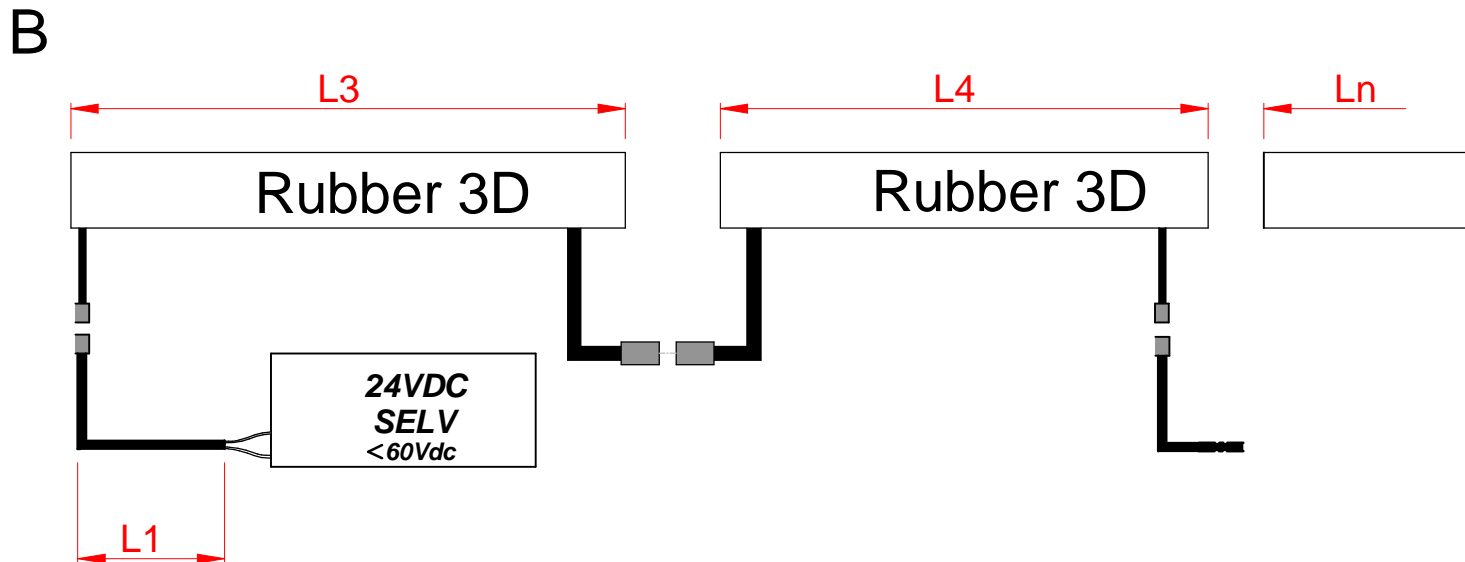
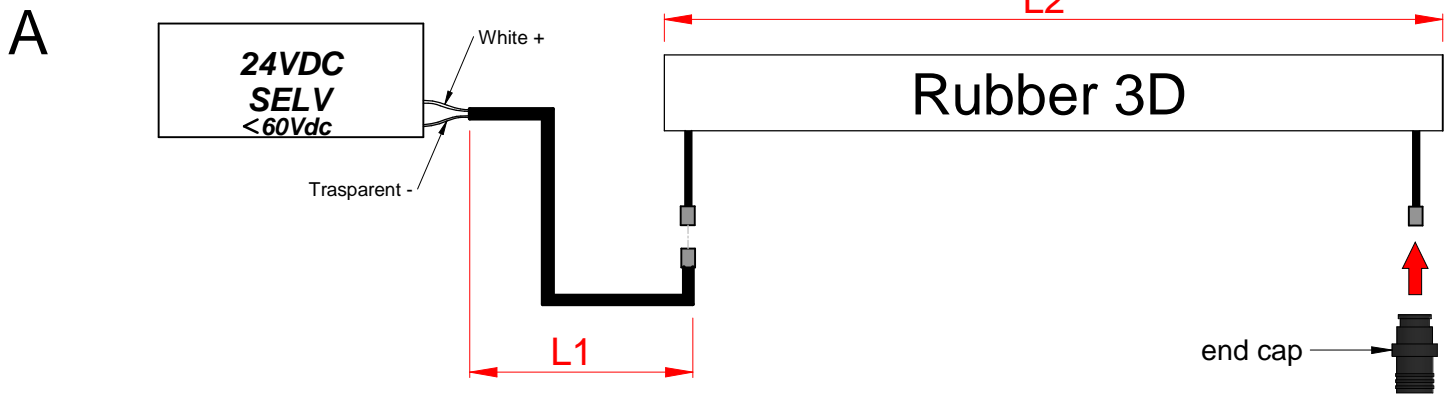

RGBW

| | Xmm | L1 max | L2 max |
|--|------|--------|--------|
| | 0,75 | 20m | 5m |
| | 1,5 | 30m | 5m |
| | 2,5 | 30m | 5m |

$$L2 = L3 + L4$$

A

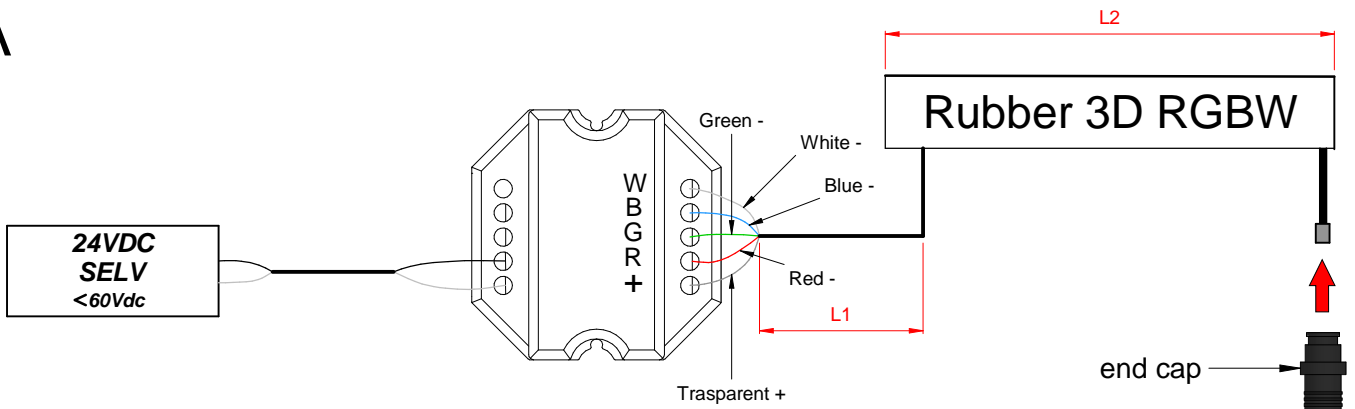

B

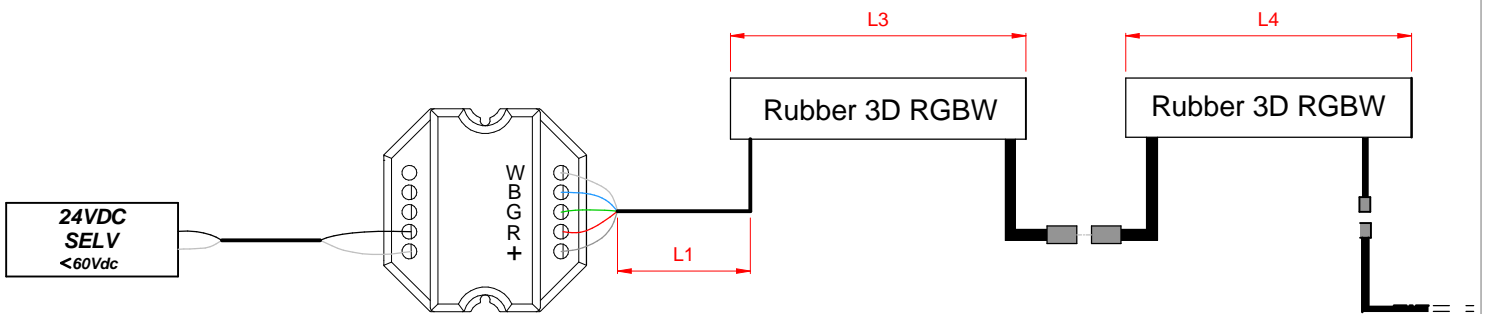

Dynamic

| | Xmm | L1 max | L2 max |
|--|------|--------|--------|
| | 0,75 | 10m | 5m |
| | 1,5 | 25m | 5m |
| | 2,5 | 30m | 5m |

$$L2 = L3 + L4$$

A

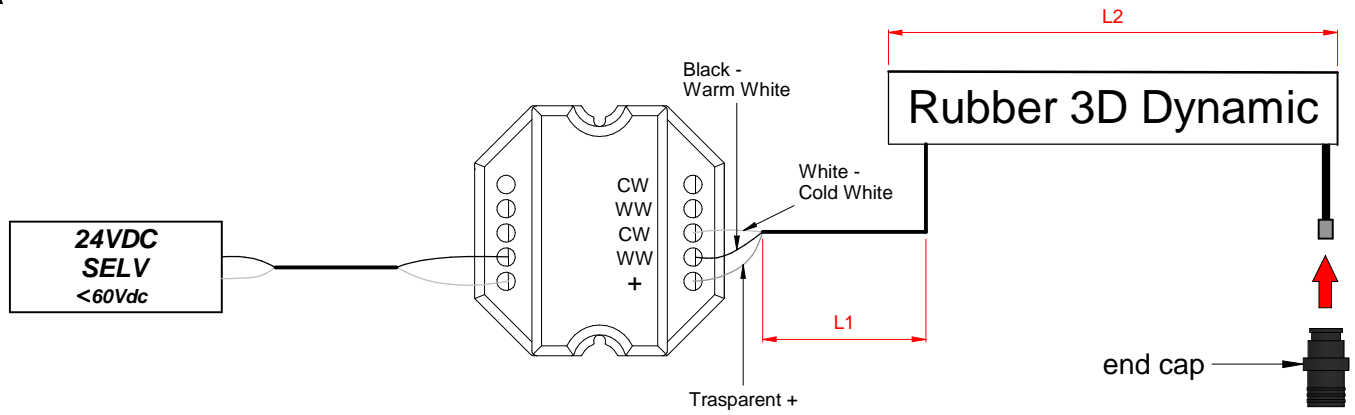

B

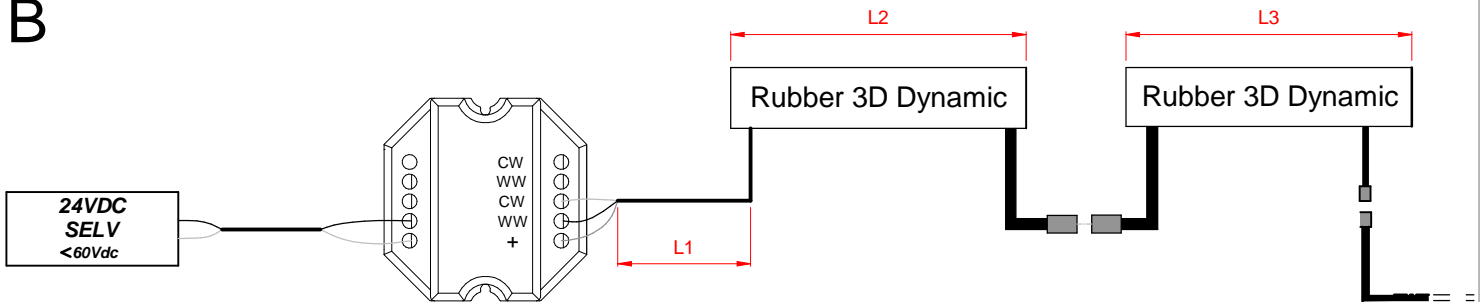

ISTRUZIONI PER IL LAVAGGIO DELL'APPARECCHIO D'ILLUMINAZIONE
LUMINAIRE CARE INSTRUCTIONS
ISTRUCCIONES PARA LIMPIAR LA LUMINARA
INSTRUCTIONS POUR LE LAVAGE DE L'APPAREIL D'ECLAIRAGE
ANLEITUNG ZUR REINIGUNG DES BELEUCHTUNGSGERATS

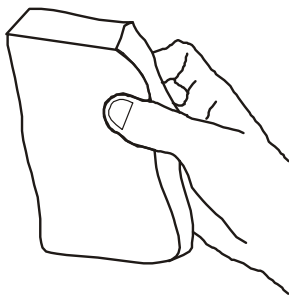
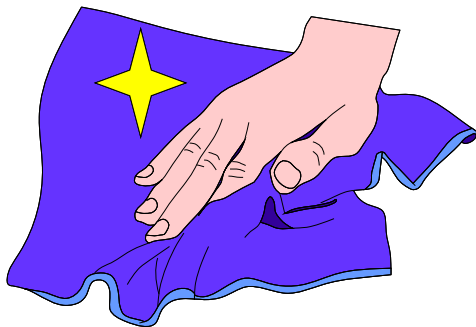

IT - ATTENZIONE!!!

Lavare la superficie del diffusore luce con panno umido, utilizzando solo acqua e sapone neutro.

EN - WARNING!!!

Wipe clean with a cloth dampened in water with neutral detergent.

ES - ATENCION!!!

Limpie la superficie del difusor con un pano humedecido con agua y jabon neutro.

FR - ATTENTION!!!

Laver la surface du diffuseur de lumiere a l'aide d'un chiffon humide et en utilisant seulement de l'eau et du savon neutre.

DE - ACHTUNG!!!

Die oberfläche vom lampenschirm mit einem feuchten lappen reinigen. De lappen mit wasser und neutralseife befeuchten.

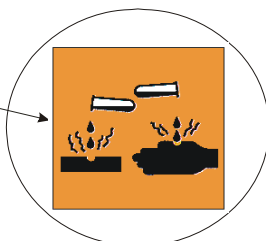
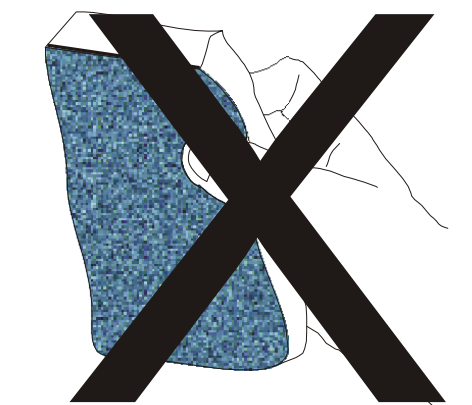

IT - ATTENZIONE!!!

Non utilizzare panni abrasivi e/o solventi.

EN - WARNING!!!

Avoiding the use of chemical solvents and/or abrasive cloths.

ES - ATENCION!!!

No utilizar panos abrasivos y solventes.

FR - ATTENTION!!!

Ne pas utiliser de chiffons abrasifs ou de dissolvants.

DE - ACHTUNG!!!

Abschleifende tuche und/oder losungsmittel nicht benutzen.