



Warnings

To guarantee the best performances and the full use of functions, make sure to download on your device the last release of CASAMBI APP.

- Functionality test are done on all dimmers to ensure the right working. In case the device is still paired to “Dalcnet network”, you are asked to unpair it by following the instructions on CASAMBI APP.
- Whenever CASAMBI APP requires an upgrade of the profile installed in the LED Dimmers, follow the instruction to do it. This allows you to stay always up to date and benefit of new functions released.

Check the available profiles on the product manual in our website:
<http://www.dalcnet.com>

CASAMBI



FEATURES

- DIMMER+DRIVER CASAMBI
- Input: DC 12-24 Vdc
- Command: APP CASAMBI
- Local Command: N°4 Push Buttons Normally Open (N.O.)
- Control: Dimmer White, Tunable White, Color RGB, RGBW or RGB+W
- Voltage or Current output for LED strip
- Typical efficiency >95%
- Extended temperature range
- 100% Functional Test



➤ PRODUCT DESCRIPTION

This DLX1224 at 4 channels with CASAMBI module allows to control all kind of leds: White, Tunable White, RGB and RGBW.

Through this Dalcnet device it is possible to adjust the luminous brightness, to create multiple color scenes and settle color games, thanks to all commands available on "CASAMBI APP". The device is also provide with 4 analog input (n°4 Push Buttons Normally Open) to control up to four different scenes.

With Casambi APP it is possible to control Led lights just from one view, by taking a photo of the lamps in a room, or by creating different scenarios.

Controlling all your lamps from one view. it is possible to control all your lighting fixtures with one view, individually or as a group. For example it is possible create a group of lights within home (eg. bedroom, kitchen, etc..) as in the workplace (eg. offices, showroom, etc..) and turn all off / on or dim with just one tap

Control your lights from a photo. It is possible to control only the lights you desire, just taking a photo of the room, and putting the icon of the lamp on the real position.

Create scenes for different lighting situations: Thanks to this function it is possible to create and store on the app many scenarios with different levels of brightness, different color temperature or RGB scenes.

Download the free Casambi APP on APP STORE and GOOGLE PLAY.

Necessary conditions for a correct function are:

- Devices with O.S. APPLE iOS 8.2 o later version
- Devices with O.S. ANDROID 4.4 o later version
- Normally Open Push Buttons (N.O.)
- Casambi App, download for free on App Store and Google Play



➔ For the whole and updated **Device Manual** refer to producer's website: <http://www.dalcnet.com>

➔ For the correct functioning of **CASAMBI APP** refer to the CASAMBI website: <https://support.casambi.com/support/home>

➤ PRODUCTS CODE

CONSTANT CURRENT VARIANTS (common anode)

CODE	Supply voltage	Output	Channels	Commands
DLX1224-4CC350-CASAMBI	12-24V DC	4x350mA	4	APP CASAMBI – 4 push buttons N.O.
DLX1224-4CC500-CASAMBI	12-24V DC	4x500mA	4	APP CASAMBI – 4 push buttons N.O.

The factory default profile of the product is DLX4-CBM-RGB+W variant RGB+W

In case you want to use profiles like DLX4-CBM-W (White), DLX4-CBM-TW (Tunable White), DLX4-CBM-RGB (RGB) or DLX4-CBM-RGBW variant RGBW, etc, it is necessary to log in Casambi APP and download the desired profile. Warning: unpair the Dimmer Led by any Network Casambi.

CONSTANT VOLTAGE VARIANTS (common anode)

CODE	Supply voltage	Output	Channels	Commands
DLX1224-4CV-CASAMBI	12-24V DC	4 x 5A (max 10A tot)	1	APP CASAMBI – 4 push button N.O.









The factory default profile of the product is DLX4-CBM-RGB+W variant RGB+W

In case you want to use profiles like DLX4-CBM-W (White), DLX4-CBM-TW (Tunable White), DLX4-CBM-RGB (RGB) or DLX4-CBM-RGBW variant RGBW, etc, it is necessary to log in Casambi APP and download the desired profile. Warning: unpair the Dimmer Led by any Network Casambi.

➤ PROTECTIONS

		CC	CV
OTP	Over temperature protection ¹	✓	✗
OVP	Over voltage protection ²	✓	✓
UVP	Under voltage protection ²	✓	✓
RVP	Reverse polarity protection ²	✓	✓
IFP	Input fuse protection ²	✓	✓
OCP	Open circuit protection	✓	✗
CLP	Current limit protection	✓	✗

➤ TYPE OF PROFILES

PROFILE	Supply Voltage	Output	Channels	Commands	
DLX4-CBM-W	12-24V DC	4 x CC/CV	4	APP CASAMBI – push buttons N.O.	
DLX4-CBM-Dim to Warm	12-24V DC	2 x CC/CV	2	APP CASAMBI – push buttons N.O.	
DLX4-CBM-TW	12-24V DC	2 x CC/CV	2	APP CASAMBI – push buttons N.O.	
DLX4-CBM-TW 2700-6000K	12-24V DC	2 x CC/CV	2	APP CASAMBI – push buttons N.O.	
DLX4-CBM-TW 3000-5000K	12-24V DC	2 x CC/CV	2	APP CASAMBI – push buttons N.O.	
DLX4-CBM-RGB	12-24V DC	3 x CC/CV	3	APP CASAMBI – push buttons N.O.	
DLX4-CBM-RGBW	12-24V DC	4 x CC/CV	4	APP CASAMBI – push buttons N.O.	
DLX4-CBM-RGB+W	12-24V DC	4 x CC/CV	3+1	APP CASAMBI – push buttons N.O.	

¹ Thermal Protection on the output channel in case of high temperature. The thermal intervention is detected by transistor or current regulation (depending of the booster variant).

² Only control logic protection

➤ REFERENCE STANDARDS

EN 61347-1	Lamp controlgear - Part 1: General and safety requirements
EN 55015	Limits and methods of measurement of radio disturbance characteristics of electrical lighting and similar equipment
EN 61547	Equipment for general lighting purposes - EMC immunity requirements
EN 50581	Technical documentation for the assessment of electrical and electronic products with respect to the restriction of hazardous substances

➤ TECHNICAL SPECIFICATIONS

		Variants						
		Constant current			Constant voltage			
Supply voltage		DC min: 10.8 Vdc .. max: 26.4 Vdc						
Output voltage		min: $V_{in}/4$ - max: $V_{in}-0,9V$			= V_{in}			
Input current		max 2A			max 10A			
Output current		Variant 350 mA		Variant 500 mA		max 5 A/ch	max 10 A total ³	
		350mA/ch	max 1,4 A total	500mA/ch	max 2 A total			
		1ch	max 4ch	1ch	max 4ch			
Nominal power ⁴		@12V	4,2W/ch	16,8 W	6W/ch	24 W	60W/ch	120 Wmax
		@24V	8,4W/ch	33,6 W	12W/ch	48 W	120W/ch	240 Wmax
Power loss in standby mode		<500mW			<500mW			
Type of Load		R-L-C			R			
Thermal shutdown ⁵		150°C			-			
D-PWM dimming frequency		600 Hz ⁶						
D-PWM resolution		833 Step ⁶						
Operating frequencies		2,400...2,483GHz ⁶						
Maximum output power		4dBm ⁶						
Storage temperature		min: -40 max: +60 °C						
Ambient temperature		min: -10 max: +40 °C						
Wiring		2.5mm ² solid – 1.5mm ² stranded – 30/12 AWG						
Wire preparation length		5,5 – 6,5 mm						
Protection grade		IP20						
Casing material		Plastic						
Packaging unit (pieces/unit)		Single Carton Box 1pz						
Mechanical dimension		88 x 54 x 25 mm						
Packaging dimension		106 x 59 x 36 mm						
Weight		80g						

³ For the voltage version the device provides max 10A ($I_{tot} = I_{L1} + I_{L2} + I_{L3} + I_{L4}$). Each channel provides max 5A.

⁴ Maximum value, depends on the ventilation conditions.

⁵ Thermal Protection on the output channel in case of high temperature. The thermal intervention is detected by current regulation (depending of the booster variant).

⁶ The values depend on the configuration of the Casambi module.

➤ INSTALLATION

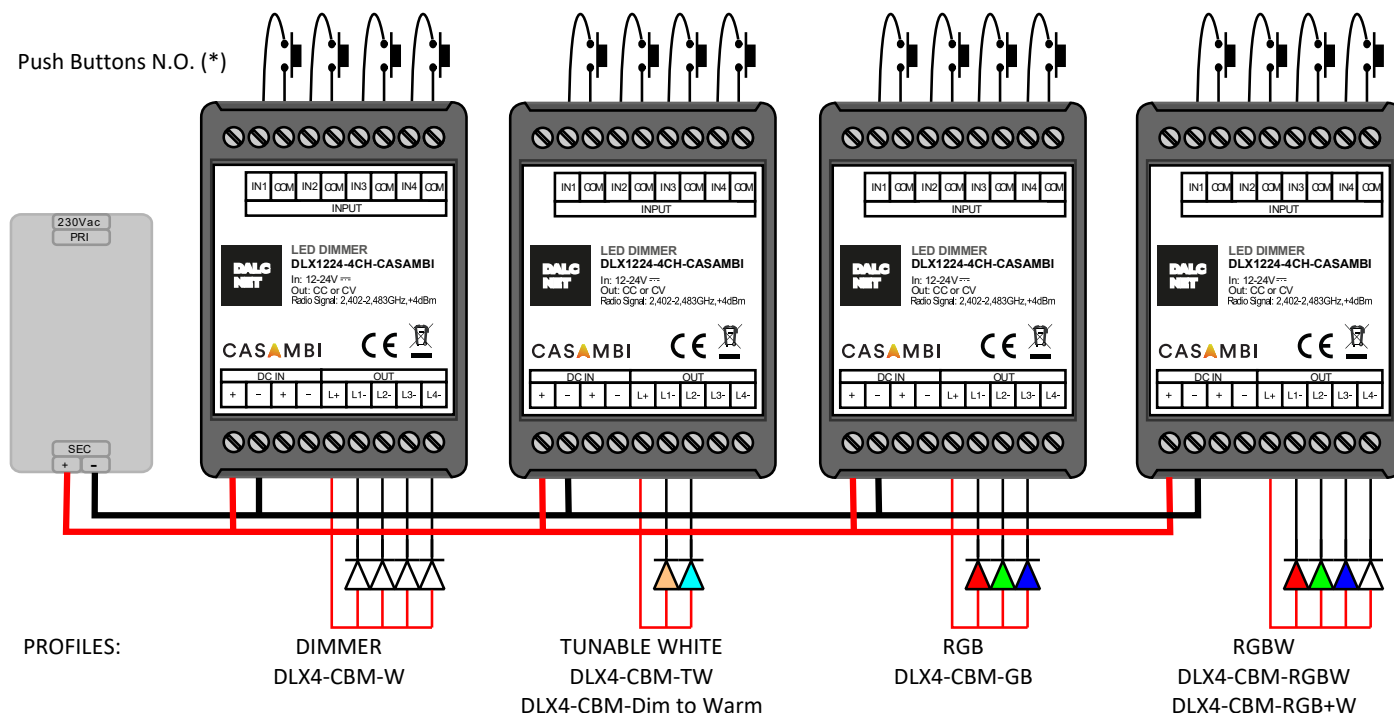

*For the control with the Push Buttons N.O. see the documentations in the website: <https://support.casambi.com/support/home>.

Note: For the length of the cables see the Technical Note

➤ TECHNICAL NOTE:

Installation:

- Installation and maintenance must be performed only by qualified personnel in compliance with current regulations.
- The product must be installed in a vertical or horizontal position with the cover / label upwards or vertically; Other positions are not permitted. It is not permitted to bottom-up position (with the cover / label down).
- Keep separated the circuits at 230V (LV) and the circuits not SELV from circuits to low voltage (SELV) and from any connection with this product. It is absolutely forbidden to connect, for any reason whatsoever, directly or indirectly, the 230V mains voltage to the bus or to other parts of the circuit.

Power supply:

- For the power supply use only a SELV power supplies with limited current, short circuit protection and the power must be dimensioned correctly. In case of using power supply with ground terminals, all points of the protective earth (PE = Protection Earth) must be connected to a valid and certified protection earth.
- The connection cables between the power source "low voltage" and the product must be dimensioned correctly and they should be isolated from every wiring or parts at voltage not SELV. It is recommended to use double insulated cables.
- Dimension the power supply for the load connected to the device. If the power supply is oversized compared with the maximum absorbed current, insert a protection against over-current between the power supply and the device.
- For the constant current output, the voltage of LED module (Vf) must be less of 5V at the voltage of power supply.

Command:

- The length of the connection cables between the local commands (N.O. Push button or other) and the product must be less than 10m; the cables must be dimensioned correctly and they should be isolated from every wiring or parts at voltage not SELV. It is recommended to use shielded and twisted cables.
- All the product and the control signal connect at the local command (N.O. Push button or other) must be SELV (the devices connected must be SELV or supply a SELV signal)

Outputs:

- The length of the connection cables between the product and the LED module must be less than 10m; the cables must be dimensioned correctly and they should be isolated from every wiring or parts at voltage not SELV. It is recommended to use shielded and twisted cables.

WARNING: For optional functionality of the Bluetooth signal, do not put the device into metal or aluminium boxes and do not shield the device.

As any other Bluetooth product, should not be placed in a metal enclosure or next to large metal structures. Metal will effectively block all radio signal which are crucial to the operation of the product.

➤ MECHANICAL DIMENSIONS:

