









DOCKS ALLUMINIO CON GRIGLIA - ANTIVANDALO

COD.	9064
LAMPADA	 E27
POTENZA	75W/L=180
TENSIONE	220-240V/50-60Hz
IP	IP 66 
IK	IK10 (20 joules)
CLASSE	Classe I
CERTIFICAZIONE	CE
CONFORMITÀ	EN 60598-1:2015 + EN 60598-2-1:1989
COLORI	 BI /  GM /  GR
CLASSE ENERGETICA	

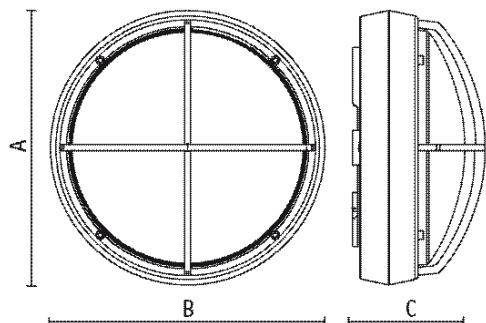

SPECIFICHE

- Struttura in alluminio primario
- Viti inox
- Diffusore in policarbonato antivandalo IK 10
- Guarnizione in silicone
- Ingresso cavi dal retro

DIMENSIONI

- A 268 mm
- B 268 mm
- C 129 mm