

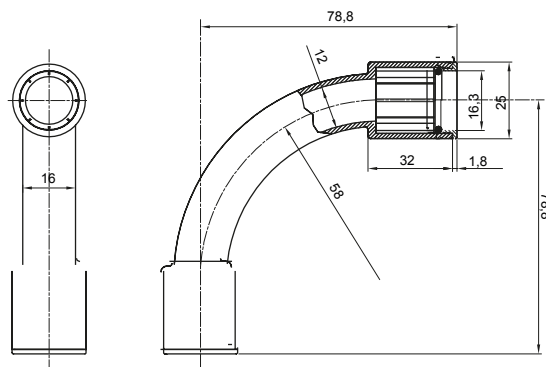

Componenti di percorso per i tubi protettivi rigidi serie RK con gradi di protezione IP40 e IP67.

| | | | |
|-------------------|-----------------|---------------------|-------------------------------------|
| Colore | Grigio RAL 7035 | Grado di protezione | IP67 |
| Tubi Ø (mm) | 16 | Tipo Materiale | Halogen free secondo norma EN 50642 |
| Codice Electrocod | 21221 | | |

DIMENSIONALE



SIMBOLOGIA TECNICA

IP

HF
HALOGEN FREE

IP67

MARCHI/APPROVAZIONI

