

## Binario 48V DC MICRO H: sospensione

Codice: 22960033-00

### INFORMAZIONI GENERALI



Articolo	Binario 48V DC MICRO H: sospensione
Codice	22960033-00

### DIMENSIONI E PESO

Lunghezza (mm)	1000 mm
Larghezza (mm)	19 mm
Altezza (mm)	24 mm
Peso (Kg)	0.5 kg



Lunghezza max. consentita in fila continua: 50m. Portata max. 100W. Sospensione ogni 900mm.



## **Binario 48V DC MICRO H: sospensione**

---

Codice: 22960033-00



## Binario 48V DC MICRO H: sospensione

Codice: 22960033-00

### MATERIALI E COLORI

Corpo In alluminio estruso con conduttori in rame.

Colore Nero

### NORME E CONFORMITÀ

Norme di riferimento EN60598-1. Hanno grado di protezione secondo la norma EN60529.

### GARANZIA

Garanzia post-vendita 3 yr

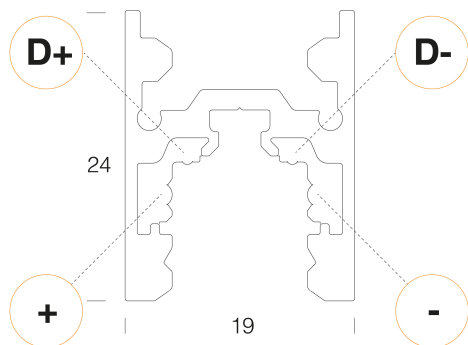

### DOWNLOAD

#### MONTAGGI

IstruzioniMontaggio MICRO H T R rev0.pdf

#### DISEGNI

DisegnoTecnico microh.dxf



## Binario 48V DC MICRO H: sospensione

Codice: 22960033-00

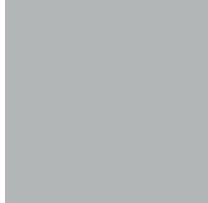

Staffa corta sospensione per Binario MICRO



Testata di chiusura per Binario MICRO H



Alimentazione a scomparsa per Binario MICRO

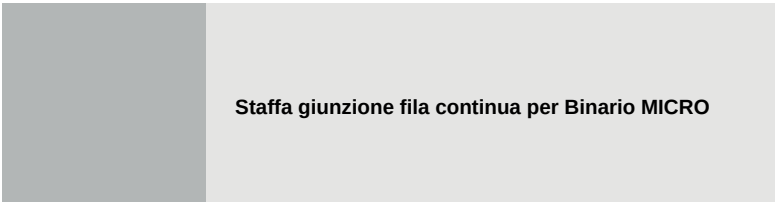

Staffa giunzione fila continua per Binario MICRO

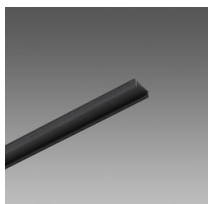

Copertura per Binario MICRO



Giunto lineare per Binario MICRO



Kit sospensione - Micro