

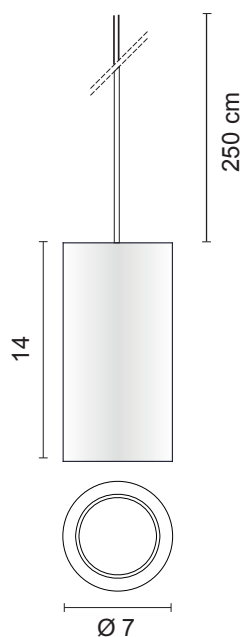





Rosoni e accessori per installazioni singole o multiple sono da ordinare separatamente

Ceiling rose and accessories for single or multiple installations must be ordered separately

Dimensioni - Dimensions



modello: model:	EGOTUBE
codice: code:	1660
design:	U. T. Egoluce
anno - year:	2020
tipologia: typology:	lampada da sospensione suspension lamp
materiali: materials:	struttura in alluminio aluminum structure
luce: light:	diretta direct
sorgente luminosa: light sources:	7W GU10 LED
grado IP - IP grade:	20
peso netto - net weight:	0,30 Kg
finiture: finishes:	.01 bianco .02 nero .35 sabbia .02.28 nero, interno foglia rame .02.29 nero, interno foglia oro .31.01 cromato, interno bianco
marcatura: marking:	CE
simboli costruttivi: symbols:	  



.01 Bianco - White



.02 Nero - Black



.35 Sabbia - Sand



.02.28 Nero foglia rame
Black copper leaf



.02.29 Nero foglia oro
Black gold leaf



.31.01 Cromato - Bianco
Chrome - White

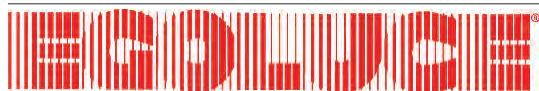

EGOLUCE s.r.l., via I.Newton 12 - 20016 Pero - Milano
telefono +39 02 339586.1 - fax. +39 02 3535112
e-mail: info@egoluce.com - http://www.egoluce.com

La presente scheda tecnica è di proprietà di EGOLUCE srl. Tutti i diritti sono riservati. Le fotografie, le descrizioni degli apparecchi, i disegni quotati ed i valori fotometrici menzionati sono a titolo indicativo e non costituiscono alcun impegno per la nostra società che si riserva di apportare, in qualsiasi momento e senza preavviso, tutte le modifiche che riterrà opportune.

Accessori - rosoni lampada singola - **Accessories** - single lamp ceiling rose**0604**Rosone senza interruttore 1 uscita laterale
1 Egotube - 50/60Hz 220-240VCeiling rose without switch 1 side hole
1 Egotube - 50/60Hz 220-240V

- .01** Bianco - *White*
- .02** Nero - *Black*

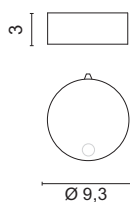

0,15 Kg

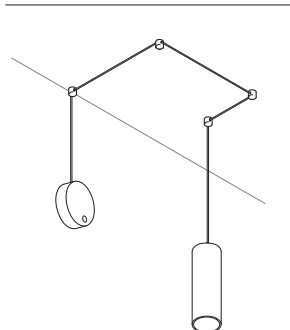
N° 1 art. 1660 - 1661 + 0604
+ N° 4 art. 0605**0947**Piastra con molle per controsoffitti
Ceiling plate with springs

- .01** Bianco - *White*
- .02** Nero - *Black*
- .35** Sabbia - *Sand*

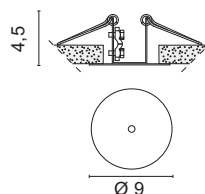

7,5 cm

0,08 Kg

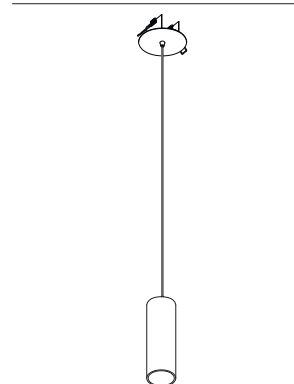

N° 1 art. 1660 - 1661 + 0947

**0607**Rosone in policarbonato per sospensione
1 Egotube - 50/60Hz 220-240VPolycarbonate ceiling rose for suspension
1 Egotube - 50/60Hz 220-240V

- .01** Bianco - *White*
- .02** Nero - *Black*
- .35** Sabbia - *Sand*

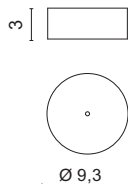

0,20 Kg

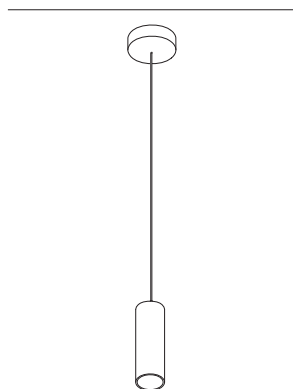

N° 1 art. 1660 - 1661 + 0607



N° 1 art. 1660 - 1661 + 0607

**0605**Deviatore e decentratore - Ø 1,7 H 2,2
Displacement element - Ø 1,7 H 2,2

- .01** Bianco - *White*
- .02** Nero - *Black*

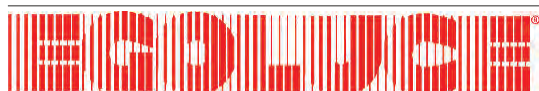
EGOLUCE s.r.l., via I. Newton 12 - 20016 Pero - Milano
telefono +39 02 339586.1 - fax. +39 02 3535112
e-mail: info@egoluce.com - http://www.egoluce.com

Accessori - rosoni tondi multipli - Accessories - rounded ceiling rose**0600**

Rosone per sospensione
3 Egotube - 50/60Hz 220-240V

Ceiling rose for suspension
3 Egotube - 50/60Hz 220-240V

.01 Bianco - *White*

.02 Nero - *Black*

.35 Sabbia - *Sand*

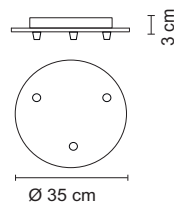

F 0,50 Kg

0601

Rosone per sospensione
5 Egotube - 50/60Hz 220-240V

Ceiling rose for suspension
5 Egotube - 50/60Hz 220-240V

.01 Bianco - *White*

.02 Nero - *Black*

.35 Sabbia - *Sand*

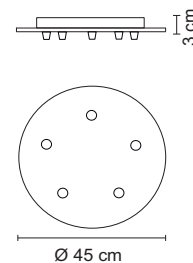

F 1,70 Kg

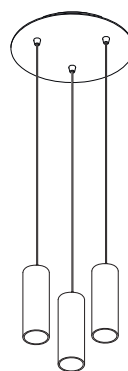

N° 3 art. 1560 - 1561 + 0600

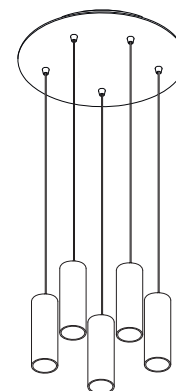

N° 5 art. 1560 - 1561 + 0601

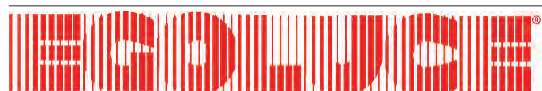

EGOLUCE s.r.l., via I. Newton 12 - 20016 Pero - Milano
 telefono +39 02 339586.1 - fax. +39 02 3535112
 e-mail: info@egoluce.com - <http://www.egoluce.com>

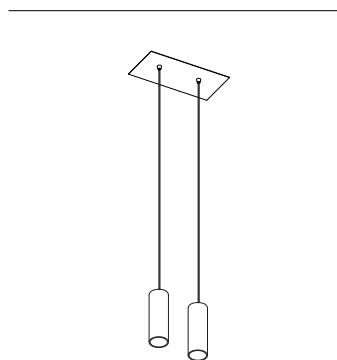
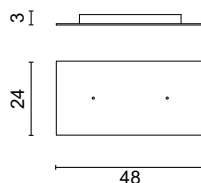
Accessori - rosoni quadrati multipli - **Accessories** - square ceiling rose**0978/2** 2,00 KgRosone per sospensione
2 Egotube 50/60Hz 220-240VCeiling rose for suspension
2 Egotube 50/60Hz 220-240V**.01** Bianco - White**.02** Nero - Black

N° 2 art. 1660 - 1661 + 0978/2

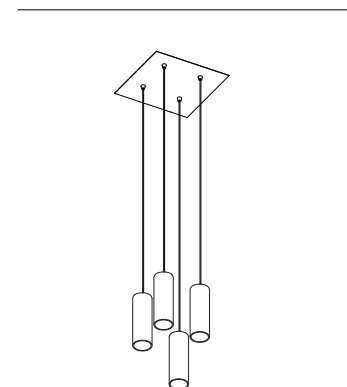
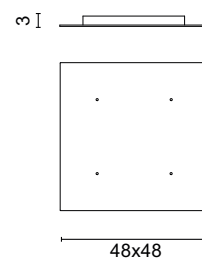
0978/4 3,80 KgRosone per sospensione
4 Egotube 50/60Hz 220-240VCeiling rose for suspension
4 Egotube 50/60Hz 220-240V**.01** Bianco - White**.02** Nero - Black

N° 4 art. 1660 - 1661 + 0978/4

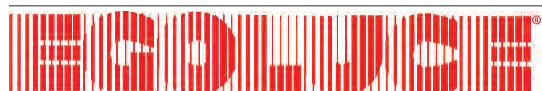
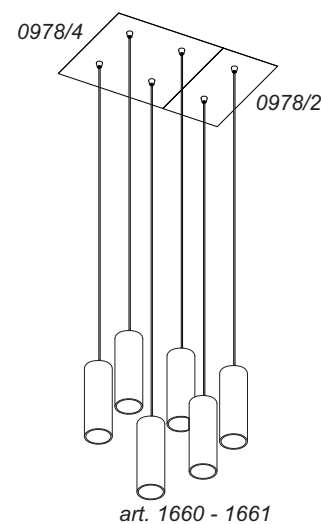
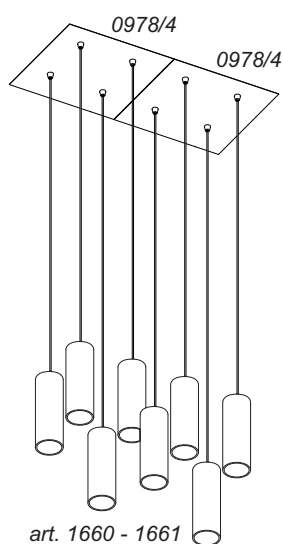
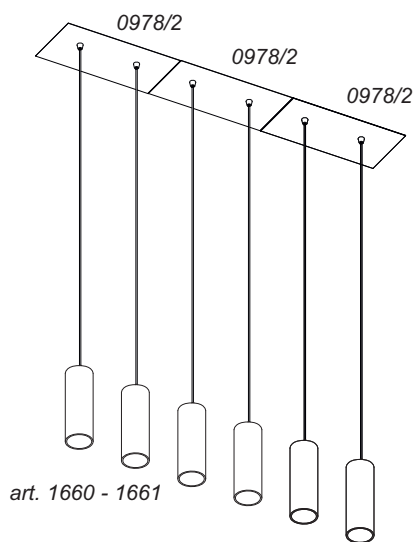
Esempio di installazione multipla - **Example of multiple installation**EGOLUCE s.r.l., via I. Newton 12 - 20016 Pero - Milano
telefono +39 02 339586.1 - fax. +39 02 3535112
e-mail: info@egoluce.com - http://www.egoluce.com

Accessori - rosoni tondi multipli con uscita cavi radiali - **Accessories** - rounded ceiling rose with radial cable exit



0603
Rosone per sospensione
1 - 4 Egotube - 50/60Hz 220-240V

Ceiling rose for suspension
1 - 4 Egotube - 50/60Hz 220-240V

- .01 Bianco - White
- .02 Nero - Black

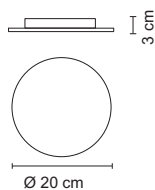

F 0,50 Kg



0602
Rosone per sospensione
1 - 12 Egotube - 50/60Hz 220-240V

Ceiling rose for suspension
1 - 12 Egotube - 50/60Hz 220-240V

- .01 Bianco - White
- .02 Nero - Black

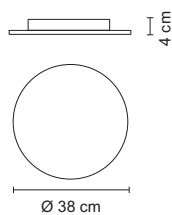

F 1,70 Kg



N° 3 art. 1660.01 + 0602.01

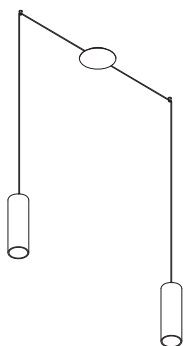

N° 2 art. 1660 - 1661 + 0603

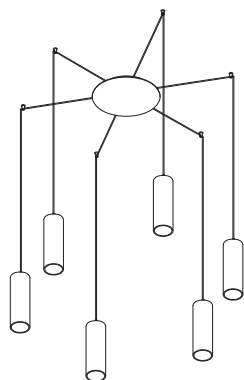

N° 6 art. 1660 - 1661 + 0602

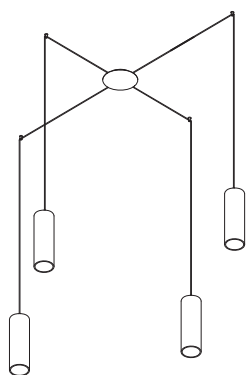

N° 4 art. 1660 - 1561 + 0603

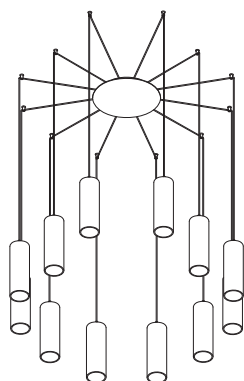

N° 12 art. 1660 - 1561 + 0602



0605
Deviatore e decentratore - Ø 1,7 H 2,2
Displacement element - Ø 1,7 H 2,2

- .01 Bianco - White
- .02 Nero - Black

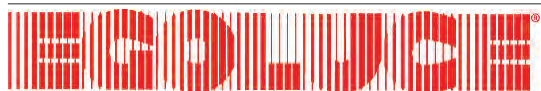

EGOLUCE s.r.l., via I.Newton 12 - 20016 Pero - Milano
telefono +39 02 339586.1 - fax. +39 02 3535112
e-mail: info@egoluce.com - http://www.egoluce.com

Accessori - rosoni lineari - **Accessories - linear ceiling rose****0613/3**

.01 Bianco - White
 .02 Nero - Black
 .35 Sabbia - Sand

Rosone lineare - **3 Egotube**
 Linear ceiling rose - **3 Egotube**
 50/60Hz 220-240V



1,10 Kg

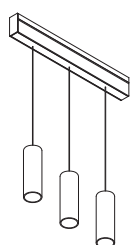
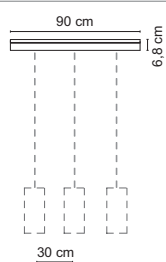

N° 3 art. 1660-1661 + 0613/3 ...

0613/4

.01 Bianco - White
 .02 Nero - Black
 .35 Sabbia - Sand

Rosone lineare - **4 Egotube**
 Linear ceiling rose - **4 Egotube**
 50/60Hz 220-240V



1,30 Kg

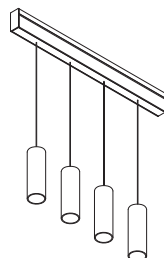
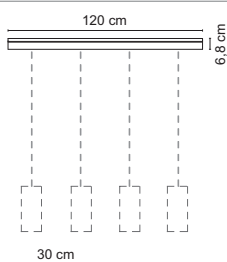

N° 4 art. 1660-1661 + 0613/4 ...

0613/6

.01 Bianco - White
 .02 Nero - Black
 .35 Sabbia - Sand

Rosone lineare - **6 Egotube**
 Linear ceiling rose - **6 Egotube**
 50/60Hz 220-240V



1,50 Kg

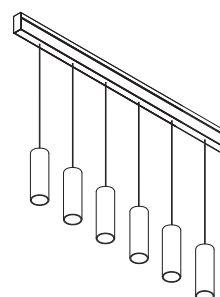
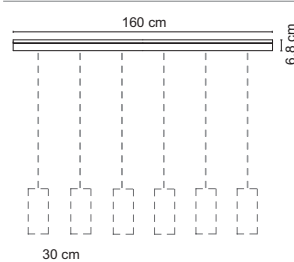

N° 6 art. 1660-1661 + 0613/6 ...

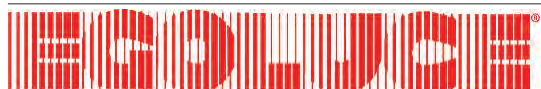

EGOLUCE s.r.l., via I. Newton 12 - 20016 Pero - Milano
 telefono +39 02 339586.1 - fax. +39 02 3535112
 e-mail: info@egoluce.com - http://www.egoluce.com