

NexiTech LED IP40

Self-contained luminaire / Einzelbatterieleuchte

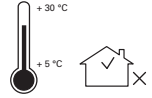

1

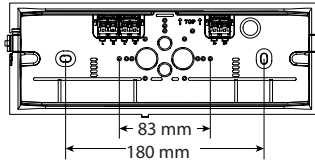
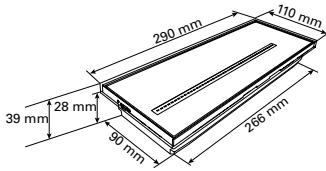
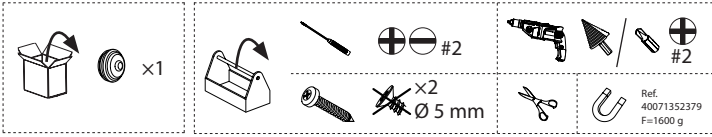
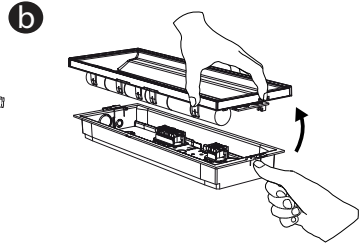
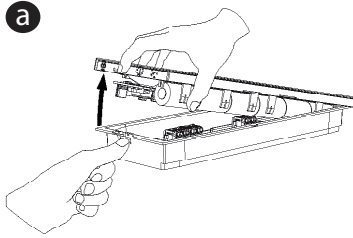

2

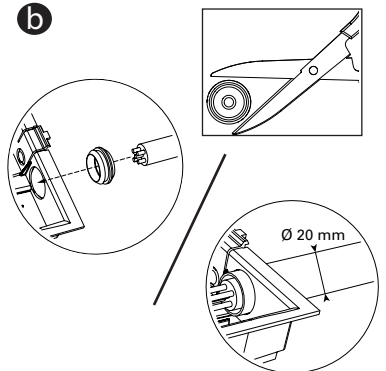
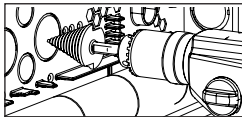
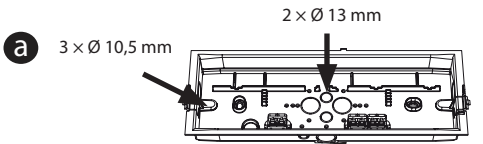

Powering Business Worldwide

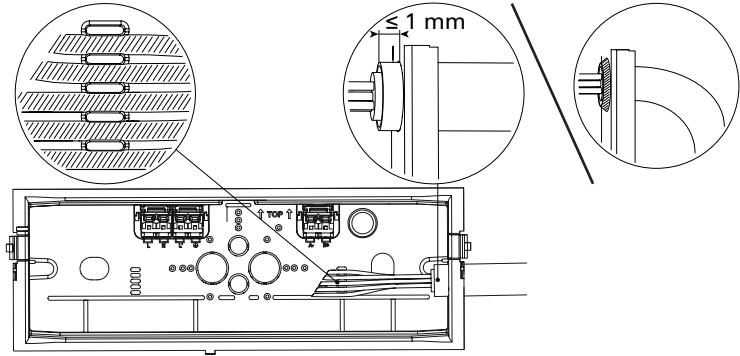

3

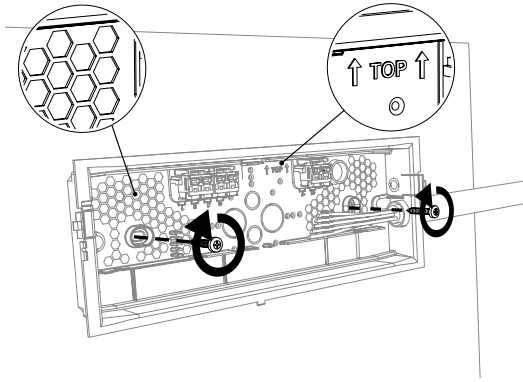
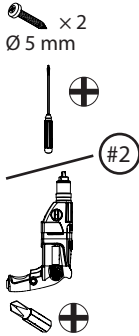

4

Rigid or flexible wire /
Flexible oder Starre Leitung
 $0,5 < S < 2,5\text{ mm}^2$

If rigid wire / Wenn starre
Leitung
 $1,5 < S < 2,5\text{ mm}^2$

In

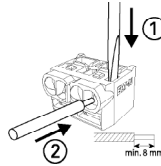

Out

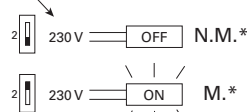
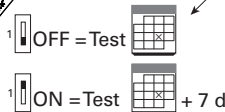
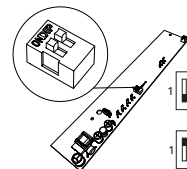
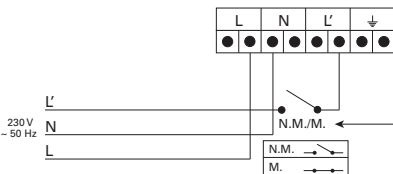
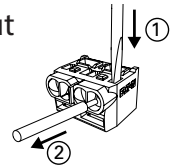

Not applicable for some
installations. /
Nicht zutreffend für einige
Installationen

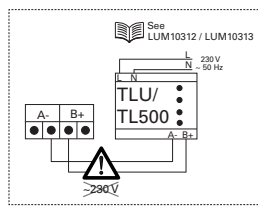

5 Option / Optional

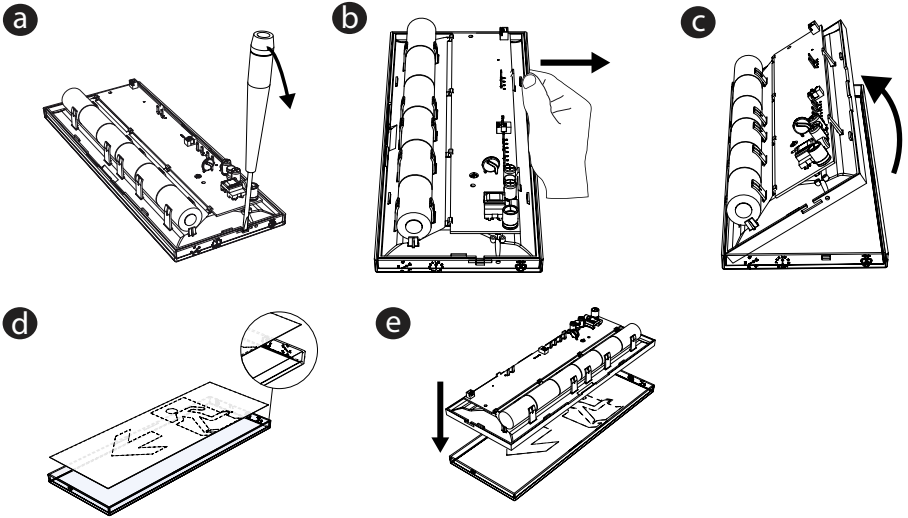
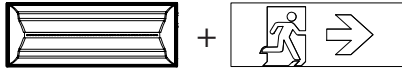

6

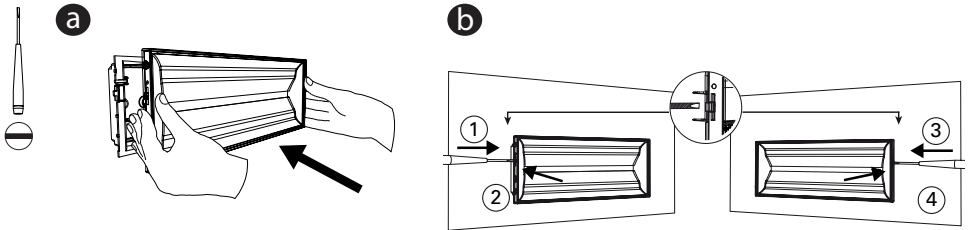

7

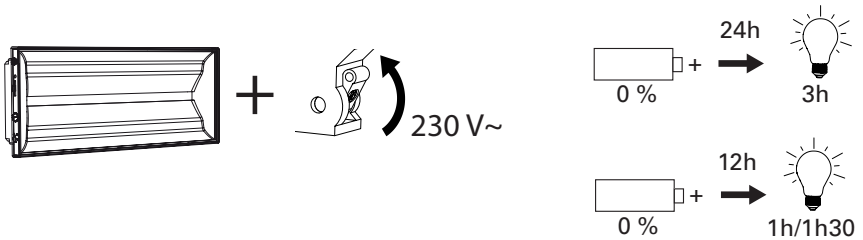

8 Test

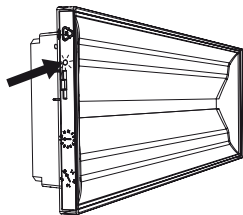

Green / Grün		OK
Green / Grün		Test
Yellow / Gelb		2 s
Yellow / Gelb		0,5 s

a

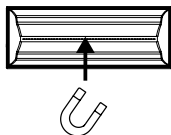

b

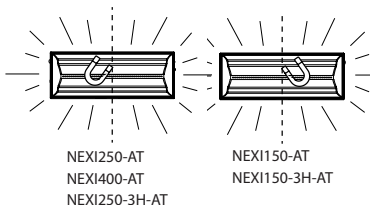

c

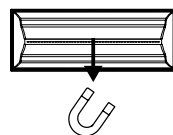

N.M. M.

N.M. = Non Maintained / Bereitschaftslicht
M. = Maintained / Dauerlicht

Model	IP40/IK03	Battery	Runtime	Light Output	Power
NEXI100-AT		3,6 V 0,8 Ah Ni-Cd	90 min	100 lm	0,65 W
NEXI150-AT		3,6 V 0,8 Ah Ni-Cd	60 min	150 lm	0,65 W 2,4 W
NEXI250-AT		7,2 V 1,7 Ah Ni-Cd	90 min	250 lm	2,25 W 3,6 W
NEXI400-AT		7,2 V 1,7 Ah Ni-Cd	90 min	400 lm	2 W 3,2 W
NEXI100-3H-AT		3,6 V 2 Ah Ni-Cd	180 min	100 lm	1,3 W
NEXI150-3H-AT		3,6 V 2 Ah Ni-Cd	180 min	150 lm	1,3 W 3,1 W
NEXI250-3H-AT		7,2 V 1,7 Ah Ni-Cd	180 min	250 lm	2,25 W 3,6 W



Not replaceable/
Nicht auswechselbar



+



NEXI-IP



NEXI-RB



NEXI-FC

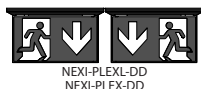

NEXI-PLEX-DD
NEXI-PLEX-DD



NEXI-PLEX-LR
NEXI-PLEX-LR



NEXI-PLEX-DB
NEXI-PLEX-DB



NEXI-PICTO-D



NEXI-PICTO-L



NEXI-PICTO-R



NEXI-PICTO-U

Eaton
EMEA Headquarters
Route de la Longeraie 7
1110 Morges, Switzerland
Eaton.eu

CEAG Notlichtsysteme GmbH
Senator-Schwartz-Ring 26
59494 Soest, Germany
Phone: +49 (0) 2921 69-870
Fax: +49 (0) 2921 69-617
E-mail: info-n@ceag.de
www.ceag.de
www.eaton.com

© 2018 Eaton
All Rights Reserved

Cooper CSA Srl
Via San Bovio, 3
20090 Segrate (Mi) - ITALY
Technical Service
www.coopercsa.it/it/nexitechled
Tel. +39 02 959501
www.coopercsa.it
www.eaton.it

ZNO2030400 D - 06/2018

Eaton is a registered trademark.

All trademarks are property of their respective owners.



WEEE : contact your local dealer

EATON

Powering Business Worldwide

