

## 368 - Raccordo testa-palo

Codice: 427002-00

### INFORMAZIONI GENERALI

Articolo	368 - Raccordo testa-palo
Codice	427002-00

### DIMENSIONI E PESO

Altezza (mm)	163 mm
Diametro (Ø) (mm)	60 mm
Peso (Kg)	1.6 kg

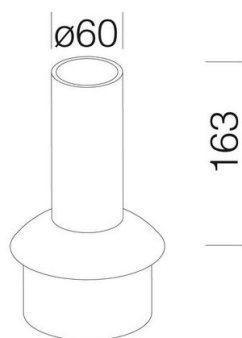

368 Raccordo testa-palo



## 368 - Raccordo testa-palo

---

Codice: 427002-00



## 368 - Raccordo testa-palo

Codice: 427002-00

### MATERIALI E COLORI

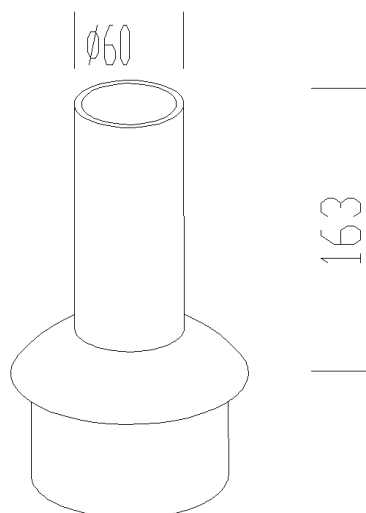

Corpo	in acciaio zincato.
-------	---------------------

Attacco palo	/
--------------	---

Colore	Grey9007
--------	----------

### GARANZIA

Garanzia post-vendita	0 yr
-----------------------	------

### DOWNLOAD

DISEGNI

DisegnoTecnico 368.dxf

