

Industrial blade-type cartridge fuses gG type

Catalogue number(s):
 0 163 04/12/18/20/22/25/30/35/40/45/50/55, 0 168 04/35/40/45/50/55/60,
 0 169 35/40/45/50/55, 0 173 04/50/55/60/65, 0 174 50/55/60/65, 0 175 60/65/70/75,
 0 178 04, 0 179 60/65/70/75, 0 181 04/75/80, 0 185 04/80/85/90/95

CONTENTS	PAGE
1. Description and usage.....	1
2. Range and characteristics.....	1
3. Compliance	3
4. Accessories.....	3
5. Curves.....	4

1. DESCRIPTION AND USAGE

Protection of conductors of electrical circuits in the event of overload or short circuit.

The discrimination ratio is 1.6 instead of 2.
 The 120,000 A breaking capacity enables complete protection in the most critical situations.
 Can be used to protect DC circuits supplied with a voltage of 48 V maximum.

Ceramic housing.

2. RANGE AND CHARACTERISTICS

2.1 Rated currents:

Current (Amps)	Size 00		Size 0		Size 1	
	With indicator	With striker	With indicator	With striker	With indicator	With striker
16	0 163 12					
25	0 163 18					
32	0 163 20					
35	0 163 22					
40	0 163 25					
50	0 163 30					
63	0 163 35		0 168 35	0 169 35		
80	0 163 40		0 168 40	0 169 40		
100	0 163 45		0 168 45	0 169 45		
125	0 163 50		0 168 50	0 169 50	0 173 50	0 174 50
160	0 163 55		0 168 55	0 169 55	0 173 55	0 174 55
200			0 168 60 (1)		0 173 60	0 174 60
250					0 173 65	0 174 65

Current (Amps)	Size 2		Size 3		Size 4	
	With indicator	With striker	With indicator	With striker	With indicator	With striker
200	0 178 60	0 179 60				
250	0 178 65	0 179 65				
315	0 178 70	0 179 70				
400	0 178 75	0 179 75				
500				0 181 75		
630				0 181 80		0 185 80
800						0 185 85
1000						0 185 90
1250						0 185 95 (1)

(1) non-standardised over-calibration

2.2 Rated voltage :

Up to 500 VAC and 48 VDC

2.3 Thermal dissipation of the cartridge fuses

Dissipation in watts of heat at rated current

Cat. No.	Consumption in W
0 163 12	1.8
0 163 18	2.4
0 163 20	3.1
0 163 22	3
0 163 25	3.7
0 163 30	4.1
0 163 35	5.4
0 163 40	6.5
0 163 45	7.5
0 163 50	10
0 163 55	12.3
0 168 35	6.6
0 168 40	8
0 168 45	9.4
0 168 50	11.8
0 168 55	14.6
0 168 60	18.1
0 169 35	6.2
0 169 40	7.5
0 169 45	8.5
0 169 50	10.7
0 169 55	13.5
0 173 50	11.8
0 173 55	14.6
0 173 60	18
0 173 65	20
0 174 50	9.6
0 174 55	11.9
0 174 60	14.9
0 174 65	18.7
0 178 60	18.5
0 178 65	20.6
0 178 70	25
0 178 75	28.5
0 179 60	14.5
0 179 65	17.5
0 179 70	23
0 179 75	29
0 181 75	39
0 181 80	47
0 185 80	46.6
0 185 85	70
0 185 90	83.3
0 185 95	110

Industrial blade-type cartridge fuses gG type

Catalogue number(s):

0 163 04/12/18/20/22/25/30/35/40/45/50/55, 0 168 04/35/40/45/50/55/60,
0 169 35/40/45/50/55, 0 173 04/50/55/60/65, 0 174 50/55/60/65, 0 175 60/65/70/75,
0 178 04, 0 179 60/65/70/75, 0 181 04/75/80, 0 185 04/80/85/90/95

How to choose a protection system

- Overload: use the performance data for the various protection devices. The curves must not cross one another in the same circuit.

- Short-circuit: use the integral ($\int I^2 dt$) of the thermal stresses. The total integral for the downstream protection device must be lower than the pre-arc integral for the upstream device.

Selectivity check

Selectivity between cartridge fuses

Upstream gG cartridge fuse rating (A)	Downstream Maximum rating (A) as a function of the usage category and the voltage to obtain selectivity	
	aM	gG
2	-	-
4	1	1
6	2	2
8	2	2
10	2	4
12	2	4
16	4	6
20	6	10
25	8	16
32	10	20
35	12	20
40	12	25
50	16	32
63	20	40
80	25	50
100	36	63
125	40	80
160	63	100
200	80	125
250	125	160
315	125	200
400	160	250
500	200	315
630	250	400
800	315	500
1000	400	630
1250	500	800

Upstream aM cartridge fuse rating (A)	Downstream Maximum rating (A) as a function of the usage category and the voltage to obtain selectivity	
	aM	gG
2	1	1
4	2	4
6	2	6
8	4	8
10	6	10
12	6	12
16	10	16
20	12	20
25	12	25
32	20	32
36	20	32
40	25	32
50	25	40
63	40	50
80	50	63
100	63	80
125	80	100
160	100	125
200	125	160
250	160	160
315	200	200
400	250	250
500	315	315
630	400	400
800	500	500
1000	630	500
1250	800	630

Example of good protection

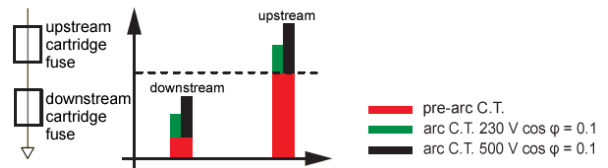

Protection of motors

Motors									Cartridge fuses												
230 V 3-phase			400 V 3-phase			500 V 3-phase			Size 00 ratings		Size 0 ratings		Size 1 ratings		Size 2 ratings		Size 3 ratings		Size 4 ratings		
kW	ch	In A	kW	ch	In A	kW	ch	In A	gG	aM	gG	aM	gG	aM	gG	aM	gG	aM	gG	aM	
0,37	0,5	1,8	0,37	0,5	1,03	0,75	1	1,5													
0,75	1	3,5	1,5	2	3,5	2,2	3	3,8													
1,1	1,5	4,4	2,2	3	5	3,7	5	5,9													
1,8	2,5	7	3	4	6,6	4	5,5	6,5													
2,2	3	8,7	4	5,5	8,5	5,5	7,5	9													
3	4	11,5	5,5	7,5	11,5	7,5	10	12	25												
4	5,5	14,3	7,5	10	15,5	11	15	18,4	32	20											
5,5	7,5	20	11	15	22	15	20	23	50	25											
7,5	10	27	15	20	30	18,5	25	28,5	50	32											
10	13,5	35	18,5	25	37	25	34	39,4	63	40	63										
11	15	39	22	30	44	30	40	45	80	50	80										
15	20	52	25	34	51	40	54	60	100	63	100	63									
18,5	25	64	30	40	60	45	60	65	125	80	125	80	125								
22	30	75	37	50	72	51	70	75	125	80	125	80	125								
25	35	85	45	60	85	63	109	89	160	100	160	100	160								
30	40	103	55	75	105	80	110	112		125	200	125	200	125	200						
45	60	147	75	100	138	110	150	156			160	250	160	250							
55	75	182	90	125	170	132	180	187				200	315	200							
75	100	239	110	150	205	160	220	220				250	400	250							
80	160	260	132	180	245	220	300	310						315							
90	125	295	160	218	300									315							
110	150	356	200	270	370	250	340	360						400							
132	180	425	250	340	475	335	450	472													
160	218	520	315	430	584	450	610	608											500		
220	300	710	400	550	750	500	680	680											630		
																				800	

(1) 400 V maximum

Industrial blade-type cartridge fuses gG type

Catalogue number(s):

0 163 04/12/18/20/22/25/30/35/40/45/50/55, 0 168 04/35/40/45/50/55/60,
0 169 35/40/45/50/55, 0 173 04/50/55/60/65, 0 174 50/55/60/65, 0 175 60/65/70/75,
0 178 04, 0 179 60/65/70/75, 0 181 04/75/80, 0 185 04/80/85/90/95

2.4. Dimensions

2.4.1 Cartridge fuses with indicator (without striker):

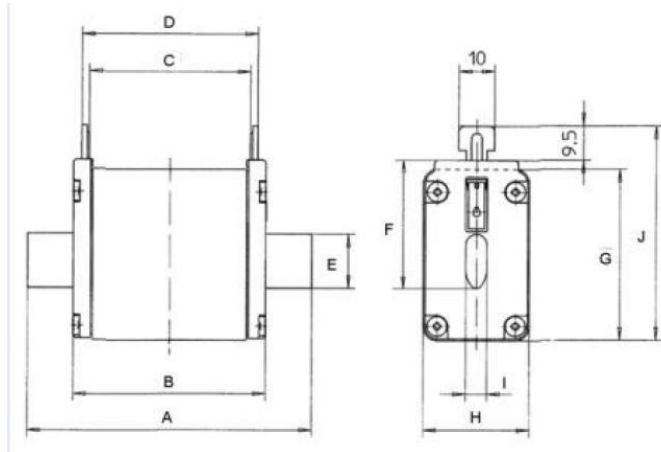

Size	A	B	C	D	E	F	G	H	I	J
00	79	48.5	44	48	15	35.8	47.8	30	6	59
0	125	62.5	60	64	15	35.8	48	30	6	59
1	135	68	62	68	20	40	52.6	39	6	64
2	150	68	62	68	26	48	60	51.5	6	72

2.4.2 Cartridge fuses with striker:

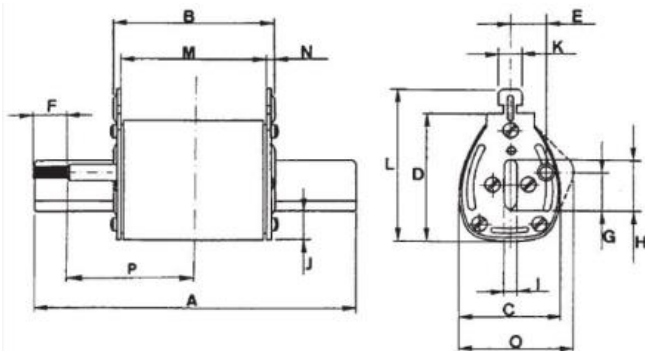

Size	A	B	C	D	E	F	G	H
0	124,5	66	39	49	14,5	15,5	14	15
1	134,5	67	40	55	16	15,5	14,5	20
2	150	67	56	62,5	19	15,5	14,5	26
3	150	67	69	76	24	15,5	14,5	32
4	200	68	90	108	27	16,5	14,5	49

Size	I	J	K	L	M	N	O	P
0	6	14	10	59	60	3	41,5	47
1	6	14	10	65	61	3	45	52
2	6	15	10	72,5	61	3	-	60
3	6	16	10	86	61	3	-	60
4	8	20	10	118	62	3	-	72

3. COMPLIANCE

Comply with IEC 60269-1,2 and 2-1 and VDE 0636-21

4. ACCESSORIES

• Bases

Size	Current (A)	1 pole		3 poles
		Bare	With miniswitch	Bare
00	100A 160 A	0 199 42 0 199 44	-	0 199 43 0 199 45
0	160	0 199 46	0 199 47	To be made up with 1 Pole + accessories
1	250	0 199 48	0 199 49	
2	400	0 199 50	0 199 51	
3	630	-	0 199 52	
4	1250	-	0 199 53	

• Handle cat. no.: 0 199 02

(in mm)

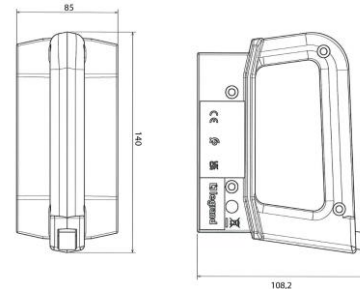

• Neutrals

Rated current:

Cat. No.	0 163 04	0 168 04	0 173 04	0 178 04	0 181 04	0 185 04
Size	00	0	1	2	3	4
In (A)	125	160	250	400	630	1000

Size 00 cat. no.: 0 163 04

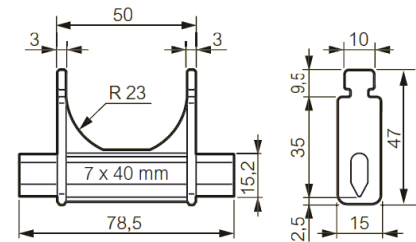

Sizes 0 to 4:

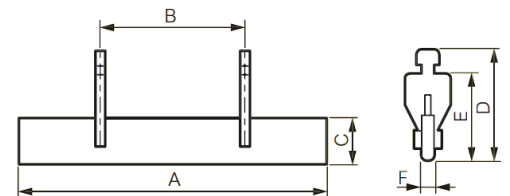

Dimensions in mm:

Cat. No.	0 168 04	0 173 04	0 178 04	0 181 04	0 185 04
Size	0	1	2	3	4
A	125	135	150	150	200
B	65	65	65	65	65
C	15	20	26	38	50
D	45	50	58	66.5	78
E	35	40	48	56.5	68
F	6	6	6	6	6

Industrial blade-type cartridge fuses gG type

Catalogue number(s):

0 163 04/12/18/20/22/25/30/35/40/45/50/55, 0 168 04/35/40/45/50/55/60,
0 169 35/40/45/50/55, 0 173 04/50/55/60/65, 0 174 50/55/60/65,
0 175 60/65/70/75, 0 178 04, 0 179 60/65/70/75, 0 181 04/75/80,
0 185 04/80/85/90/95

5. CURVES

5.1: Cartridge fuses with indicator (without striker):

Fusion curve:

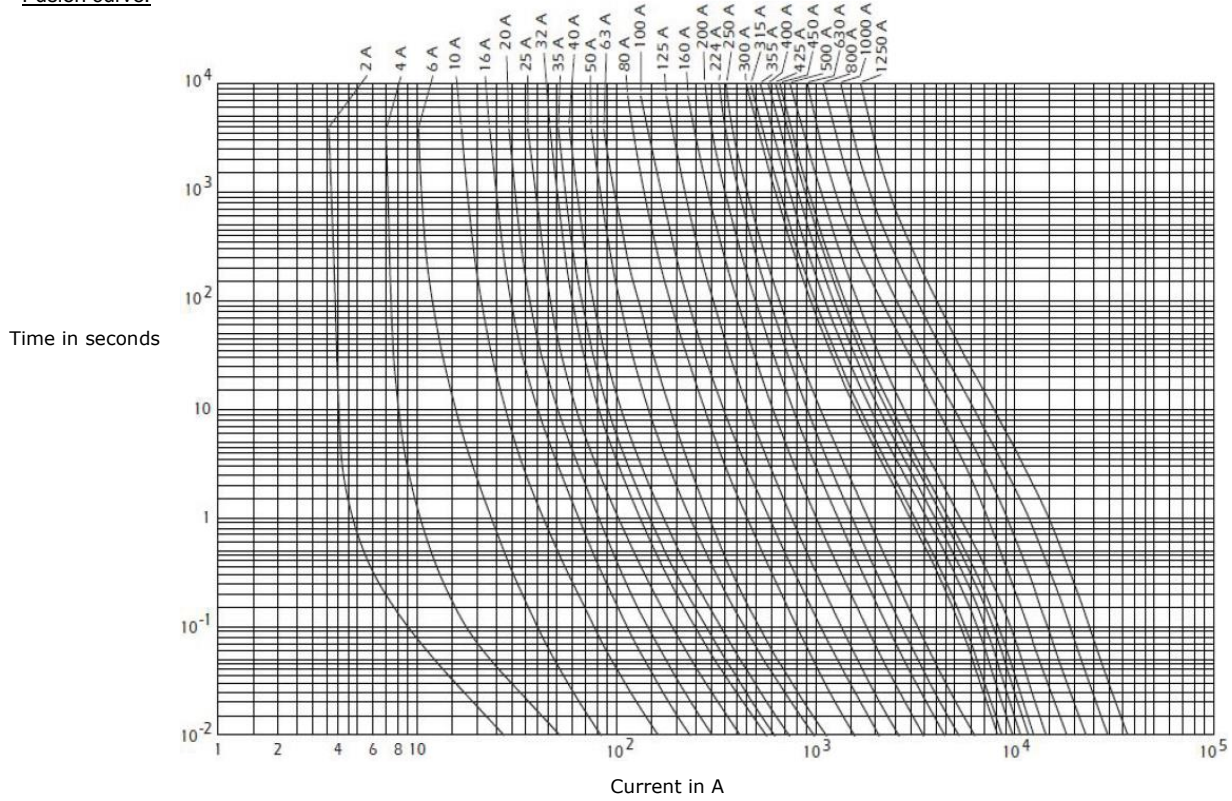

Thermal stresses:

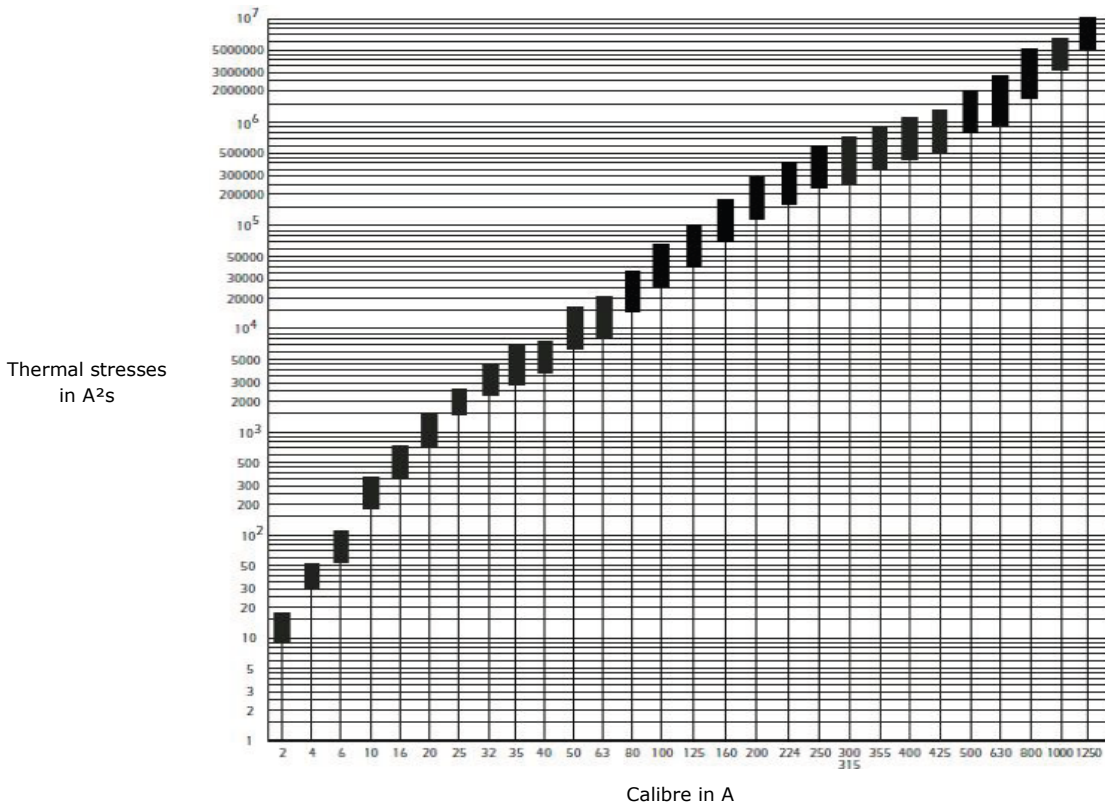

Industrial blade-type cartridge fuses gG type

Catalogue number(s):
 0 163 04/12/18/20/22/25/30/35/40/45/50/55, 0 168 04/35/40/45/50/55/60,
 0 169 35/40/45/50/55, 0 173 04/50/55/60/65, 0 174 50/55/60/65,
 0 175 60/65/70/75, 0 178 04, 0 179 60/65/70/75, 0 181 04/75/80,
 0 185 04/80/85/90/95

Limitation curve:

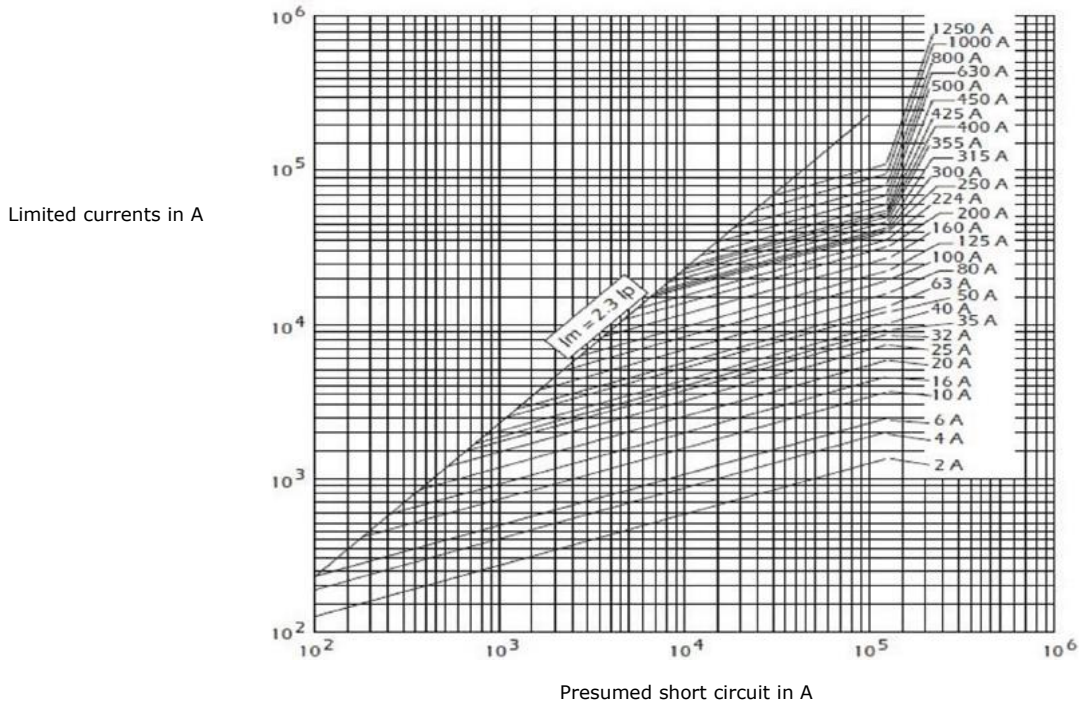

5.2: Cartridge fuses with striker:

Fusion curve:

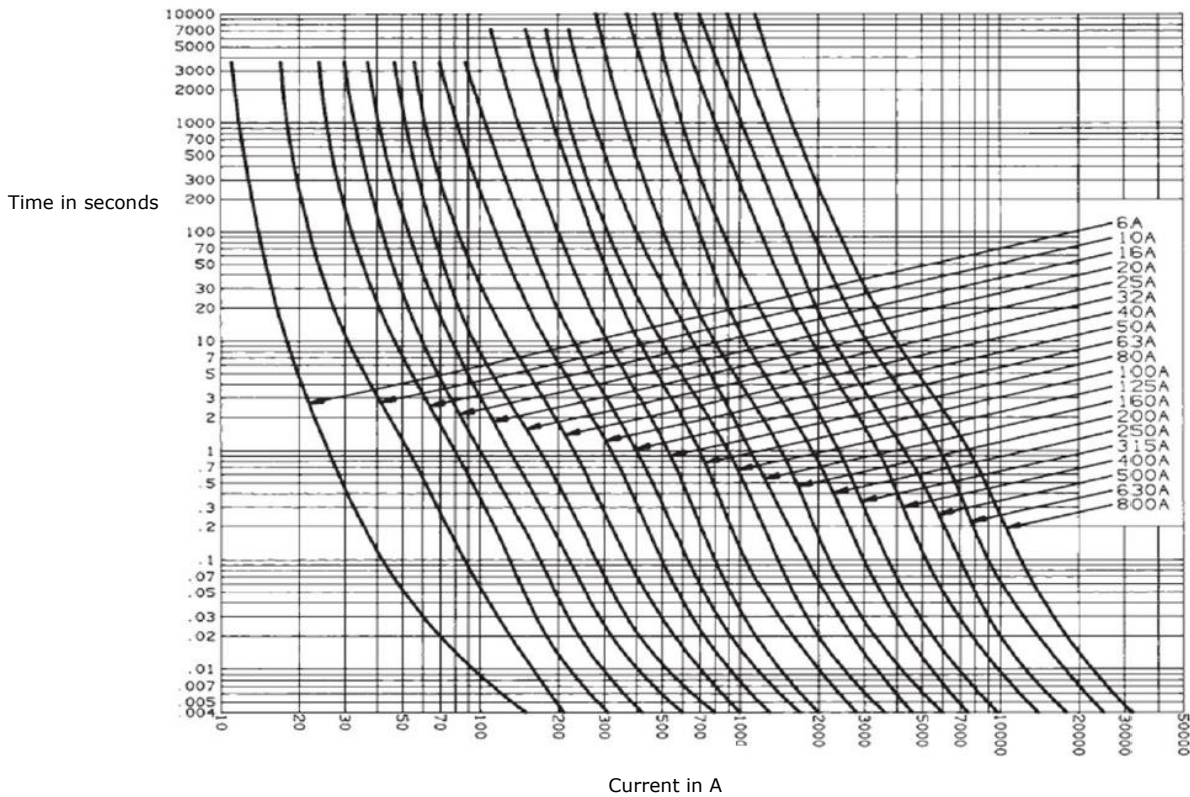

Industrial blade-type cartridge fuses gG type

Catalogue number(s):
 0 163 04/12/18/20/22/25/30/35/40/45/50/55, 0 168 04/35/40/45/50/55/60,
 0 169 35/40/45/50/55, 0 173 04/50/55/60/65, 0 174 50/55/60/65,
 0 175 60/65/70/75, 0 178 04, 0 179 60/65/70/75, 0 181 04/75/80,
 0 185 04/80/85/90/95

Thermal stresses:

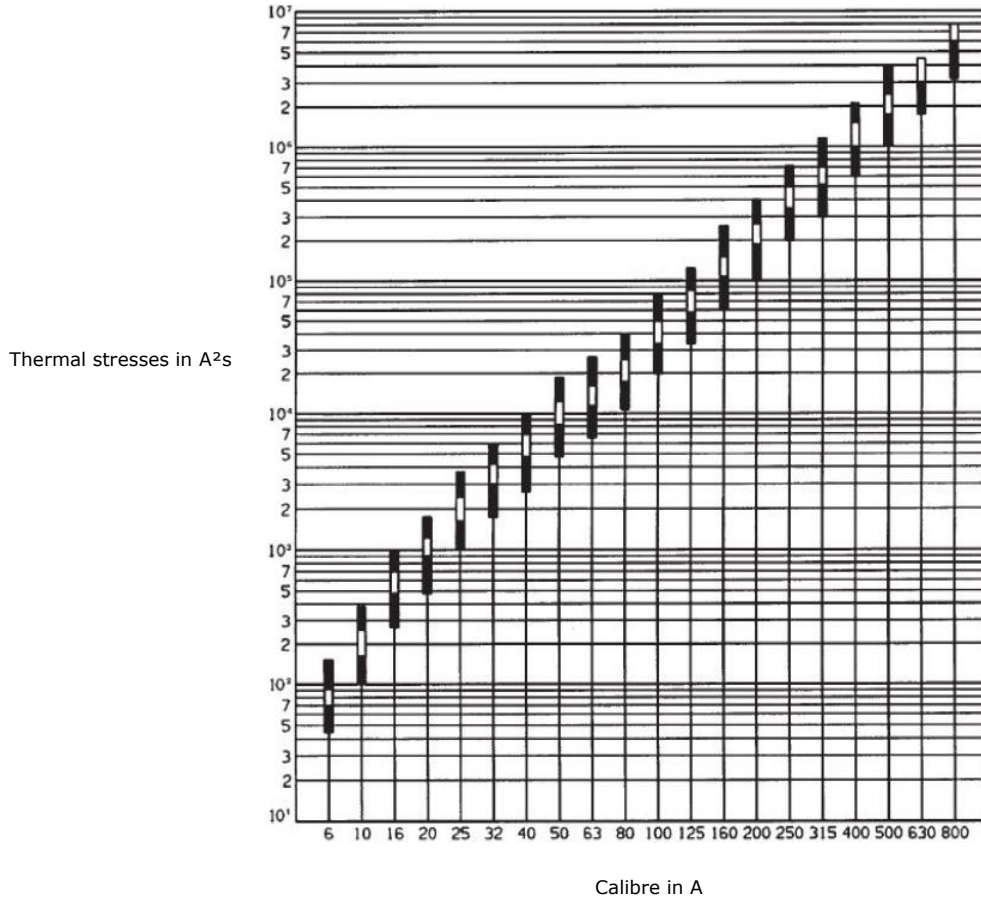

Limitation curve:

