

	<ul style="list-style-type: none"> • 100 - 240 V~ • 100 - 240 Volt~ 		-5°C / 30°C		<ul style="list-style-type: none"> • PIR (Passive Infra Red) • IV • IR • PIR (인체감지)
	50 / 60 Hz		2000 LUX		<ul style="list-style-type: none"> • Ø 14 m • Ø 14 meter
	2 x 1.5mm² / 1 x 2.5mm²		10s		
	7 mm				

LED															
240 V~	350 VA	3 A	2000 W	8.5 A	1000 VA	10x(2x36 W)		4.3 A	4.3 A	I ≤ 2A	500 VA	1000 VA		2.1 A	4.3 A
100 V~	175 VA		1000 W		500 VA	5x(2x36 W)					250 VA	500 VA			

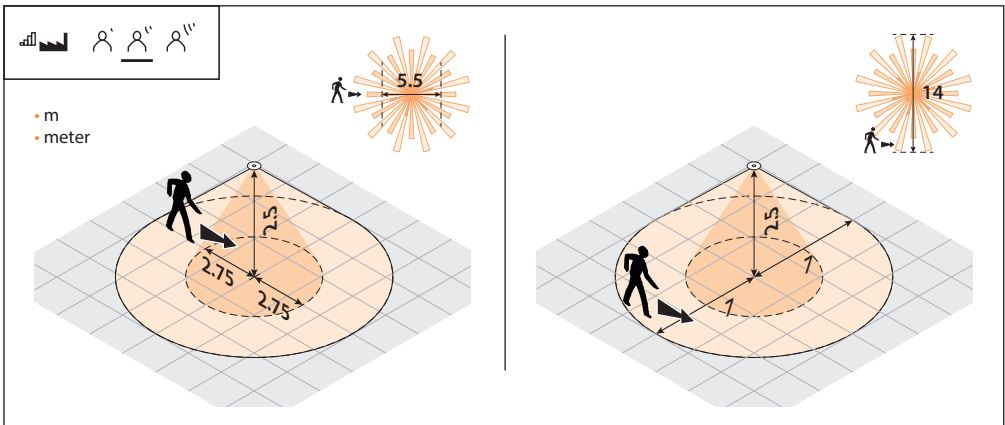

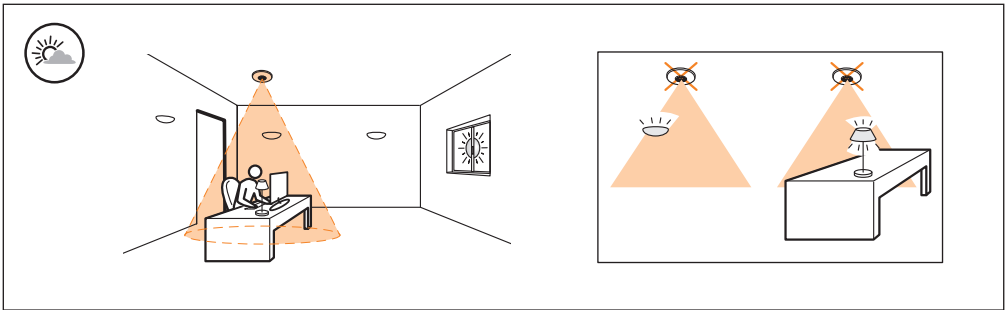
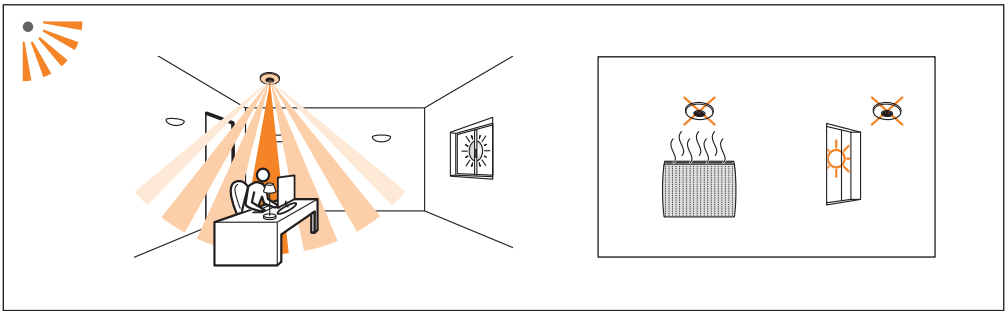
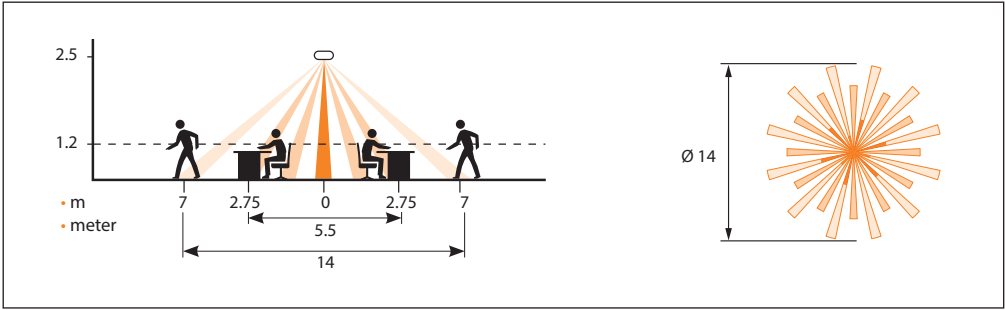
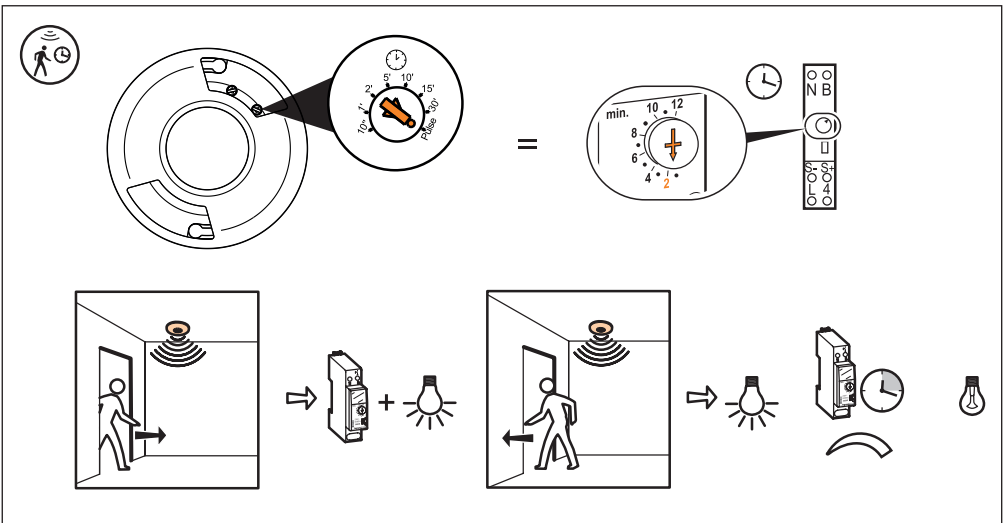
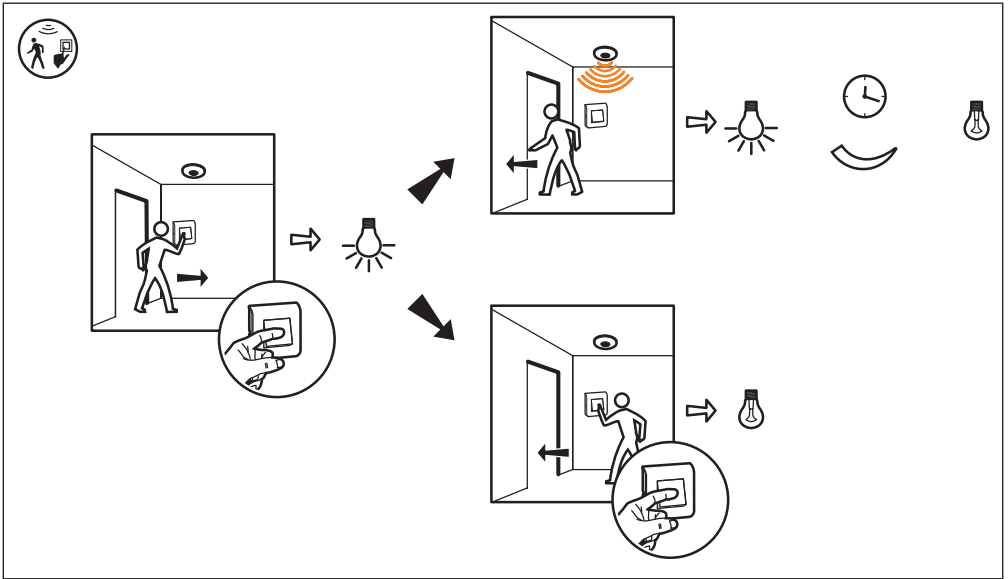
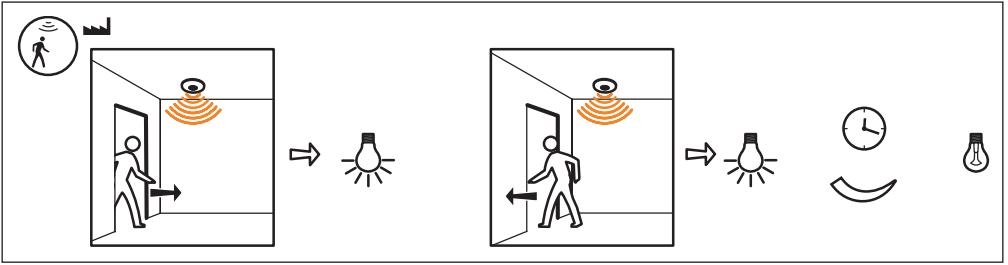

1

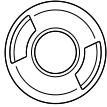

2

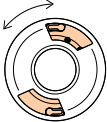

3

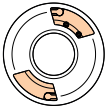

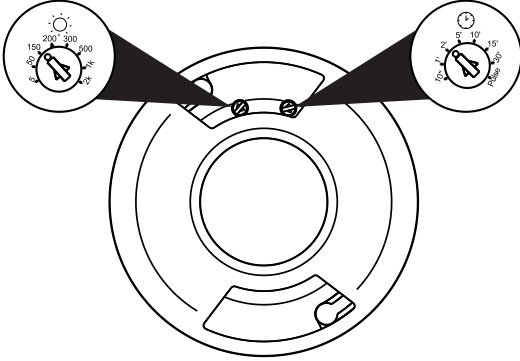

☀ lux
5
50
150
200
300
500
1 k
2 k

🕒
10"
1'
2'
5'
10'
15'
30'
Pulse

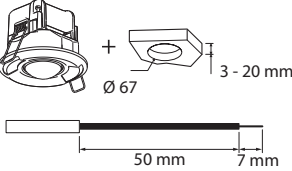

Ø 67

3 - 20 mm

50 mm

7 mm

